

Republic of the Philippines
Office of the President

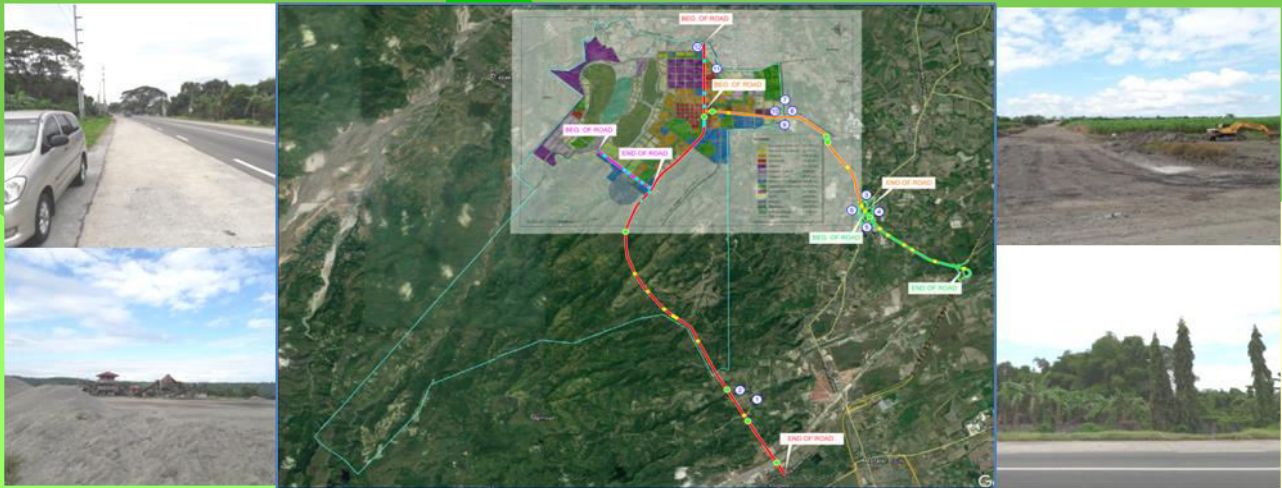

Consulting Services for the Detailed Engineering Design of the Proposed Airport-CGC Access Road, MacArthur-CGC Access Road, MacArthur-SCTEX Access Road and Olympic Village Access Road



BIDDING DOCUMENTS **VOLUME III** TECHNICAL SPECIFICATIONS AIRPORT TO NCC ROAD SECTIONS (Sta. 1+500.00 to Sta. 16+000.00)

PACKAGE - 3 FINAL

MARCH 2018



URBAN INTEGRATED CONSULTANTS, INC.
Engineers • Project Managers • Planners • Environmentalists • Economists
UICI Corporate Bldg., 8 Lands Street, VASRA, Diliman, Quezon City, 1128

TABLE OF CONTENTS

ITEM NO.	DESCRIPTION	PAGE NO.
PART A	FACILITIES FOR THE ENGINEER	A-1
A.1	Requirements	A-1
A.1.1	Offices and Living Quarters for the Engineer	A-1
A.1.1.2	Operation and Maintenance of Office and Living Quarters	A-2
A.1.1.3	Staffing for Engineer's Facility	A-3
A.1.1.4	Furniture, Fixtures, Appliances and Equipment for the Office and Living Quarters of the Engineer	A-3
A.1.1.5	Quality Control and Testing Centers	A-4
A.1.2	Vehicles for the Engineer	A-4
A.1.2(5)	Operation and Maintenance of the Vehicles for the Engineer	A-5
A.1.3	Assistance for the Engineer	A-6
A.1.4	Progress Photographs	A-7
A.1.5	Communication Facility	A-8
A.1.6	Schedule of Facilities for the Engineer	A-8
A.1.1(11)	Schedule for the Provision of Furniture/Fixtures, Equipment and Appliances for the Engineer's Field Office	A-9
A.1.1(13)	Schedule for the Provision of Furniture/Fixtures, Equipment and Appliances for the Living Quarters of the Engineer	A-10
A.2	Measurement and Payment	A-14 to A-16
PART B	OTHER GENERAL REQUIREMENTS	B-1
B.1	Offices, Shops, Stores and Workmen's Accommodation for the Contractor	B-1
B.2	Medical Room and First Aid Facilities	B-1
B.3	Quality Control of Materials	B-2
B.4	Construction Survey and Staking	B-6
B.4.3	Centerline Reestablishment	B-9
B.4.4	Culvert Survey and Staking	B-10
B.4.5	Bridge Survey and Staking	B-10
B.4.6	Retaining Walls and Other Types of Slope Protection Works Survey	B-11
B.4.7	Grade Finishing Stakes	B-11
B.4.8	Permanent Monuments and Markers	B-11
B.5	Project Sign Board	B-13
B.6	Transportation and Handling	B-13
B.6A	Provisions For Passage of Traffic	B-15
B.6B	Disposal of Materials Outside the Project Boundaries	B-16
B.6C	Project Record Documents	B-16
B.7	Construction Occupational Safety and Health Program	B-19
B.8	Traffic Management During Construction	B-21
B.9	Mobilization/Demobilization	B-28
B.10	Method of Measurements	B-29
B.11	Silence of Contract Documents	B-32
B.12	Meetings/Conferences	B-33
B.13	Measurement and Payment	B-33

TABLE OF CONTENTS

ITEM NO.	DESCRIPTION	PAGE NO.
PART C	EARTHWORK	C-1
100	Clearing and Grubbing	C-1
102	Excavation	C-4
103	Structure Excavation	C-10
104	Embankment	C-15
105	Subgrade Preparation	C-24 to C-27
PART D	SUBBASE AND BASE COURSE	D-1
200	Aggregate Subbase Course	D-1
201	Aggregate Base Course	D-4
202	Crushed Aggregate Base Course	D-6 to D-9
PART E	SURFACE COURSES	E-1
301	Bituminous Prime Coat	E-1
310	Bituminous Concrete Surface Course, Hot-Laid	E-3
311	Portland Cement Concrete Pavement	E-9 to E-34
PART F	BRIDGE CONSTRUCTION	F-1
400	Piling	F-1
400(27)a	Pile Integrity Testing	F-19
400(28)	Pile Dynamic Testing	F-20
401	Railings	F-22
404	Reinforcing Steel	F-25
405	Structural Concrete	F-28
406	Prestressed Concrete Structures	F-38
407	Concrete Structures	F-47
412	Elastomeric Bearing Pads	F-65
507	Rubble Concrete	F-69
517	Drain Pipe	F-71
508	Hand Laid Rock Embankment	F-73
SPL-801	Pre-molded Expansion Joint Filler with Sealant	F-73
PART G	DRAINAGE AND SLOPE PROTECTION STRUCTURES	G-1
500	Pipe Culverts and Storm Drains	G-1
502	Manholes, Inlets and Catch Basins	G-2
505	Riprap and Grouted Riprap	G-3
506	Stone Masonry	G-5 to G-6
PART H	MISCELLANEOUS STRUCTURES	H-1
600	Curb and Gutter	H-1
601	Sidewalk	H-5
602	Monuments, markers and Guide Posts	H-7

TABLE OF CONTENTS

ITEM NO	DESCRIPTION	PAGE NO.
PART H		
603	Guardrail	H-8
604	Fencing	H-10
605	Road Signs	H-12
612	Reflective Thermoplastic Stripping Material (Solid Form)	H-14
613	Concrete Joint Sealant (Hot Poured Elastic Type)	H-19
618	Reflectorized Thermoplastic Rumble Strips	H-21
622	Bio-Engineering Solutions (Coconet)	H-24
SPL-1200-1	Bikeway Paving (Reinforced Concrete with Exposed Glow In the Dark Aggregates Finished)	H-26 to H-28
PART J		
103(1)a	STREETLIGHTS AND LIGHTINGS	J-1
104(7)	Structure Excavation (Streetlight Concrete Pedestal)	J-1 to J-12
SPL-1000(3)	Structure Backfill (From Common Excavation)	
SPL-1100-1	Construction of Steel Pole Concrete Pedestal, including Rebars and Anchor Bolts w/ nut & Washer 25mm x 762mm	
SPL-1100-2	Supply & install, 12.0m. HIGH STEEL LIGHTING POLE, 3.0m - Single Arm , including Ground Rod w/ Clamp	
SPL-1100-3	Supply & install, 12.0m. HIGH STEEL LIGHTING POLE, 3.0m – Double Arm, including Ground Rod w/ Clamp	
SPL-1100-4	Supply & install, 120W LED Roadway Luminaire, Post Mounting with Copper Split bolt Connector	
SPL-1100-5	Supply & Install, THW Copper Wire, 22mm ²	
SPL-1100-6	Supply & Install, THW Copper Wire, 8mm ²	
SPL-1100-7	Supply & Install, THW Copper Wire, 3.5mm ²	
SPL-1100-8	Supply & Install, 50mm Ø PVC Pipe with Coupling	
SPL-1100-9	Supply & Install, Enclosed Circuit Breaker, 2P40A 22KAIC, NEMA-4x with 50mm HUB	
SPL-1100-10	Supply and Install, Panel Board, MCB: 4P100AT; BRS:10-2P40AT; NEMA-4x	
SPL-1100-11	Supply and Install Synchronizing Panel, 3-45KVA, 3Ø, 400V, 60HZ. PLC	
SPL-1100-12	Supply and Install Generator Set, Diesel, 45KVA, 3Ø, 400V, 60HZ. Brushless	
SPL-1100-13	Construction of Powerhouse Building, 4m x 6m Floor Area	
SPL-1100-14	Standard Electrical Handhole, for Service Lateral Connection	
SPL-1100-15	Supply and Install Metered Electric Utility Services for 45KVA, 3Ø, 400V	
	Contingency Miscellaneous	
PART K		
	STREET LANDSCAPE	K-1
	Scope of Works/Description and Materials	K-1 to K- 27

PART A

FACILITIES FOR THE ENGINEER

PART A. FACILITIES FOR THE ENGINEER**A.1 REQUIREMENTS****A.1.1 Offices and Living Quarters for the Engineer****A.1.1.1 Offices and Living Quarters for the Engineer**

The Contractor shall provide and maintain until final completion of the project a one (1) unit field office building, and two (2) units of rented living quarters for the exclusive use of the Engineer and his staff. The office shall have at least 180 square meters in floor area, rectangular and made of concrete finished walls and partitions, G.I. roofing, glass windows and hard wooden doors, ply board ceilings, tiled floors, with complete sanitary connections and sewage connection to a septic tank, complete with electrical installation. This office building shall contain the supplies, appliances, equipment and furnishings specified in the Contract. The location and final plan of the office building shall require the approval of the Engineer prior to the start of the construction, while the rented living quarter shall also require the approval of the Engineer prior to the selection of the unit for lease. It is the intent of this Specification to locate the field office building in a government owned lot so that the use by the government of this facility can be maximized even after the completion of the project. However, if no government lot is available, and this structure are to be erected on private property, it is the responsibility of the Contractor to make necessary arrangements with the landowner(s) regarding the use of the lot for the Engineer's office and to remove and transfer, if so required under the Contract, the improvements thereon, including all appurtenances upon completion of the Works.

The office building shall be constructed in accordance with the approved Plans and Drawings which will be proposed and prepared by the Contractor and approved by the Engineer. It shall be at locations designated and oriented to the approval and satisfaction of the Engineer. All cost of labor, materials, equipment and ground rentals that maybe considered necessary for the construction of such facility shall be at the expense of the Contractor.

The field office and living quarters shall be provided with all the necessary electricity, telephone line, potable water supply, sewer and drainage services for twenty-four (24) hours a day. This office and living quarters must be ready for occupancy and use of the Engineer within two (2) months of the commencement of the Works. This is specified in Part A; Item A.1.1 (3), and Item A.1.1 (10).

However, if there will be delay in the provision of such facilities, the Contractor shall provide temporary facilities in rented building(s) conforming to all the requirements of the permanent facilities to the satisfaction of the Engineer. The Contractor shall maintain such temporary facilities for the Engineer over the same period.

All facilities provided by the Contractor shall conform to the best standard of the required types. On the completion of the Contract, these facilities (except those on rental basis) provided by the Contractor including utilities and communication facilities shall be

turned-over to the BCDA including office equipment, apparatus, pieces of furniture and furnishing, etc., unless otherwise directed by the Engineer.

The facilities provided by the Contractor shall be near the job site, where necessary and shall conform to the best standard for the required types. On the completion of the Contract, the facilities provided by the Contractor including utilities and communication facilities shall revert to the Government including office equipment, pieces of furniture, apparatus, appliances unless otherwise specified in the Contract documents.

The Contractor shall fence the office building with barbed wire (or equivalent), 1.8 meter high with necessary gates as directed by the Engineer. The Contractor shall raise the grade of the Engineer's facility (if necessary) and will provide drainage in the vicinity, with suitable access walkways, seeding and sodding of the ground as directed and approved by the Engineer. The facilities shall be provided with a parking area for at least eight (8) vehicles and a satisfactory access road to the parking area. Outside lighting around the facility and parking areas shall be installed to the satisfaction of the Engineer and be maintained at all times. Appropriate signs shall be erected to inform the public of the purpose of the facility.

The Contractor shall be responsible for the maintenance and protection of all facilities to be provided during the duration of the Contract, including providing adequate stock of all expendable items, such as light bulbs, light tubes and consumable stores at all times to ensure proper and continuous functioning of all the Engineer's Facilities.

All windows and door openings of all buildings/facilities shall be wire screened for insect protection.

The Contractor shall be responsible for all the materials quality control and laboratory tests needed in the execution the Works. The Contractor must submit for the approval of the Engineer the possible accredited materials and laboratory testing centers that will conduct the necessary tests needed. The Contractor shall also assign a qualified and experienced laboratory staff and Material Engineer to carry out, transport the specimen to the Accredited Laboratory Centers and testify on all the materials quality control tests as specified in the Contract and required by the Engineer. The person so appointed by the Contractor to manage the laboratory works and to be present during the actual testing shall be well experienced in the type of work to be undertaken and shall be subject to the approval of the Engineer. He shall work full time and shall be responsible to the Engineer for all works carried out.

A.1.1.2 Operation and Maintenance of Office and Living Quarters

The Contractor is required to maintain and protect the Engineer's field office, living quarters and all utilities therein in good condition throughout the whole period for which the facility is required and to repair and/or replace broken items that become defective in any way. Should the Contractor fail to maintain, repair or replace any item when such is required or fail to supply any material, article or thing

necessary within the time to be specified by the Engineer, the Engineer may deal with the matter himself in whatever manner he considers most appropriate, and all costs thereby incurred by the Engineer shall be recoverable from the Contractor and may be deducted from any money which is due or which may become due to the Contractor.

The Contractor shall provide and pay for all connection charges in respect of electricity, water, telephones and communication facilities. Electricity and water consumption costs and the cost of telephone services and calls shall be paid for by the Contractor.

The Contractor shall provide emergency generators or power generating units with enough capacity to supply the power needed in case of local power failure. For potable water requirement, the Contractor shall furnish drinking water dispenser with purifier, including daily supply of loaded mineral water containers, to the satisfaction of the Engineer.

In addition, the Contractor shall provide the following personnel for the Engineer's facilities:

- One (1) - Messenger/ Utility man
- Two (2) - Security Personnel

The Contractor shall provide protective clothing, waterproof clothing, rubber boots, and safety helmets for the site staff.

All office and living quarters and its surroundings shall be proficiently guarded at all times of the day and night, regularly and properly cleaned, adequately supplied and maintained for the duration of the Contract.

The above are specified in Part A, Item A.1.1 (16) and Item A.1.1 (18).

A.1.1.3 Staffing for Engineer's Facilities

All staff for the Engineer's office and living quarters, such as janitors, maintenance personnel, security staff, service drivers and support staff shall be provided by the Contractor and approved by the Engineer.

All staff assigned as assistance for the Engineer is defined in **Part A.1.3.- Assistance to the Engineer** and in Item A.1.3 (3).

A.1.1.4 Furniture, Fixtures, Appliances and Equipment for the Office, and Living Quarters of the Engineer

The Contractor shall, within thirty (30) calendar days after receipt of Notice to Proceed, will furnish the field office and living quarters with sufficient furnitures, fixtures, equipment, appliances and necessary supplies and consumable stores as specified in Items A.1.1(16), and Item A.1.1(18) hereunder to the satisfaction of the Engineer.

All furnitures, fixtures, appliances and equipment specified herein to be provided as specified in Item A.1.1(11) and Item A.1.1(13) hereunder and other items to be purchased for the use of the

Engineer shall be brand new when initially furnished and shall conform with those indicated in the Specifications as to kind, type and size or as determined by the Engineer.

The Contractor shall ensure that the furnitures, fixtures, furnishings, equipment and appliances therein are properly maintained and, if any problem arises, shall rectify the matter himself and shall not wait for the occupants of the property to take action if it is obvious that a delay in dealing with the matter would otherwise occur. All costs in connection with providing adequate maintenance shall be borne by the Contractor.

It shall be understood that if the Contractor cannot provide the articles as specified or intends to supply equivalent substitutes, the Contractor should secure the approval of the Engineer and if such approval is granted, it will be on the condition that adjustments in prices will be effected based on the submitted receipt invoices of the Contractor.

A.1.1.5 Quality Control and Testing Centers

All material laboratory tests and quality control tests shall be performed by the Contractor through an accredited material testing centers duly approved by the Engineer. The payment and costs of all the necessary tests shall be borne by the Contractor and understood to have been incorporated in all his contract unit price analysis. No extra payment for the said tests will be entertained.

A.1.2 Vehicles for the Engineer

A.1.2 (2) Provision of Vehicles for the Engineer (On Rental Basis)

Within fifteen (15) days after the Commencement Date, the Contractor shall provide and deliver to the Site, the following brand new vehicles on rental basis for the exclusive use of the Engineer, the Engineer's assistants, staff and representatives working on the Site:

3 units 4WD Pick-Up Type, Double Crew Cab, Service Vehicle, 2200cc, Diesel Engine with factory installed air-conditioner

The Contractor shall submit catalogues in the English language of the proposed rented vehicles to the Engineer for his approval within seven (7) days after the Commencement Date, and the final consent for the delivery of the rented vehicles on site shall be to the satisfaction of the Engineer.

All vehicles shall carry or be fitted with all tools and accessories as maybe prescribed by laws and with comprehensive insurances. They shall also be complete with seat belts for all seats, and shall be supplied with first aid kits, fire extinguishers, detachable magnetic flashing orange warning lights, accident warning triangles and any other safety kit requirements.

In case the Contractor fails to provide the aforesaid vehicles on the date required, the Engineer shall take such action as he deemed necessary, to acquire the usage of such vehicle and charge all relevant expenses to the Contractor.

The vehicles may be used by the Engineer and/or the Employer both on and off the site and outside the project area, both for business purposes during working hours and in other official purposes.

The rented vehicles shall be duly registered in the name of owner with all proper ownership documents kept by the Contractor together with a copy of contract of lease executed by the Contractor and the owner of the vehicle. These documents must be also furnished to the Engineer. Accordingly, when the assignments of the Engineer's and Employer's personnel in connection with the execution of the Works have been completed, the vehicles shall be returned to the Contractor.

A.1.2 (5) Operation and Maintenance of the Vehicles for the Engineer

A.) Driver of Vehicles for the Engineer

Each vehicle shall be driven by a competent, qualified and experienced driver recruited and paid for by the Contractor, including overtime payments and the like. All such drivers shall be under the direct full-time control of the Engineer.

All drivers shall be:

- properly licensed, with demonstrable previous experience in driving in and under conditions prevailing on a major civil engineering construction site;
- able to read, write and speak English
- available to work any hour on any day of the week
- have the requisite flexibility to meet demands for their services at any time by the Engineer for any purpose under the Contract.

The Contractor shall manage and monitor the performance of drivers to ensure the provision and maintenance of drivers with a high level of skill and a demonstrated ability to drive efficiently and safely. Drivers not meeting these criteria shall be promptly replaced by the Contractor when so directed by the Engineer.

B.) Operation and Maintenance of Vehicles

The Contractor shall be solely responsible for all activities related to the procurement of the vehicles and for the registration of the vehicles, their annual road license/taxes and the provision of passes, access stickers and the like, as well as for providing fully comprehensive insurance until and including the date of issue of the Taking-Over Certificate; all costs thereof being at the Contractor's expense which is incorporated accordingly on his bare rental payments.

The Contractor shall maintain the vehicles in first class condition and shall be supplied with appropriate fuel and lubricants at all times. He shall also undertake entirely all servicing and maintenance requirements for the vehicles, including regularly cleaning inside and out and providing all such replacement parts as maybe from time to time become necessary. This is provided as specified in Item A.1.2 (5) Operation and Maintenance of the Vehicles for the Engineer.

The Contractor shall provide equivalent substitute vehicles during the period when specified vehicles are taken out of service due to

breakdown, for servicing, for maintenance, repair or any other reason.

Should the Contractor fail to maintain, repair or replace any vehicle when such is required, the Engineer may deal with the matter himself in whatever manner he considers most appropriate, and all costs thereby incurred by the Engineer shall be recoverable from the Contractor and may be deducted from any money which is due or which may become due to the Contractor.

The vehicles shall comply in all respect, with all relevant Philippine national or local laws, statutes and regulations.

A.1.3 Assistance for the Engineer

A.1.3 (3) Provision of Survey Personnel for the Assistance to the Engineer

The Contractor shall provide and employ qualified survey personnel, chainmen and laborers for the assistance to the Engineer as required for in the execution of the Works. These personnel will keep and maintain with confidentiality all information and records of the measurements on site for the whole duration of the Contract. These Contractor's supplied personnel are subject for approval of the Engineer. This is specified in Item A.1.3(1) Provision of Survey Personnel for the Assistance to the Engineer.

Numbers of minimum required survey personnel are as follow;

- One (1) - Survey Engineer
- Two (2) - Instrument man (Junior Surveyor)
- Four (4) - Chainmen
- Eight (8) - Survey Aides

A.1.3 (2) Provision of Survey Equipment for the Assistance to the Engineer (Contractor's owned)

The Contractor shall at all times during the duration of the Contract provide for the use of the Engineer all equipment, instruments and apparatus, all information and records required by the Engineer for inspecting and measuring the Works. This survey equipment, instruments and apparatus are understood to be owned by the Contractor from the start of the Contract and no separate payment shall be made in respect of the provision and use of such survey equipment, instruments and apparatus as this is deemed to be included in the pay item for each work to be carried out.

Survey equipment, instruments and apparatus of approved type and for the use of the Engineer shall be available within fifteen (15) days from commencing the Works. The minimum requirements are as follows;

- 1 - Total station with tripod including prism
- 2 - Automatic level complete with tripod
- 2 - Leveling rods
- 6 - 100 m. steel band tape
- 6 - 50 m. steel tape
- 6 - Range Poles (3 m long)
- 2 - Hand level

- 6 - Claw Hammers
- 10 - Survey Umbrellas
- 1 Lot - Waterproof clothing (coat, rubber boots and hard hat)
- 10 - 3 meter steel tapes

The Contractor shall supply wooden pegs, stakes, concrete blocks, survey monuments, steel pins, paints, hammers, saws, Engineer's field books, metal templates, straight edges, etc., to enable proper setting out and checking of the works.

A.1.3 (3) Provision of Laboratory Personnel for the Assistance to the Engineer

The Contractor shall provide qualified and experienced laboratory staff to carry out all the materials quality control and all the tests specified in the Contract and required by the Engineer. The personnel that will be appointed by the Contractor to assist the Engineer and to manage all material extractions, testing procedures and to bring field samples to the Accredited Material Laboratory Testing Centers shall be well experienced in the type of works and tests to be undertaken and shall be all subject to the approval of the Engineer. They shall work full time and shall be responsible to the Engineer for all works carried out. The following personnel are;

- One (1) - Materials Engineer
- One (1) - Senior Laboratory Technician
- Six (5) - Laboratory Aide
- One (1) - Secretary/Encoder

These supplied laboratory personnel shall be totally Contractor's crew assigned for the above purpose and no separate payment shall be made in respect of the time, days and works rendered by those personnel as this is deemed to be included in the pay item for maintenance of Engineer's facility.

A.1.4 Progress Photographs

A.1.4 (1) Provision of Progress Photographs

The Contractor shall provide a photographic record of the construction activities. Such photographs shall be taken when and where as directed by the Engineer at intervals of not more than one month or as required, taken selectively by the Engineer, which represents the progress of the Works.

The photographs shall be sufficient in number and location to record the exact progress of the Works. Such photograph shall be taken as per instruction of the Engineer or under the following occasions or events;

- 1) When a portion of the work is difficult or impossible to inspect at the time of a particular operation, where a portion will be covered by backfill, or filling materials after completion and acceptance of the work by the Engineer.
- 2) When or where special or unusual features of the work or latent conditions on the site are present.

When taking the photographs, the Contractor is required to observe the following;

- 1) An indicator such as scale, pole or similar item shall be placed thereon to signify or illustrate the relative dimensions of the pictures.
- 2) Each picture shall be captioned and identified as to date, location, description of the work in progress or completed operation or activity or presence of unusual features.
- 3) Each picture shall be properly referenced.
- 4) The picture shall be clearly discernible in color having a dimension of not less than 12.5cm x 9cm (DPWH DO No. 55, Series of 1994).

The photographs selected by the Engineer, which shall have his signature with copies furnished by the Contractor, shall be compiled in albums provided by the Contractor for the purpose and shall be so arranged in consecutive order in accordance with the construction program submitted to and approved by the Engineer. Each album shall show the name of the Project on the cover and shall contain a location map of the construction site.

All photographs retained by the Engineer shall become the property of the BCDA. A set of photographs shall consist of ten (10) proof prints of each photograph taken per month.

A.1.5 Communication Facility

A.1.5(1) Communication Equipment

The Contractor shall provide within fifteen (15) calendar days upon commencement of the Works and maintain for the duration of the Contract, six (6) sets of new portable cellular phones for use of the Engineer as communication facilities. Accessories shall include protective carrying case, AC charger and pre-paid cards at a nominal rate of PHP 1000 per month per cellular phone.

Failure on the part of the Contractor to provide such within the stipulated time shall allow the Engineer to take such action as he may be deemed necessary, and charge all relevant expenses to the Contractor by deducting the amount from the Contractor's monthly billing. This is specified in Item A.1.5(1) Provision of Communication Facility for the Engineer

A.1.6 Schedule of Facilities for the Engineer

A.1.1(11) Provision of Furniture/Fixtures, Equipment & Appliances for the Engineer's Field Office

A.1.1(13) Provision of Furniture/Fixtures, Equipment & Appliances for the Living Quarters of the Engineer

PART A	FACILITIES FOR THE ENGINEER		
Item No.	A.1.1(11)		
	Provision of Furnitures/ Fixtures, Equipment and Appliances for the Engineer’s Field Office		
	Description	Unit	Quantity
A	Furnitures, Equipment, Fixtures and Appliances		
1	Digital Camera	each	2
2	Working/Conference Table, with 10 chairs	set	2
3	Office Desk, 70 x 140 cm, (3 drawers on each side) with lock and keys	each	4
4	Office Desk, 60 x 105 cm, (3 drawers on each side) with lock and keys	each	4
5	Swivel Chair with padded seat and back arm rest, to match desk	each	8
6	Plan Rack	each	8
7	Steel Filing Cabinet, 4 Drawers with lock and keys, fire resistant	each	8
8	Scientific Calculator, Battery Operated, Casio Model or equivalent	each	8
9	Heavy Duty Combo Binder	each	4
10	Magnetic Whiteboard, 4ft x 8 ft.	each	2
11	Electric Stand Fan, 16” diameter	each	4
12	Fire Extinguisher, 10 lbs.	each	4
13	Hot and Cold Water Dispenser for drinking	each	2
14	Raincoats	set	20
15	Safety Shoes (Steel Toe)	pair	12
16	Hard Hat	each	20
17	Air conditioning Unit, Window Type, 2 Hp Remote	unit	3
18	Wall Clock	each	3
19	3 in 1 Inject Printer (Print, Scan, Copy)	unit	2
20	Desktop Computer, Intel Core TM2 Duo; Loaded complete with Microsoft Office	unit	4

PART A	FACILITIES FOR ENGINEER		
Item No.	A.1.1(13)		
	Provision of Furnitures/Fixtures, Equipment & Appliances for the Living Quarters of the Engineer		
Description		Unit	Quantity
A	Furniture, Equipment, Fixtures and Appliances		
1	Dining Table with 6 Chairs	set	2
2	Gas Stove Double Burner with Tank	set	2
3	Plate Cabinet	set	8
4	Single Bed with Foam	set	8
5	Hot and Cold Water Dispenser for drinking	each	2
6	Air conditioning Unit, Window Type, 1 Hp Remote	unit	2
7	Washing Machine 6.5kg	unit	2
8	Electric Stand Fan, 16" diameter	each	2
9	32" Flat TV, LED	each	2
10	Refrigerator, 6 cu.ft.	each	2
11	Electric Stand Fan, 16" diameter	each	6
12	Wall Clock	each	2

PART A	FACILITIES FOR ENGINEER		
	Minimum List of Contractor's Owned Laboratory Testing Equipment, Apparatus and Publications for the use of the Engineer (Optional)		
	Description	Unit	Quantity
I	<u>Mechanical Sieve Analysis of Soils and Analysis of Fine and Course Aggregates</u>		
	Sieve Analysis Set, 203 mm \varnothing x 51 mm depth, Brass, AASHTO M92		
1.	3" 8" \varnothing Brass Sieve	each	1
2.	2 1/2" 8" \varnothing Brass Sieve	each	1
3.	2" 8" \varnothing Brass Sieve	each	1
4.	1 1/2" 8" \varnothing Brass Sieve	each	1
5.	1" 8" \varnothing Brass Sieve	each	1
6.	3/4" 8" \varnothing Brass Sieve	each	1
7.	1/2" 8" \varnothing Brass Sieve	each	1
8.	3/8" 8" \varnothing Brass Sieve	each	1
9.	#4 8" \varnothing Brass Sieve	each	1
10.	#8 8" \varnothing Brass Sieve	each	1
11.	#10 8" \varnothing Brass Sieve	each	1
12.	#12 8" \varnothing Brass Sieve	each	1
13.	#16 8" \varnothing Brass Sieve	each	1
14.	#20 8" \varnothing Brass Sieve	each	1
15.	#30 8" \varnothing Brass Sieve	each	1
16.	#40 8" \varnothing Brass Sieve	each	1
17.	#50 8" \varnothing Brass Sieve	each	1
18.	#100 8" \varnothing Brass Sieve	each	1
19.	#200 8" \varnothing Brass Wash Sieve	each	1
20.	#200 8" \varnothing Brass Wash Sieve, 4" deep for washing	each	1
21.	Brass Pan, 8" \varnothing x 2" deep	each	1
22.	Brass Cover with ring	each	1
23.	Galvanized Steel Pan, 24" x 24" x 2"	each	1
24.	Galvanized Steel Pan, 24" x 24" x 4"	each	1
25.	Volumetric Flask, 500 ml with top	each	1
26.	Hand Operated Shaker for 8" \varnothing Sieve	each	1
27.	Mechanical Shaker	each	1
28.	Balance, sensitive to 0.50 gram, 20 kg. capacity set of weight to accommodate capacity of balance	unit	2
29.	Triple Beam Balance, 2610 grams per 0.10 gram	unit	2
30.	Volumetric Flask, 250 ml with top	each	1
II	<u>Atterberg Limits</u>		
31.	Liquid Limit Test	each	1
32.	Plastic Limit Test	each	1
33.	Balance, sensitive to 0.001 gram, 1.0 kg. capacity with set of weights	each	1
34.	Moisture Cans, 150 mm \varnothing	each	1
35.	Evaporating Disk	each	1
III	<u>Shrinkage Factor Test</u>		
36.	Shrinkage Limit Test	each	1
37.	Disk, for Mercury, 150 mm \varnothing	each	1
38.	Spatula	each	1

39.	Shrinkage Disk, 45 mm \emptyset	each	1
40.	Straight Edge, 300 mm	each	1
41.	Glass Container, 50 mm \emptyset	each	1
42.	Glass Plate, 2 mm x 80 mm x 80 mm	each	1
43.	Glass Plate with Prongs	each	1
44.	Graduated Cylinder, 25 ml.	each	1
45.	Mercury, 500 cc	bottle	1
IV	<u>Moisture Density</u>		
	Compaction Test		
46.	Compaction Mold, 4" \emptyset	each	1
47.	Compaction Rammer, 5.5 lbs.	each	1
48.	Compaction Mold, 6" \emptyset	each	1
49.	Compaction Rammer, 10 lbs.	each	1
50.	Sample Extruder	each	1
51.	Steel Straight Edge	each	1
52.	Mixing Pan, 24" x 24" x 3"	pc.	1
53.	Moisture Cans, 3 oz.	dozen	2
V.	<u>Specific Gravity Test</u>		
	Specific Gravity Test Set of Soil		
54.	Analytical Balance, 200 gms cap., sensitive to 0.0001 gm.	unit	1
55.	Pycnometer Top and Jar	pair	1
56.	Volumetric Flask, 500 ml.	each	1
57.	Thermometer, Range 0 -100°C graduated 1°C	each	1
	Fine Aggregates Specific Gravity Test Set		
58.	Balance, sensitive to 0.1 gram, 1.0 kg. capacity with set of weights	unit	1
59.	Volumetric Flask, 500 ml.	each	1
60.	Conical Mold, Metal	each	1
61.	Tamping Rod	each	1
	Coarse Aggregates Specific Gravity Test Set		
62.	L.A. Abrasion Machine Model	each	1
63.	Balance, sensitive to 0.5 gram, 5.0 kg. capacity with set of weights	unit	1
64.	Basket, Mesh Opening 3.35 or 2.86 mm \emptyset ht. = 20mm	each	1
65.	Steel Container for Wire Basket	each	1
66.	Steel Stand with Rubber Plate covering upper surface	each	1
VI	<u>Sand Equivalent Value</u>		
67.	Sand Equivalent Base Set compose of:	set	1
	Sand Reading Indicator		
	Irrigator Tube		
	Measuring Graduated Cylinder		
	Siphon Assembly		
	Measuring Tin 90ml., 60 mm \emptyset		
	Funnel		
	Bottle, 4-Liter Enamel Tray, 345 mm x 265 mm		

	60 mm		
68.	Sieve 4.75 (No.4)	set	1
69.	Anhydrous, Calcium Chloride, 500 grams	each	1
70.	Glycerin	each	1
71.	Formaldehyde	each	1
VII	<u>California Bearing Ratio (CBR)</u>		
72.	Mechanical CBR Loading Apparatus with Strain Gauge proving ring and penetration piston	set	1
73.	CBR mold, 6" x 7" with perforated base plate and collar	each	6
74.	Spacer Disk	each	1
75.	Filter Screen	each	12
76.	Swell Plate	each	6
77.	Dial Gauge	each	1
78.	Tripod Attachment	each	3
79.	Slotted Surcharge Weights	each	6
80.	Circular Surcharge Weights	each	6
81.	Cutting Edge	each	1
VIII	<u>Density of Soil in-Place by Sand Cone Method</u>		
82.	Sand Density Apparatus	each	1
83.	Sand Cone and Jug	each	2
84.	Density Plate	each	1
85.	Replacement Jug	each	2
86.	Sampling Spoon	each	1
87.	One Gallon Field Cans	each	2
88.	Once Inch Steel Chisel	each	1
89.	Sand Scoop	each	1
90.	Ball Hammer	each	1
91.	Field Scale, 16 kg., 20 grams sensitivity	unit	1
92.	Spoon Sampling	each	1
IX	<u>Specific Gravity and Absorption Test</u>		
93.	Sand Absorption Cone and Tamper	each	1
94.	Tribble Beam Balance, 2610 grams/0.10 gram	unit	1
95.	Micro Poise Balance, 100 grams/0.10 gram	unit	1
96.	Density Basket	each	1
97.	Bucket for immersing aggregates	each	1
98.	Pycnometer Top and Jar	pair	1
99.	Volumetric Flask, 250 ml	each	1
100.	Volumetric Flask, 500 ml	each	1
101.	Tin Pans, Rectangular, 4" x 4" x 16"	each	1
X	<u>Compression Strength of Molded Concrete Cylinder</u>		
102.	Compression Machine, Hydraulic Operated with changeable head for flexural testing	set	1
103.	Air Entrapment Meter	each	1
104.	Capping set for Capping of Specimen	set	1
105.	Capping Compound	bag	8

XI	<u>Making and Curing Concrete Compression and Flexural Test Specimen in the Field</u>		
106.	Molds for Compression Test Specimen	each	1
107.	Molds for Flexural Test Specimen	each	1
108.	Tamping Rod, 5/8" ø, 24' long having one end hemispherical	each	1
109.	Small Tools	set	1
	Two (2) each of shovels, pail trowel wood float, blunted trowels, straight edge, feeler gauge, scoops, rubber mallet and rulers		
XII	<u>Concrete Coring and Saw Cutting</u>		
110.	Core Drill Machine with 150 mm ø with two drill bits	set	1
111.	4" ø, drill bit for concrete cored sample	each	2
112.	Concrete Saw Cutter	set	1
XIII	<u>Slump of Portland Cement Concrete</u>		
113.	Slump Test Apparatus: Slump Cone with Base and Graduated Tamping Rod	set	1
114.	Mixing Pan, 24" x 24" x 3"	each	1
115.	Cement Towel	each	1
116.	Armoured Thermometer	each	1
117.	Yield Bucket, 1/10 cu. ft.	each	1
118.	Yield Bucket, ½ cu. ft.	each	1
XIV	<u>Miscellaneous Equipment</u>		
119.	Laboratory Oven, Double Wall Gravity connection 220V/60 cy., A.C. Cap. 1 cu.m.	set	1
120.	Hot Plate, 12" x 12", 220 V	each	1
121.	Speedy Moisture Tester	each	1
122.	Organic Impurities Test Set	set	1
123.	Sand Equivalent Test Set	each	1
124.	Gas Range, 2 – Burners	each	1
XIV	<u>Miscellaneous Equipment</u>		
125.	Sodium Hydroxide Solution	bottle	1
126.	Capping Compound, 55 lbs.	bag	1
127.	Sodium Sulfate	bottle	1
128.	Calcium Carbide Reagent	bottle	1
129.	Sand Equipment Solution Standards	bottle	1

A.2 MEASUREMENT AND PAYMENT

A.2.1 Measurement

1. Lump sum items shall be provided for the following:

- a) Provision of one (1) Unit Field Office Building with all its land development. Land development includes the raising of the grades (as maybe required by the Engineer), the perimeter fencing to a desired height as approved by the Engineer and the

provision of access walkways, sodding or seeding of the ground around the building and provision of access roads to parking areas. Payment shall be made on a lump sum basis or on a pro-rata basis of the contract unit price as reflected in the Bill of Quantities or as directed by the Engineer.

- b) Provision for furnishing and transporting of Furniture/Fixtures, Equipment and Appliances for the Field Office and Living Quarters of the Engineer.
 - c) Provisions for furnishing Communication Equipment for the Engineer.
2. Provision of two (2) Units of Living Quarters for the Engineer will be paid for from the time the Engineer occupies the facilities. Payment shall be made on a monthly rental basis at the contract unit price shown in the Bill of Quantities.
 3. Operation and Maintenance of the Field Office and Living Quarters for the Engineer will be paid for from the time the Engineer occupies the facilities until the final completion of the Work. Payment shall be made on a monthly basis at the contract unit price shown in the Bill of Quantities.
 4. Provision for furnishing supplies and consumables stores for the Engineer's field office and communication equipment shall be paid upon the provision and supplied is accepted by the Engineer. Payment shall be made on a monthly basis at the contract unit price shown in the Bill of Quantities.
 5. Provision of rented vehicles for the Engineer as specified will be paid for during the time when the Engineer is supplied with each type of vehicles until the completion of the project. The unit of measurement to be paid shall be per vehicle per month.
 6. Operation and Maintenance of Vehicles for the Engineer as specified for shall be paid for during the time which the Engineer is supplied with each type of vehicles which shall be supplied with appropriate fuel and lubricants. Servicing and maintenance requirements included and regular cleaning inside and out with the provision of some necessary replacement parts from time to time. The salary of the respective drivers shall be under this item. This operation and maintenance will be from the start of the Engineer had accepted the said vehicle until the completion of the project. The unit of measurement to be paid for shall be per vehicle per month.
 7. Provision of Survey Personnel as assistance to the Engineer shall be paid for from the time the Engineer is supplied with the survey personnel until the final completion of the Contract. Payment shall be made on a monthly basis for the survey personnel, while the supply and provision of survey instruments is deemed to be Contractor's owned and shall not be subject for payment.
 8. The quantities for Progress Photographs shall be measured as per monthly basis with the number of photographs taken, selected and provided as progress photographs. The unit of measure is each at the contract unit price shown in the Bill of Quantities.

9. Provision of the communication facility for the Engineer shall be paid from the time the unit had been received and approved by the Engineer. Monthly pre-paid call cards for each unit are included in this Item and payment shall be for each unit provided at the contract unit price shown in the Bill of Quantities. The unit measure is “each”.

A.2.2 Payment

Payment will be made under:

Pay Item Number	Description	Unit of Measurement
A.1.1(3)	Provision of Field Office Building for the Engineer	Lump Sum
A.1.1(10)	Provision of Living Quarter for the Engineer, 2 Units- (Rental Basis)	Month
A.1.1(11)	Provision of Furnitures/Fixtures, Equipment and Appliances for Field Office for the Engineer	Lump Sum
A.1.1(13)	Provision of Furnitures/Fixtures, Equipment and Appliances for the Living Quarters for the Engineer	Lump Sum
A.1.1(16)	Operation and Maintainance of Field Office for the Engineer	Month
A.1.1(18)	Operation and Maintainance of Living Quarters for the Engineer	Month
A.1.2(2)	Provision of 3 Units, 4x4 Pick-Up Type, Service Vehicle for the Engineer (Rental Basis)	Month
A.1.2(5)	Operation and Maintenance of 3 Units, 4x4 Pick-Up Type, Service Vehicle for the Engineer	Month
A.1.3(3)	Provision of Survey Personnel for the Assistance to the Engineer	Month
A.1.4(1)	Provision of Progress Photographs	Month
A.1.5(1)	Provision of Communication Facility for the Engineer	Each

PART B

OTHER GENERAL REQUIREMENTS

PART B- OTHER GENERAL REQUIREMENTS**B.1 OFFICES, SHOPS, STORES AND WORKMEN'S ACCOMMODATION FOR CONTRACTOR**

The Contractor shall provide and maintain their field offices, stores, workshops latrines, housing and accommodations as are necessary. These shall be located in the Contractor's compound, distinct and separate from the Engineer's compound. The location, dimensions and layout of such buildings and places shall be subject to the approval of the Engineer.

The selection of the site shall be the responsibility of the Contractor and shall be approved by the Engineer. It is entirely up to the Contractor to make whatever arrangements he deems necessary with the landowners regarding the use of land for the purpose of erecting camps, workshops, garages, stockpiling of materials, locations of plant, housing of laborers and staff, welfare facilities, etc. All costs incurred in connection with the rental or lease of such land shall be at the Contractor's expense.

The Contractor shall be solely responsible for the erection, maintenance and subsequent disposal of whatever facilities he deems necessary to execute the Works. The Contractor shall not be permitted to erect temporary buildings or structures within the road right-of-way without prior written approval from the Engineer.

B.2 MEDICAL ROOM AND FIRST AID FACILITIES

The Contractor shall provide and maintain throughout the duration of the project, a medical room together with all necessary supplies to be sited in the Contractor's main area. The medical room shall be waterproof; it could be a building or a room designated and used exclusively for the purpose. It shall have a floor area of at least 15 square meters and a glazed window area of at least 2 square meters.

The Contractor shall employ permanently on the site a fully trained Medical Aide, who shall be engaged solely on medical duties.

The location of such room and any other arrangements shall be made known to all employees by posting a notice on prominent locations suitable in the Site.

The Contractor's arrangement to comply with this Section shall be subject to the approval of the Engineer and also the approval of any qualified Medical Officer designated by the Government to supervise medical arrangements on the Site.

Payment and price is in Lump Sum basis and shall constitute full compensation for the compliance and provision of all the necessary first aid room and facilities with all the furniture and supplies as listed in the Schedule below. This item also includes the salary of the medical staff assigned solely for the project.

Pay Item Number	Description	Unit of Measurement
B.2	Medical Room and First Aid Facilities	Lump Sum

B.2.1 Schedule of Other Requirements for Medical Room and First Aid Facilities

PART B.2	MEDICAL ROOM AND FIRST AID FACILITIES		
Description		Unit	Quantity
A	Requirements for Medical Room and First Aid Facilities		
1	Wash Basin (hand) with hot water and cold water	each	1
2	Bed	each	1
3	Chairs	each	4
4	Office Table,	each	1
5	Electric Kettle or Equivalent	each	1
6	Complete First Aid outfit	set	1
7	Bed Sheets, cotton, 150cm x 200cm	each	2
8	Pairs of Polyester Pillow, 30cm x 60cm x 15 cm	pair	1
9	Pillow Case, 40cm x 80cm.	each	2
10	Blanket Cotton, 160cm x 200cm.	each	2
11	Fire Extinguisher, 10 lbs.	each	2
12	Fire Extinguisher, Refill	each	2

B.3 QUALITY CONTROL OF MATERIALS

All Quality Control Procedures should be in accordance with the DPWH Bureau of Research and Standard Requirements and the Contractor’s Approved Quality Control/Quality Assurance Procedures. All Quality Control Tests will be done with the Accredited Material Testing Laboratories or Material Testing Centers approved by the Engineer.

B.3.1 Source of Supply and Quality of Materials

Promptly after receiving the contract award, the Contractor shall notify the Engineer of all proposed material sources, including fabricators of steel or other finished products. Prior to delivery of materials, sources shall be approved first by the Engineer. If proposed material sources are not acceptable by the Engineer, the Contractor shall locate other sources and obtain approval from the Engineer.

All equipments, materials, and articles incorporated into the permanent work shall:

- 1) Be new, unless the Specifications permit otherwise;
- 2) Meet the requirements of the Contract and be approved by the Engineer;
- 3) Be inspected or tested at any time during their preparation and use; and

- 4) Not be used in the work if they become unfit after being previously approved.

B.3.2 Samples and Tests for Acceptance

The Contractor shall deliver material samples from the Manufacturer, Producer, or Fabricator to the Engineer prior to execution of work. In providing samples, the Contractor shall provide the Engineer with sufficient time and quantities for approval before use. The Engineer may require samples at any time. Samples not taken in the presence of the Engineer will not be accepted for testing, unless the Engineer permits otherwise.

The Contractor shall designate his experienced personnel as direct contact person for material testing and acceptance. In his absence, the Contractor shall designate other personnel of the same experience to ensure that direct contact is maintained during the execution of work.

The Engineer will designate also an experienced representative as point of contact for material testing and acceptance.

All field and laboratory material tests to be undertaken by the Contractor shall be in accordance with the methods described in the contract documents, or in the recognized standards of national organizations. The following provisions will apply when the Contractor uses the specifications or methods from the sources named hereunder:

ASTM – American Society for Testing and Materials: The ASTM designation number refers to the society's latest adopted or tentative standard. The standard or tentative standard in effect on the bid advertising date, will apply in each case.

Copies of any separate ASTM specifications or testing method may be obtained from: the American Society for Testing and Materials, 1916 Race Street, Philadelphia, USA.

AASHTO – American Association of State Highway and Transportation Officials: An AASHTO number refers to that organization's currently published (1) "Standard Specifications for Transportation Materials and Methods of Sampling and Testing" or any adopted revisions, or (2) "Interim Specifications and Methods of Sampling and Testing adopted by the AASHTO Subcommittee on Materials."

Any standards, revisions, and interim standards in effect on the bid advertising date will apply.

Copies of "Standard Specifications for Transportation Materials and Methods of Sampling and Testing" may be obtained from the American Association of State Highway and Transportation Officials, 917 National Press Building, Washington, DC, USA.

JIS - Japan Industry Standard: The JIS designation number refers to the latest adopted or tentative standard. The standard or tentative standard in effect on the bid advertising date, will apply in each case.

JRA - Japan Road Association: All references to JRA Specifications refer to the latest adopted or tentative specification. The specification or tentative specification in effect on the bid advertising date, will apply in each case.

B.3.3 Removed and Rejected Materials

The Contractor may, prior to sampling, select to remove any defective material(s) and replace it with new material(s) at no expense to the Employer. Any such new material will be sampled, tested and evaluated for acceptance as a sub-lot in accordance with the sampling and testing procedure.

The Engineer may reject a sub-lot wherein tests show to be defective. Such rejected material shall be removed from the site and the results or test run on the rejected material will not be included in the original lot acceptance tests.

B.3.4 Manufacturer's Certificate of Compliance

The Engineer may accept certain materials on the basis of a Manufacturer's Certificate of Compliance as an alternative to material inspection and testing. When a Manufacturer's Certificate of Compliance is authorized by these Specifications, the certificate shall be furnished to the Engineer for approval prior to the use of material.

The Contractor may request, in writing, authority from the Engineer to install such material prior to submitting the required certification; however, no payment shall be made for the work in the absence of the acceptable Manufacturer's Certificate of Compliance. The Employer reserves the right to deny the request for good cause.

If for any reason, the Contractor has no acceptable Manufacturer's Certificate of Compliance on the completion date of the work, the Employer may process the final payment without paying for the work performed on such basis.

The Manufacturer's Certificate of Compliance must identify the manufacturer, the type and quantity of material being certified, the applicable specifications being affirmed, and the signature of a responsible corporate official of the manufacturer and include supporting mill tests or documents. A Manufacturer's Certificate of Compliance shall be furnished with each lot of material delivered to the site and the lot so certified shall be clearly identified in the certificate.

All materials used and identified in the Manufacturer's Certificate of Compliance may be sampled and tested at any time. Any material not conforming to the requirements will be subject to rejection whether in place or not. The Employer reserves the right to refuse to accept materials not on the basis of a Manufacturer's Certificate of Compliance.

B.3.5 Handling and Storing Materials

In storing and handling materials, the Contractor shall protect any materials against damage from careless handling, from exposure to weather, from mixture with foreign matter, and from all other causes.

The Engineer will reject and refuse to test materials improperly handled or stored.

B.3.6 Sieves for Testing

Test sieves shall be made either: (1) of woven wire cloth conforming to AASHTO Designation M 92 or ASTM Designation E 11, or (2) of square-hole, perforated plates conforming to ASTM Designation E 323.

B.3.7 Compliance to Test Requirements

All tests and quality control works shall be done by the Contractor's Accredited Materials Testing Centers and Laboratory Staff under the direct supervision of the Engineer.

All tests shall normally be carried out on the site, and that certain special test may, subject to the approval of the Engineer, be carried out at *an approved and accredited independent testing laboratory*. The Contractor shall make all the necessary arrangements for the supply and delivery of samples to, and collection of samples from such independent laboratory. Unless otherwise directed by the Engineer, the Contractor shall arrange for one copy of the independent testing laboratory test certificates to be delivered to the Engineer not less than three (3) days before the materials covered by the relevant test certificate are incorporated into the works, and the test certificate shall be related to the materials from which the samples were taken. These test and quality control works shall be the responsibility of the Contractor.

The Contractor shall comply with the Minimum Materials Testing Equipment Requirement given in, Appendix 4 to Bid, Volume 1 of the Bidding Documents

When requested, the Contractor shall furnish a complete written statement of the origin, composition and/or manufacture of any or all materials (manufactured, produced or grown) that are to be used in the works.

Unless otherwise provided, sampling and testing of materials shall be made by the Contractor, under the direct supervision of the Engineer in accordance with the methods given in the "Standard Specifications for Highway Materials and Methods of Sampling and Testing" of the latest edition of AASHTO.

1. Soils and Aggregates

T-11	Amount of Materials Finer than 0.75mm sieve in Aggregate
T-88	Particle Size Analysis of Soils
T-89	Determining the Liquid Limit of Soils
T-90	Determining the Plastic Limit and Plasticity Index of Soils
T-99	Moisture Density Relations of Soils Using a 2.5 kg Rammer and 305 mm Drop
T-100	Specific Gravity of Soils
T-180	Moisture Density Relations of Soils Using a 4.54 kg Rammer and a 457 mm Drop
T-191	Density of Soils In-Place by the Sand Cone Method

T-193	The California Bearing Ratio of Laboratory Compacted Soils (CBR)
T-84	Specific Gravity and Absorption of Fine Aggregate
T-85	Specific Gravity and Absorption of Coarse Aggregate
T-19	Unit Weight of Aggregate
T-27	Sieve Analysis of Fine and Coarse Aggregates
T-96	Resistance to Abrasion by use of Los Angeles machine

2. Concrete

T-21	Organic Impurities of Sands for Concrete
T-22	Compressive Strength of Molded Concrete Cylinder
T-23	Making and Curing Concrete Compressive and Flexural Strength Test Specimens in the Field
T-24	Obtaining and Testing Drilled Cores and Sawed Beams of Concrete
T-97	Flexural Strength of Concrete
T-119	Slump of Portland Cement Concrete
T-126	Making and Curing of Concrete Test Specimens in the Laboratory
T-141	Sampling of Fresh Concrete
T-148	Measuring Length of Drilled Concrete Cores
T-231	Capping Cylinder Concrete Specimen

3. Bituminous Materials

T- 40	Sampling Bituminous Materials
T- 49	Penetration of Bituminous Materials

4. Publications

The Contractor shall provide two (2) copies each of the latest edition of the following publications:

- Part I, American Association of State Highway and Transportation Officials – Specifications
- Part II, American Association of Stage Highway and Transportation Officials – Tests
- Japan Road Association(JRA) Standard Specifications for Highway Bridges, Parts 1,2,3, 4 and 5 (in English if available)
- JIS Standard for Paints, Screw Threads, Quality Control, Welding, Ferrous Materials and Metallurgy, Piping and other JIS standards as may be requested by the Engineer.

These publications may be stored visibly in the office of the Engineer for future reference.

B.4 CONSTRUCTION SURVEY AND STAKING

B.4.1 Description

The Contractor shall provide all necessary equipment, materials, skilled and experienced engineering personnel to execute both survey, stake, field works, calculate and record data for the control of work in accordance with this Specification and conforming to the instruction given to him by the Engineer. Quality performance of work and strict conformity to the lines, grades and dimensions shown on the Plans or

as established or required by the Engineer shall be observed in the field. Field survey work to be performed by the Contractor shall include but not necessarily limited to the following:

- 1) Setting-out / Staking-out of the Works; and
- 2) Measurements of the Works for pay quantities.

In addition to the above routine field survey services, the Contractor shall assign a geo-technical engineering specialist to monitor and ensure compliance with additional soil borings, if ordered by the Engineer.

B.4.2 Setting-Out/Staking-Out of the Work

The Contractor shall have sole responsibility of establishing and maintaining all horizontal and vertical control points required or as may be directed by the Engineer. Information for the existing control monuments is shown on the Drawings and shall be used by the Contractor for establishing the horizontal and vertical controls needed for his work.

Staking activities shall be included in the construction schedule to be submitted by the Contractor to the Engineer. Dates and sequence of each staking activity shall be included.

Schedule and notification to survey shall be provided to the Engineer and be subject for review and monitoring by the Engineer's representative.

The Engineer shall set initial reference lines, horizontal and vertical control points, and shall furnish the data for use in establishing control for the completion of each element of the work. Data relating to horizontal and vertical alignments, theoretical slope stake catch points, and other design data shall be furnished.

The Contractor shall be responsible for the true setting of the works or improvements and for correctness of positions, levels, dimensions and alignment of all parts of the works. He shall provide all necessary instruments, appliances, materials and supplies, and labor in connection therewith. The Contractor shall provide a survey crew supervisor at the project site whenever surveying/staking activity is in progress.

The Contractor shall make minor adjustments subject to the Engineer's approval in the event that discrepancies are found between the information shown on the Drawings and the actual field conditions.

From the control points provided by the Engineer, the Contractor shall establish all additional and intermediate controls for accurately locating all structures, centerlines, right-of-way limits, slopes, etc. as shown on the Drawings and required by the Contract.

Prior to construction, the Engineer shall be notified of any missing initial reference lines, control points, or stakes. The Engineer shall reestablish missing initial reference lines, controls, points, or stakes.

The Contractor, for convenient use of Government-furnished data shall

perform additional calculations. Immediate notification of apparent errors in the initial staking or in the furnished data shall be provided.

All initial reference and control points shall be preserved. At the start of the construction, all destroyed or disturbed initial reference or control points necessary to the work shall be replaced.

Before surveying and staking, the Contractor shall discuss and coordinate the following with the Engineer:

1. Surveying and staking method
2. Stake marking/concrete monuments
3. Grade control for courses of material
4. Referencing
5. Structure control
6. Any other procedures and controls necessary for the work

The Contractor shall prepare field notes in an approved format. All field notes and supporting documentation shall become the property of the government upon completion of the work.

Work shall only be started after staking for the affected work is accepted.

The Construction survey and staking work may be spot-checked by the Engineer for accuracy, and unacceptable portions of work may be rejected. Rejected work shall be resurveyed, and work that is not within the tolerances shall be corrected. Acceptance of the construction staking shall not relieve the Contractor of responsibility for correcting errors discovered during the work and for bearing all additional costs associated with the error, unless such error is based on incorrect data supplied in writing by the Engineer, in which case, the expense in rectifying the same shall be at the expense of the Government.

In the case of "change" or "changed conditions" which involve any change in stakeout, the Contractor shall coordinate with the Engineer and facilitate the prompt reestablishment of the field control for the altered or adjusted work.

All flagging, lath, stakes, and other staking materials shall be removed and disposed after the project is completed.

B.4.2.1 Equipment

Survey equipments and supporting equipment capable of achieving the specified tolerances shall be furnished.

Acceptable tools, supplies, and stakes of the type and quality normally used in the highway survey work and suitable for the intended use shall be furnished. Stakes and hubs of sufficient length to provide a solid set in the ground with surface area above ground for necessary legible markings shall also be furnished.

B.4.2.2 Survey and Staking Requirements

All survey, staking, recording of data, and calculations necessary to

construct the project from the initial layout to the final completion shall be performed. Stakes shall be reset as many times as necessary to construct the work.

1. Control Points

Established initial horizontal and vertical control points in conflict with the construction shall be relocated to areas that will not be disturbed by construction operations. The coordinates and elevations for the relocated points shall be furnished before the initial points are disturbed

2. Roadway Cross-Sections

Roadway cross-sections shall be taken normal or perpendicular to the centerline. When the centerline horizontal curve radius is less than or equal to 150 meters and vertical parabolic curve radius is less than or equal to 100 meters, cross-sections shall be taken at a maximum centerline spacing of 10 meters.

When the centerline horizontal curve radius is greater than 150 meters and vertical parabolic curve radius is greater than 100 meters, cross-sections shall be taken at a maximum centerline spacing of 20 meters.

Additional cross-sections shall be taken at significant breaks in topography and at changes in the typical roadway sections including transition change to superelevated sections. Points shall be measured and recorded to at least the anticipated slope stake and reference locations. All cross-section distances shall be reduced to horizontal distances from centerline.

3. Slope Stakes and References

Slope stakes and references shall be set on both sides of centerline at the cross-section locations. Slope stakes shall be established in the field as the actual point of intersection of the design roadway slope with the natural ground line. Slope stake references shall be set outside the clearing limits.

All reference point and slope stake information shall be included on the reference stakes. When initial references are provided, slope stakes may be set from these points with verification of the slope stake location with field measurements.

4. Clearing and Grubbing Limits

Clearing and grubbing limits shall be set on both sides of centerline at roadway cross-section locations, extending one (1) meter beyond the toe of the fill slopes or beyond the rounding of cut slopes as the case maybe for the entire length of the project unless otherwise shown on the plans or as directed by the Engineer.

B.4.3 Centerline Reestablishment

The centerline shall be reestablished from instrument control points. The maximum spacing between centerline points shall be 10 meters when the centerline horizontal curve radius is less than or equal to 150meter and the vertical parabolic curve radius is less than or equal to 100 meters. Then the centerline horizontal curve radius is greater than 150meters and the vertical parabolic curve radius is greater than 100meters, the maximum distance between centerline points shall be 20 meters.

B.4.4 Culvert Survey and Staking

Culverts shall be staked to fit field conditions. The locations of culverts may differ from the plans. The following shall be performed:

- a) Survey and record the ground profile along the culvert centerline including inlet and outlet channel profile of at least 10 meters and as additionally directed by the Engineer so as to gather all necessary data for the preparation of pipe projection plan.
- b) Determine the slope catch points at the inlet and outlet.
- c) Set the reference points and record information necessary to determine culvert length and end treatments.
- d) Plot into scale the profile along the culvert centerline reflecting the natural ground elevation, invert elevation, the flow line, the roadway section, and the size, the length of the degree of elbow of culvert, and treatments, grade and other appurtenances.
- e) Plot into scale the cross-section of the inlet and outlet channel at not more than 5 meters interval.
- f) Submit the plotted Pipe Projection Plan for the approval of final culvert length, alignment and headwall.
- g) When the Pipe Projection Plan has been approved, set drainage culvert structure survey and reference stakes, and stakes inlet and outlet to make the structure functional.

B.4.5 Bridge Survey and Staking

Adequate horizontal and vertical control and reference points shall be set for all bridge structure and superstructure components. The bridge chord or the bridge tangent shall be established and referenced. The centerline of each pier, bent, and abutment shall also be established and referenced.

Set at least three (3) reference points each at downstream and upstream portion. Conduct topographic survey and plot into scale at least 100 meters upstream and downstream from the centerline of bridge.

B.4.6 Retaining Walls and Other Types of Slope Protection Works Survey and Staking

Profile measurements along the face of the proposed wall and 2 meters in front of the wall face shall be surveyed and recorded. Cross-sections shall be taken within the limits designated by the Engineer at every 5 meters along the length of the wall and all major breaks in terrain. For each cross-section, points shall be measured and recorded every 5 meters and all major breaks in terrain. Adequate references and horizontal and vertical control points shall be set.

B.4.7 Grade Finishing Stakes

Grade finishing stakes shall be set for grade elevations and horizontal alignment, at the centerline and at each shoulder of the roadway cross-section locations. Stakes shall be set at the top of subgrade and the top of each aggregate course.

Where turnouts are constructed, stakes shall be set at the centerline, at each normal shoulder, and at the shoulder of the turnout. In parking areas, hubs shall be set at the center and along the edges of the parking area. Stakes shall be set at all ditches to be paved.

The maximum longitudinal spacing between stakes shall be 10 meters when the centerline horizontal curve radius is less than or equal to 150 meters and vertical parabolic curve radius is less than or equal to 100 meters. When the centerline horizontal curve radius is greater than 150 meters and vertical parabolic curve radius is greater than 100 meters, the maximum transverse spacing between stakes shall be 5 meters. Brushes or guard stakes shall be used at each stake.

B.4.8 Permanent Monuments and Markers

All survey and staking necessary to establish permanent monuments and markers shall be performed.

B.4.9 Miscellaneous Survey and Staking

All surveying, staking, and recording of data essential for establishing the layout and control of the following shall be performed, as applicable:

- a. Approach roads and trails
- b. Road Right of way and Construction limit in accordance with the approved Parcellary Plan.
- c. Curb and gutter
- d. Guardrail
- e. Parking Areas
- f. Paved waterways and outfall structures
- g. Lined canals and other ditches
- h. Chutes and Spillways
- i. Turf establishment
- j. Utilities

- k. Signs, delineators, and object markers
- l. Pavement markings

B.4.10 Method of Measurement and Payment

The Contractor and Engineer shall jointly measure the Works for the purpose of establishing progress and final pay quantities. Construction survey and staking shall be measured by the kilometer.

Bridge survey and staking, and retaining wall survey and staking shall be measured by the lump sum.

Slope, reference and clearing and grubbing stakes shall be measured by the kilometer.

Culvert survey and staking shall be measured by the each.

Grade finishing stakes shall be measured by the kilometer. Subgrade shall be measured one tie and each aggregate course shall also be measured one time.

Permanent monuments and markers shall be measured by each unit placed and installed at the proper locations.

The Contractor shall provide all necessary personnel and equipment to perform the measurements for payment required by the Contract. Such measurements and quantity calculations will not be accepted unless conducted jointly with and monitored by the Engineer.

Whenever required for the purposes of measurement of quantities, the Contractor shall take cross sections on the original ground at intervals of 20 meter or less, as directed by the Engineer. The profiles so established shall be plotted on tracing paper to a scale, size and layout as stipulated by the Engineer or encoded in a CAD system to the approval on the Engineer. The drawn cross sections shall include the proposed finished lines derived from the approved design details.

The original profile together with the three copies shall be submitted to the Engineer who will endorse one copy with his approval, or his revision thereof, and return it to the Contractor.

At any locations, measurement for pay quantities shall require material volumes to determine the difference between the after-construction (or design) profile and the existing before-construction profile. The Contractor shall carry out as part of his routine survey works all the necessary topographic surveys in sufficient detail to enable the work volumes to be accurately calculated.

The Contractor in his routine survey work for quantity measurement is required not only to make geometric measurement using precise levels, theodolites, chains, etc. but also is required to take and measure pavement cores as required by the Engineer. The Contractor is also required to check the embankment thickness by auger boring or settlement plates.

The Contractor shall also keep the haulage truck tallies and all other

methods of work volume measurement as the Engineer may direct. The detailed requirements for the measurement of the Works are specified for each Pay Item in the relevant sections of these Technical Specifications.

Payment will be made under:

Pay Item Number	Description	Unit of Measurement
B.4 (1)	Construction Survey and Staking	Kilometer
B.4 (2)	Slope, Reference, with Clearing and Grubbing Stakes	Kilometer
B.4 (3)	Centerline Reestablishment	Kilometer
B.4 (4)	Culvert Survey and Staking	Each
B.4 (5)	Bridge Survey and Staking	Lump Sum
B.4 (7)	Grade Finishing Stakes	Kilometer
B.4 (8)	Permanent Monuments and Markers	Each

B.5 PROJECT SIGN BOARD

Unless otherwise specified in other pay items of the Contract, the Contractor shall provide and erect project signboard at the exact location approved by the Engineer. The design, layout and wordings are all to be approved by the Engineer. All signboards shall display the title of the project, the name of the Employer, the funding agency and the consulting engineering company, and the funding Loan Agreement Reference Number. The signboard shall be maintained in good condition throughout the duration of the Contract, and shall be removed upon completion of the project to the satisfaction of the Engineer.

The quantities of Project Sign Board to be paid for shall be the number of project sign boards of size installed in place and accepted and shall be paid at the contract unit price indicated in the Bill of Quantities. Payment and price shall constitute full compensation for furnishing and installing all materials, all labor, equipment, tools and other incidental necessary to complete the Item.

Payment will be made under:

Pay Item Number	Description	Unit of Measurement
B.5	Project Sign Board	Each

B.6 TRANSPORTATION AND HANDLING

B.6.1 Standards

Work processes shall be conducted in strict conformity with the National, Provincial and Municipal regulations governing the work as

well as requirements for the preservation of natural resources and the environment.

B.6.2 Coordination with Others

The Contractor's attention is directed to the fact that he will be required to coordinate his transport operations with the work being performed or to be performed on other Contracts, with work of the subcontractors, utility companies and others as may be required.

In case of interference in operations from different Contractors, the Engineer shall have the sole power to direct each Contractor and to determine the sequence of work necessary to expedite the completion of the entire project, and in all cases his decision shall be accepted as final and shall not be caused for a claim.

B.6.3 Weight Limitations and Legal Requirements

If required, the Engineer may impose weight restrictions for the protection of any existing road or structure within the vicinity of the project. The Contractor is responsible in complying all legal weight restrictions of existing roads and highways used for his work. The Contractor shall provide portable scales as may be required to ensure compliance. The Contractor shall be responsible for any damage to roads or structures resulting from his construction operations.

B.6.4 Haul Roads

The Contractor shall, at his own expense, construct access and haul roads necessary for proper execution of the work under this contract. Haul roads shall be constructed with suitable grades and widths; sharp curves, blind corners, and dangerous cross traffic shall be avoided.

The Contractor shall provide necessary lighting, signs, barricades, and distinctive markings for the safe movement of traffic. The method of dust control shall be in accordance with the special clause "Dust Control". Location, grade, width, and alignment of construction and hauling roads shall be subject to the approval of the Engineer. Lighting shall be adequate to assure full and clear visibility for full width of haul road and work areas during any night work operations. Upon completion of the work, haul roads designated by the Engineer shall be removed.

B.6.5 Use of Existing Roads as Haul Routes

The Contractor shall be responsible for coordinating with the BCDA Authorities for the use of any existing roads as haul routes. Construction and routing of new haul roads, and/or upgrading of existing roads to carry the anticipated construction traffic shall be coordinated with the BCDA authorities and is the sole responsibility of the Contractor.

In case the hauling operations of the Contractor will cause damage to a public road or structure, or will cause flooding that will result to work stoppage of the operation, the Engineer may direct the Contractor to use an alternative route and the Contractor shall have no right to any

claims for any additional compensation to incurred damages during hauling operations.

B.6A PROVISIONS FOR PASSAGE OF TRAFFIC

The Contractor shall construct and maintain detours wherever the work will interfere with traffic on existing roads, footways or other ways over which there is a public or private right-of-way, until such time as permanent diversions to serve such traffic shall have been completed. No detours shall be constructed and no traffic diverted until the Contractor's proposals therefore have been approved by the Engineer and by the appropriate government authorities. Prior to the commencement of the construction and of the use of detours, the Contractor shall provide the Engineer with a full photographic record of the existing roads, pathways, etc. as directed by the Engineer and shall have the necessary temporary road signs ready for use.

No work which will inconvenience the traveling public shall be started until adequate provision satisfactory to the Engineer, shall have been made to divert the traffic in safety and in comfort. No road shall be closed to the public except by permission in writing from the Engineer and from the appropriate government authorities. Where traffic conditions permit, one-way-lane may be permitted by the Engineer. Material stored upon the roadway shall be so well placed and the work shall be so conducted as to cause as little obstruction as possible to the traveling public.

All detours shall be maintained in good condition at all times and shall have a total width of at least 6 meters and provided with graveled surface having a minimum compacted thickness of 80 mm. Where existing public or private roads are used as detours, the same shall be maintained in good riding condition at all times and just before completion of the Contract, such roads shall be restored to a condition not less satisfactory than that existing prior to the commencement of the work.

Where part-width construction is adopted, the part-width not under construction shall be made available to public traffic under alternate one-way control.

In such case, the Contractor shall furnish flagmen, pilot car and drivers to direct traffic through the section of road under one-way control. The length of part-width construction shall not exceed 500 meters for each section and the distance between successive sections of part-width construction shall not be less than 500 meters.

The Contractor shall so conduct his operations as to offer the least possible obstruction, inconvenience and delay to traffic and shall be responsible for adequate traffic control to achieve such an end.

Suitable warning signs, illuminated at night by electric bulbs, lanterns or flares shall be provided to mark the places not yet available to traffic. In part-width construction, the Contractor shall place acceptable barricades along the inside edge of the available surface so that traffic will be confined therein while the other part-width is under construction. One-way control shall continue until the adjoining surface is completed and opened to traffic.

At sections where part-width traffic is in operation, and when so ordered by the Engineer, the movements of the Contractor's equipment from one place of work to another shall be subject to such part-width traffic control. Spillage resulting

from hauling operations along or across the roadway shall be removed immediately at the Contractor's expense. For further details in connection with this Item see *Item B.8 - Traffic Management* during Construction provided hereinafter.

B.6B DISPOSAL OF MATERIALS OUTSIDE THE PROJECT BOUNDARIES

Proper disposal of materials outside the project boundaries shall be the responsibility of the Contractor. He shall make his own arrangements for the disposal of materials outside of the project boundaries and all the costs involved therein including the cost of hauling shall be considered as covered under the pay items involved in the Contract.

When any materials including excess or unsuitable materials from excavations are to be disposed of outside the project boundaries, the Contractor shall first obtain written permission from the property owner of the proposed disposal site. He shall submit to the Engineer the said written permission or a certified copy thereof, together with a written release from the property owner absolving the Government from any and all responsibilities in connection with the disposal of materials into his property. No material shall be disposed prior to the receipt of written approval and permission from the Engineer.

When materials are disposed of as provided above and if the site is visible from the highway, the Contractor shall make the disposal in a neat and presentable condition as to the satisfaction of the Engineer. The disposal site must not be an eyesore.

B.6C PROJECT RECORD DOCUMENTS**B.6C.1 Description**

Throughout the progress of the Works, the Contractor shall maintain the accurate records of all changes in the Contract Documents on a "Job Set" herein specified and shall transfer the final as built information to the Final Record Documents before the completion of the Works.

B.6C.2 Submittal Requirements

The Contractor shall submit or make available for review by the Engineer the job set of Project Record Documents as currently maintained on the 25th of each month. The Engineer's approval of these documents will be a prerequisite for approval of the Monthly Progress Payment Certificates.

The Contractor shall submit for the Engineer's approval the Final Project Record Documents at the time of application for Taking-Over Certificate. The Contractor shall accompany the submittal with a transmittal letter, containing:

- 1) Date;
- 2) Project title and number;
- 3) Contractor's name and address;
- 4) Title and number of each record document;
- 5) Certification that each document as submitted is complete and accurate; and

- 6) Signature of the Contractor, or his authorized representative.

B.6C.3 Project Record Documents

- 1) Job Set

Promptly following the Award of Contract, the Contractor shall obtain from the Engineer at no cost to the Contractor, two complete sets of all Documents comprising the Contract.

The Job Set will include (unless otherwise stated in the Contract) the following:

- Conditions of Contract
- Contract Drawings
- Technical Specifications
- Addenda
- Other Modifications to the Contract (if any)

- 2) Storage of Job Set

The job set shall be stored in the field office in files and in the racks. The Contractor shall maintain the job set protected from loss and damage until the transfer of as-built data to the Final Project Documents has been completed. The record documents shall not be used for construction purposes and the documents shall be available at all times for inspection by Engineer and Employer.

B.6C.4 Project Records for Materials & Equipment

All records concerning the testing and approval of materials and equipment to be incorporated into the Permanent Works shall form a part of the project records. The Contractor shall develop and maintain a record system which clearly shows the current status of all material sources, testing and approval. All approved samples shall be maintained at the job site.

B.6C.5 Update and Maintenance of the Job Set Documents

- 1) Responsibility

The Contractor shall delegate the responsibility for the maintenance of Record Documents to his authorized person with prior approval by the Engineer.

- 2) Identification

Immediately upon receipt of the job set, identify each of the documents with the title "PROJECT RECORD DOCUMENTS - JOB SET", in 5 cm high printed letters.

- 2) Preservation

Considering the Contract completion time, the probable number of occasions upon which the job set must be taken out for new entries and for examination, and the conditions under which these activities will be performed, the Contractor shall devise a suitable method for

protecting the job set with the approval of the Engineer.

4) **Marking Entries on Drawings**

Using an erasable colored pencil (not ink or indelible pencil); the Contractor shall clearly describe the change by notes and by graphic lines as required. The Contractor shall mark the date of all entries and call attention to the entry by a "cloud" around the area or areas affected. In the event of overlapping changes, different colors may be used for each of the changes. Record documents shall be kept current and works carried out must not be permanently concealed.

The Contractor shall legibly mark and record the actual construction details of the following:

- a) Depths of various foundation elements in relation to datum shown.
- b) Horizontal and vertical location of underground utilities shall be referenced to permanent surface improvements.
- c) Locations of internal utilities concealed in construction shall be referenced to visible and accessible features of structures.
- d) Field changes of dimension and detail.
- e) Changes made by Change Order.
- f) Details not on original Contract Drawings.

5) **Timing**

All entries shall be made within 24 hours after receipt of the information.

6) **Accuracy**

Use all the necessary means including the proper tools for measurement to determine the actual locations of the installed items and the accuracy of entries.

The Contractor shall thoroughly coordinate all the changes within the Record Documents and adequately and properly mark such changes on each page of the Specifications, on each sheet of Drawings and other Contract Documents. The accuracy of records shall be such that any future search for items shown on the Contract Documents may be obtained from the approved Record Documents.

B.6C.6 Final Record Documents

1) **General**

The purpose of the Final Record Documents is to provide factual information regarding all aspects of the Works, both concealed and visible, to enable future modification of design to proceed without lengthy and expensive site measurement, investigation and examination.

2) **Transfer of Data to Drawings**

Carefully transfer all changes of data shown on the job set of Record

Drawings to the corresponding original drawing of the Final Report Drawings and clearly indicate the full description of all changes made during construction and the actual location of all items. Call attention to each entry by drawing a "cloud" around the area or areas affected. Make all change entries on the originals neatly, consistently, and in ink or crisp black pencil.

3) Transfer of Data to Other Documents

If documents other than Drawings have been kept clean and neat during the progress of the Work, and if entries have been sufficiently and orderly transferred with the approval of the Engineer, the job set of those documents (other than Drawings) will be accepted by the Engineer as Final Record Documents. If any such document is not so approved by the Engineer, secure a new copy of that document from the Engineer and carefully transfer the change data to the new copy for the approval of the Engineer.

4) Review and Approval

Submit the completed set of Final Record Documents to the Engineer at the time of application for the Taking-Over Certificate. If requested by the Engineer, participate in a review meeting or meetings, execute any required changes and promptly re-submit the Final Record Documents to the Engineer for his acceptance.

5) Changes Subsequent to Acceptance

The Contractor shall have no responsibility of recording changes to the Works subsequent to the issue by the Engineer of the Taking-Over Certificate. He shall be responsible only for changes resulting from replacements, repairs, and alternations made by him as part of his guarantee or additional work that he has agreed to carry out during the Defects Liability Period.

B.7 CONSTRUCTION OCCUPATIONAL SAFETY AND HEALTH PROGRAM

In compliance with the DPWH Department Order No.56, S 2005, that all projects regardless of amount, funding source and mode of implementation shall comply with the minimum safety and health requirements.

Occupational hazards are continually emerging. Construction workers often encountered different types of hazards which may result to accidents, injuries and the worst is the loss of life.

Requirements

The Contractor shall employ a full-time Certified Safety and Health Personnel that is accredited by DOLE or the Department of Labor and Employment. This is in compliance with government regulations (OSHS and DO13). This full-time officer assigned as the general construction safety and health officer will oversee full time the overall management of Construction Safety and Health Program of the Contractor and its personnel working within the construction site. A requirement of one (1) Construction Safety and Health Officer for every ten (10) units of heavy equipment assigned to the project site, to oversee the

effective compliance with the Construction Safety and Health Program at the construction site, in terms of heavy equipment utilization and maintenance. Other requirements are medicines, supplies, equipment and facilities that conform to the OSHS.

Safety and Warning Signs

Mandatory provision of safety and warning signs are reiterated not only for the protection of workers, but also the public in general. The following signs should conform to the standard requirements of the OSHS;

- Usage of PPE
- Falling/falling objects
- Explosives and flammable substances
- Tripping or slipping hazards
- Toxic or irritant airborne contaminants/substances
- Electrical facility
- Dangerous moving parts of machines
- Fire alarms/fire fighting
- Instructional signs/Update of man-hours lost

Committee

Each site shall, at the start of the construction have a construction safety and health committee which is composed of the following personnel;

- Project Manager or his representative as the chairperson
- General Construction Safety and health Officer;
- Safety representative/SO from each subcontractor;
- Doctors, Nurses and Health personnel;
- Workers' representatives(min.of 3, not necessarily from one employer)

Monthly Summary Reports to DOLE

A monthly submission of Summary Reports to DOLE is required. The summary reports shall include safety committee meeting agreements and hazardous assessments with the corresponding remedial action/measured required.

The Contractor will send a notification of major accidents to DOLE within 24 hours.

Worker's Welfare Facilities

The Contractor shall provide to his workers for adequate supply of safe drinking water, adequate sanitary and washing facilities in order to ensure humane conditions of work.

The total cost of Construction Safety and Health Program shall be mandatory integral part of the construction project. It shall be treated as a separate pay item and reflected in the Contractor's bid.

The quantities of Construction Safety and Health Program shall be paid for in monthly basis as per the contract unit price indicated in the Bill of Quantities and upon recommendation and approval of the Engineer.

Payment and price shall constitute full compensation for the compliance and provision of necessary health and safety requirements listed above which conform to the standard requirements of the OSHS.

Payment will be made under:

Pay Item Number	Description	Unit of Measurement
B.7	Construction Occupational Safety and Health Program	Month

B.8 TRAFFIC MANAGEMENT DURING CONSTRUCTION

During construction, the Contractor shall provide access and temporary relocated roads as necessary to maintain and protect traffic on all affected road sections. Measures for the protection and diversion of traffic, including the provision of watchmen and flagmen, erection of barricades, placing of lights around and in front of equipment and the work, and the erection and maintenance of adequate warning, danger, and direction signs, shall be as required by the Engineer. The travelling public shall be protected from damage to person and property. The Contractor's traffic on the roads selected for hauling material to and from the site shall interfere as little as possible with the base traffic. The Contractor shall investigate the adequacy of the existing roads and the allowable load limit on these roads. The Contractor shall be responsible for the repair of any damage to roads caused by construction operations.

The Contractor shall employ a traffic management officer or Supervisor and necessary staff under him for the overall control of traffic management including the coordination with the national and local traffic authorities with jurisdiction over the project area, so as to minimize traffic obstruction and facilitate the flow of traffic through the construction area and through appropriate and approved diversion roads.

The construction area shall be bounded by steel fence as shown on the Drawings or as directed by the Engineer so that traffic can be more manageable. Informatory, regulatory and warning signs with proper lightings shall be installed wherever necessary. The Contractor shall coordinate his traffic management with the concerned government agencies and concerned private parties.

B.8.1 General

The Contractor shall furnish, install and maintain at all times for the duration of the Contract, necessary traffic signs, barricades, lights, signals and other traffic control devices and shall provide flagging and other means for guidance of traffic through the work zone. Traffic control shall be conducted in accordance with the prevailing government rules and regulations and where applicable, in accordance with the design details included in the Drawings.

All traffic signs and control devices furnished and installed by the Contractor shall be reviewed by the Engineer as to location, position, visibility, adequacy and manner of use under specific job conditions.

All traffic control devices necessary for the initial stage of construction shall be properly placed and in operation before any construction shall be allowed to start. When work of a progressive nature is involved, the necessary signs shall be moved to adjust to advancing operation.

If at any time, the Engineer determines that proper provisions for safe traffic control are not being provided or maintained, he may restrict construction operations affected by such defective signs or devices until proper satisfactory adjustments shall have been made. The Engineer may also suspend the entire work until the proper level of compliance is achieved.

In cases of serious or willful disregard of the Contractor for safety of the public or his employees, the Engineer may take appropriate corrective measures and deduct the cost thereof from moneys due or to become due to the Contractor.

The Contractor shall provide personnel to undertake continuous surveillance over his traffic control operations. Such personnel shall be available day and night to respond to calls involving damage to barricades, lights, signs, etc., either through vandalism or traffic accident. The Contractor shall identify such personnel to both the Engineer and local traffic authorities at the work zone.

The Contractor shall provide on the site the towing equipment to move stalled vehicles out of the traveled way to locations with no interference to traffic and the possibility of an accident.

B.8.2 Flaggers

Flaggers while on duty and assigned to traffic control or to give warning to the public that the highway is under construction and of any dangerous conditions to be encountered as a result thereof, shall perform their duties and shall be provided with the necessary equipment subject to the approval of the Engineer. The equipment shall be furnished and kept clean in good repair by the Contractor at his own expense.

B.8.3 Traffic Handling Equipment and Devices

All devices used by the Contractor in the performance of the work shall conform to the requirements of this Special Sub-item. Traffic handling-equipment and devices damaged from any cause during the progress of the work shall be repaired, including painting if necessary or replaced by the Contractor at his own expense.

When traffic control devices furnished by the Contractor are no longer needed for controlling traffic, they shall be removed from the site of the work.

B.8.4 Barricades

Barricades shall be constructed of lightweight commercial quality materials as approved by the Engineer. "A"-frame designs shall not be rigid.

Markings for barricades rails shall be alternate orange and white stripes. Reflective sheeting shall be replaced on rail surfaces in such a manner that no air bubbles or voids are present between the rail surface and reflective sheeting. The predominant color for barricade

components other than rails shall be white, except that unpainted galvanized metal or aluminum may be used.

Ballasting shall be by means of sand filled bags placed on the lower parts of the frame or stays, but shall not be placed on top of the barricade or over any reflectorized barricade rail face facing the traffic.

If the barricades are displaced or are not in an upright position, from any cause, said barricades shall immediately be replaced or restored to their original location, in an upright position at the Contractor's own expense.

B.8.5 Flashing Arrow Signs

Flashing arrow signs shall be finished with commercial quality flat black enamel and shall be equipped with yellow or amber lamps that form arrows or arrowheads are required. Each lamp shall be provided with a visor and the lamps shall be controlled by an electronic circuit that will provide between 30 to 45 complete operating cycles per minute in each of the displays and modes specified. The control shall include provisions for dimming the lamps by reducing the voltage to 50 percent, ± 5 percent, for night time use. Type I signs shall have both manual and automatic photoelectric dimming controls. Dimming in both modes shall be continuously variable over the entire dimming range.

Flashing arrow signs shall conform to the following legibility requirements. The minimum legibility distance is the distance at which flashing arrow signs shall be legible at noon on a cloudless day and at night by persons with vision of or corrected to 20/20.

Type	Minimum Size	Min. Number of Panel Lamps	Min. Legibility Distance
I	1220 mm x 2440 mm	15	1600 m
II	610 mm x 1220 mm	13	1200 m

Flashing arrow signs shall be capable of being operated in 4 different display modes as follows. The display to be used shall be as directed by the Engineer.

- 1) Pass Left Display
- 2) Pass Right Display
- 3) Simultaneous Display
- 4) Caution Display

Flashing arrow signs shall also be capable of operating in one or both of the following modes, at the option of the Contractor:

- 1) Flashing Arrow Mode
- 2) Sequential Mode

In the flashing arrow mode, all lamps forming both the arrowhead and shaft shall flash on and off simultaneously.

In the sequential mode, either arrowheads or arrows shall flash sequentially in the direction indicated. In the caution display mode, a combination of lamps not resembling any other display or mode shall flash.

Each flashing arrow sign shall be mounted on a truck or on trailer and shall be capable of operating while the vehicle is moving and shall be capable of being placed and maintained in operation at locations as shown on the Drawings, or as directed by the Engineer.

Flashing arrow signs shall be mounted to provide a minimum of 2.10 meters between the bottom of the sign and the roadway. Trailers on which flashing arrow are mounted shall be equipped so that they can be levelled and plumbed.

Electrical energy to operate the sign shall be obtained from the vehicle on which the sign is mounted or from a generating plant mounted on said vehicle. Regardless of the sources, the supply of electrical energy shall be capable of operating the sign in the manner specified.

B.8.6 Portable Delineators

Portable delineators, including the base, shall be composed of a material that has sufficient rigidity to remain upright when unattended and shall be either flexible or collapsible upon impact by a vehicle. The base shall be of such shape as to preclude roll after impact.

The base shall be sufficient weight or shall be anchored in a manner such that said delineator shall remain in an upright position. Ballast if used for the bases of portable delineators shall be sand or water.

If the portable delineators are displaced or are not in an upright position, from any cause said delineators shall immediately be replaced or restored to their original location, in an upright position, by the Contractor.

The vertical portion of the portable delineators shall be of a fluorescent orange or predominantly orange colour. The posts shall be not less than 76 mm in width or diameter. The minimum height shall be 910 mm above the travelled way or as shown on the Drawings.

A minimum of 2 reflective bands each not less than 76 mm wide, shall be mounted a minimum of 38 mm apart and at a height on the post so that one reflective band will be between 0.76 m and 0.91 m above the roadway surface.

Reflective bands shall be white and shall be fabricated from flexible reflective sheeting as specified in the special provisions. The reflective bands shall be visible at 305 meters at night under illumination of legal high beam headlights, by persons with vision of or corrected to 20/20.

Only one type of portable delineator shall be used on the project. The type of portable delineator proposed for use on the project shall be submitted to the Engineer for approval prior to replacement on the project.

B.8.7 Portable Flashing Beacons

Each portable flashing beacon unit shall consist of a lighting unit, a flasher unit, a standard, a battery power source and a base. The units shall be assembled to form a complete, self-contained, flashing beacon which can be delivered to the site of use and placed in immediate operation.

The lens for the beacon lighting unit shall have a visible diameter of 300 mm. The lens shall be glass or plastic conforming to the provisions in ANSI Standard: D-10 for yellow traffic signal lens.

The beacon lighting unit shall be provided with a 200 mm minimum length of visor and a back plate. Visors will not be required during the hours of darkness.

The flasher unit shall provide 50 to 60 flashes per minute with 250 to 350 milliseconds dwell time.

The standard shall be adjustable to provide a variable mounting of the lighting unit between 1.8 and 3 meters measured from the bottom of the base to the center of lens, with provisions for securing the standard at the desired height. The standard shall be securely attached to the base and a sufficient length of multi-conductor, neoprene jacketed cable as required for full vertical height shall be provided.

The base shall be large enough to accommodate a minimum of two 12 volt, automotive type storage batteries and shall be of such shape and weight that the beacon will not roll in the event it is struck by a vehicle or pushed over.

The lamp shall be rated at 25 watts for operation on 12-volt battery current.

The flashing beacon assembly shall be weatherproof and shall be capable of operating a minimum of 150 hours between battery recharging and other routine maintenance.

The standard and base shall be finished with 2 applications of commercial quality orange enamel. The interior of the visor and the front face of the back plate shall be finished with 2 applications of commercial quality flat black enamel.

B.8.8 Construction Area Signs

The term "Construction Area Signs" shall include all temporary signs required for the direction of public traffic through or around the work during construction operation. Construction area signs shall be installed at the locations shown on the Drawings or as directed by the Engineer.

Construction area signs designated as stationary-mounted on the drawings shall conform to the provisions in Sub-Section B.8.9, "Stationary Mounted Signs" and construction signs designated as portable signs on the Drawings shall conform to the provisions in Sub-Section B.8.10, "Portable Signs".

Construction area signs not designated as stationary mounted nor as portable on the plans shall be, at the Contractor's option, either stationary mounted or portable signs conforming to the provisions in said Sub-Sections B.8.9 or B.8.10.

All construction area signs shall conform to the dimensions, color and legend requirements of the Drawings and these specifications. All sign panels shall be the product of a commercial sign manufacturer, and shall be as specified in these specifications.

Sign panels for all construction area signs shall be visible at 150 meters and legible at 90 meters at noon on a cloudless day and at night under illumination of legal low beam headlights, by persons with vision of or corrected to 20/20, except that the night time requirement shall not apply to fabric sign panels for portable signs.

The Contractor may be required to cover certain signs during the progress of the work. Covers for construction area signs shall be of sufficient size and density to completely block out the message so that it is not visible either during the day or at night. Covers shall be fastened securely to prevent movement caused by wind action. The Contractor shall clean all construction area sign panels at the time of installation and as often thereafter as the Engineer determines to be necessary, but at least once every 4 months.

Signs with the specified sheeting material will be considered satisfactory if they conform to the requirements for visibility and legibility and colors conform to the requirements as directed by the Engineer. A significant difference between day and nighttime reflective colour will be grounds for rejecting signs.

To properly provide for changing traffic conditions and damage caused by public traffic or otherwise, the Contractor shall be prepared to furnish on short notice additional construction area sign panels, posts and mounting hardware or portable sign mounts. The Contractor shall maintain an inventory of the commonly required items at the jobsite or shall make arrangements with a supplier who is able, on daily basis, to furnish such items on short notice.

B.8.9 Stationary Mounted Signs

Stationary mounted signs shall be installed on wood posts in the same manner shown on the Drawings or as directed by the Engineer. Stationary mounted signs shall be installed in accordance with the following guidelines:

- 1) Use of back braces and blocks for sign panels will not be required.
- 2) The height to the bottom of the sign panel above the edge of travelled way shall be at least 1.50 meters, except when the sign is located in the path of pedestrians or bicycles the height to the bottom of the sign panel above the edge of the travelled way shall be at least 2.10 meters.
- 3) Construction area sign posts may be installed on above ground temporary platform sign supports as approved by the Engineer, or

the signs may be installed on existing lighting standards or other supports as approved by the Engineer. When the construction area signs are installed on existing lighting standards, holes shall not be made in the standards to support the sign.

- 4) The post embedment shall be 0.76 meter. If post holes are backfilled around the posts with portland cement concrete produced from commercial quality aggregates and cement with not less than 168 kilograms of cement per cubic meter.

Post size and number of posts shall be as shown on the plans, except that when stationary mounted signs are installed and the type of sign installation is not shown on the plans, post size and the number of posts will be determined by the Engineer. Posts shall be good sound wood post, suitable for the purpose intended.

Sign panels for stationary mounted signs shall consist of reflective aluminium sheeting. Sign panels shall conform to the requirements specified in Item 605. Legend and border may be applied by a screening process or by use of pressure sensitive cut-out sheeting. Size and spacing of letters and symbols shall be as depicted on the sign specification sheets published by the Department.

All rectangular sheet aluminium signs over 140 centimetres measured along the horizontal axis and all diamond-shaped sheet aluminium signs 152 centimetres and larger shall be framed unless otherwise specified. Frames shall be constructed in accordance with Item 605. Sign panel fastening hardware shall be commercial quality.

B.8.10 Portable Signs

Each portable sign consist of a base, standard or framework and a sign panel.

The units shall be capable of being delivered to the site of use and placed in immediate operation.

Sign panels for portable signs shall conform to the requirements of sign panels for stationary mounted signs in Section B.8.9, "Stationary Mounted Signs" or shall be cotton drill fabric, flexible industrial nylon fabric, or other approved fabric.

Fabric signs shall not be used during the hours of darkness. Size, color and legend requirements for portable signs shall be as described for stationary mounted sign panels in said Sub-Section B.8.9.

The sign standard or framework shall be capable of supporting a sign panel of 120 centimetres by 120 centimetres maximum dimension, in an upright position with the centre of the sign panel a minimum of 1.50 meters above the pavement.

All parts of the sign standard or framework shall be finished with 2 applications of orange enamel which will match the colour of the sign panel background. Testing of paint will not be required.

If portable signs are displaced or overturned, from any cause, during

the progress of the work, the Contractor shall immediately replace the signs in their original locations at his own expense.

B.8.11 Telescoping Flag Trees

Telescoping flag trees shall be of good commercial quality material, suitable for the purpose intended and shall be capable of maintaining an upright position at all times while in use.

B.8.12 Traffic Cones

Traffic cones shall be fluorescent and of good commercial quality, flexible material suitable for the purpose intended. The outer section of the portion above the base of the cone shall be translucent and be of a highly pigmented fluorescent orange polyvinyl compound. The overall height of the cone shall be at least 710 millimetre and the bottom inside diameter shall be not less than 267 millimetre. The base shall be of sufficient weight and size or shall be anchored in a manner such that the traffic cone will remain in an upright position.

During the hours of darkness traffic cones shall be affixed or covered with a minimum 330 millimetre flexible reflective cone sleeve, placed a maximum of 76 millimetre from the top of the cone. The sleeves shall be white and shall be fabricated from the reflective sheeting. The reflective sheeting shall be visible at 305 meters at night under illumination of legal high beam headlights, by persons with vision of or corrected to 20/20.

Traffic cones to be in place during daylight hours shall not be affixed or covered with reflectorized cone sleeves.

B.8.13 Measurement and Payment

Traffic management during construction shall be accounted and paid for by the actual provision and furnishing of all traffic management requirements and as per the necessity for the maintenance and safety of the traveller and as well as the total safety of the project. The price shall also include everything mentioned above and payment will be in prorated form and as per actual accomplished provisions and duly certified and approved by the Engineer.

Payment will be made under:

Pay Item No.	Description	Unit of Measurement
B.8	Traffic Management	Lump Sum

B.9 MOBILIZATION/DEMOBILIZATION (CLEARING/FINISHING THE SITE)

Upon completion of all construction operations, the entire roadway or roadways shall be finished/cleared as specified herein these Specifications.

Stockpiling of materials on the finished pavement and drifting of materials across the pavement will not be permitted. The finished pavement shall be cleaned of all dirt and foreign materials.

The slopes in embankments; excavations; road approaches; road connections; ditches; channel changes; and material sites within or adjacent to the project boundaries shall be cleared and finished to the lines and grades called for on the Drawings. Ditches and channels within or adjacent to the project boundaries shall be cleared of debris and obstructions. Sewers, culverts and other drainage facilities and their appurtenant structures constructed under the contract shall be cleaned out. All stores and other waste materials exposed on slopes, which are liable to become loosened, shall be removed and disposed of. All materials and debris resulting from clearing and grubbing operations not previously removed shall be disposed of.

All materials resulting from the above-specified clearing/finishing operations shall become the property of the Contractor and shall be disposed of outside the project boundaries unless otherwise permitted by the special provisions.

Disposal of materials outside the highway right of way shall be in accordance with the provision in Item B.8, "Disposal of Materials outside the Project Boundaries". The entire roadway and right of way shall be left in a neat and presentable condition.

Payment for this Item shall be in n Lump Sum basis and divided into two(2) parts; Part A-Mobilization, once the Contractor had mobilized his staff/manpower, equipment requirements and his facilities for the project and Part B-Demobilization, once the Contractor had completed his works and everything cleared on site including clean-up and removal of all his installations/plants.

The basis of payment can be done on a staggered or percentage form based upon his actual mobilization and demobilization status. The Contractor's claim for each shall be inventoried and upon recommendation and approval of the Engineer.

Payment and price shall constitute the full compensation for the compliance of the above specifications on mobilization and demobilization.

Payment will be made under:

Pay Item Number	Description	Unit of Measurement
B.9	Mobilization and Demobilization	Lump Sum

B.10 METHOD OF MEASUREMENTS

B.10.1 Measurement of Quantities

In measuring all acceptable completed bid items of work, the Engineer will:

- 1) Use SI metric standard measure;
- 2) Make all measurements as described in this Item, unless individual specifications require otherwise;
- 3) Follow methods generally recognized as conforming to good engineering practice;

- 4) Conform to the usual practice of the Employer by carrying measurements and computations to the proper significant figure or fraction of units for each item, but not exceeding one decimal place; and
- 5) Measure horizontally or vertically (unless otherwise specified).

The items listed below shall be defined as follows in all measurements under this item:

- 1) "Lump Sum" (when used as an item of payment): complete payment for the work described for that item in the contract.
- 2) "Gage" (in measurement of plates): the U.S Standard Gage.
- 3) "Gage" (in measurement of galvanized sheets used to manufacture corrugated metal pipe, metal plate, pipe culverts and arches, and metal cribbing): that specified in AASHTO M 36, M 167, M 196, M 197, or M 219.
- 4) "Gage" (in measurement of wire): that specified in AASHTO M 32.
- 5) "Ton": The metric ton equal to 1,000 kilograms of weight.

For each basis of measurement listed below, the Engineer will use the method of measurements as described herein.

- 1) Square Meter or Hectare - Measured on the neat dimensions shown on the Drawings or dimensions altered by the Engineer.
- 2) Linear Meter (pipe culverts, guard rail, under drains, etc.) - measured parallel to the structure's base or foundation or unless the Drawings require otherwise.
- 3) Weight - weighed as required in Item B.10.2.

Volume (of excavation and embankment) - measured by the average-end-area method. All or some computations may be based on ground elevations and other data derived photogram metrically. The Engineer may correct for curvature.

For each item listed below, the Engineer will use the method of measurement described herein as:

Structure - measured on the neat lines shown on the Drawings or to dimensions altered by the Engineer. When a complete structure or structural unit is specified as the unit of measurement, the unit shall include all fittings and accessories.

Standard Manufactured Items (fence, wire, plats, rolled shapes, pipe conduit, etc., when specified) - measured by the manufacturer's identification of gage, unit weight, section dimension, etc. The Engineer will accept manufacturing tolerances set by each industry unless cited specifications require more stringent tolerances.

- Cement - measured by bags
- Asphalt - measured by the ton.

No measurement will be made for:

- (1) Work performed or materials placed outside lines shown on the Drawings or set by the Engineer;

- (2) Materials wasted, used or disposed of in manner contrary to the contract;
- (3) Rejected materials (including those rejected after placement if the rejection resulted from the Contractor's failure to comply with the contract);
- (4) Hauling and disposing of rejected materials;
- (5) Material remaining on hand after the work is completed, except as provided in the contract; and
- (6) Any other work or material contrary to any contract provision.

B.10.2 Weighing Equipment

B.10.2.1 General Requirements for Weighing Equipment

Any highway or bridge construction materials to be proportioned or measured and paid for by weight shall be weighed on scales. These materials include natural, manufactured, or processed materials obtained from natural deposits, stockpiles, or bunkers. The Contractor shall provide, set up, and maintain certified scales to their good weighing condition and use it permanently all throughout weighing work.

Scales shall:

- 1) Be accurate to within one-half of 1 percent throughout the range of use;
- 2) Not include spring balances;
- 3) Include beams, dials, or other reliable readout equipment;
- 4) Be arranged so that operators and inspectors can safely and easily see dials, beams, rods, and operating scale mechanisms;
- 5) Be built to prevent scale parts from binding, vibrating, or being displaced and to protect all working parts from falling material, wind, and weather; and
- 6) Be carefully maintained, with (a) bunkers and platforms kept clear of accumulated materials that could cause errors and (b) knife edges given extra care and protection.

At each batching and platform scale location, the Contractor shall keep standard weights for scale calibration and testing. If the Engineer has approved other calibration and testing equipment, the Contractor may substitute it for these weights.

B.10.2.2 Specific Requirements for Batching Scales

All materials proportioned by weight shall be weighed on an accurate and approved scale by qualified operators employed by the Contractor. The scales shall be positioned at locations required and approved by the Engineer.

Each scale shall be designated to support a weighing hopper. The arrangement shall make it convenient for the operator to remove material from the hopper while watching read-out devices. Any hopper mounted on a platform scale shall have its center of gravity directly over the platform centerline.

Marked intervals on the read-out device shall be spaced evenly throughout and shall be based on scale's nominal rated capacity. These intervals shall be at least 0.5 kilogram but shall not exceed one-tenth of 1 percent of nominal rated capacity.

An agent of the scale manufacturer shall test and service any batch scale before its use at each new site and then at 6-month intervals. The Contractor shall provide the Engineer a copy of the final results after each test. Whenever the Engineer requests, the Contractor's operator(s) shall test the scale while the inspector observes.

Portland or asphalt cement shall be weighed on a scale not used for other materials.

B.10.2.3 Measurement

If testing shows the scale has been under weighing, it shall be adjusted immediately. The Contractor shall not be compensated for any loss from under weighing. If the scale has been overweighing, its operation will cease immediately until adjusted. The Employer will calculate the combined weight of all materials weighed after the last test showing accurate results. This combined weight will then be reduced by the percentage of scale error that exceeds one-half of 1 percent.

B.10.2.4 Payment

The Employer will pay for no materials received by weight unless they have been weighed as required in this Item or as required by another method the Engineer has approved in writing. Payment will not be made for any material over the maximum gross legal weight for the hauling vehicle.

Unit contract prices for the various pay items of the project cover all costs related to weighing and proportioning materials for payment. These costs include those for furnishing, installing, certifying, and maintaining scales, those for furnishing check weights and scale house, and those for any other related item covered in this specification.

B.11 SILENCE OF CONTRACT DOCUMENTS

The apparent silence of the Drawings, Specifications, Supplemental Specification, and Special Provisions, as to any detail or the apparent omission of a detailed description concerning any point shall be regarded as meaning that only the best general practice is to prevail and that only material and workmanship of first class quality are to be used. All interpretation of the Contract Documents shall be made by the Engineer on the basis stated above.

B.12 MEETINGS/CONFERENCES

As often as possible or as necessity arises, meetings/conferences shall be held to discuss matters of detail i.e. construction sequences, progress, materials,

procedures, temporary works, quality control and similar subjects pertinent to the satisfactory execution of the Works, or to discuss problems arising out of the implementation of the Project.

Such meetings/conferences shall not be less frequent than twice a month and shall be attended by the Project Manager of the Contractor and by the Engineer or his representative.

Minutes of the Meetings/Conferences shall be officially documented, confirmed or concurred to by the Contractor, copy thereof submitted to the Employer, properly dated and numbered.

B.13 MEASUREMENT AND PAYMENT

Unless specifically included in the Bill of Quantities as pay item(s) of work, under PART B – OTHER GENERAL REQUIREMENTS, the work(s) shall not be measured for direct payments but shall be considered as subsidiary work for other related pay Items.

Payment will be made under:

Pay Item Number	Description	Unit of Measurement
B.2	Medical Room and First Aid Facilities	Lump Sum
B.4 (1)	Construction Survey and Staking	Kilometer
B.4 (2)	Slope, Reference, Clearing and Grubbing Staking	Kilometer
B.4 (3)	Centerline Reestablishment	Kilometer
B.4 (4)	Culvert Survey and Staking	Each
B.4 (5)	Bridge Survey and Staking	Lump Sum
B.4 (7)	Grade Finishing Stakes	Kilometer
B.4 (8)	Permanent Monuments and Markers	Each
B.5	Project Sign Board	Each
B.7	Construction Occupational Safety and Health Program	Month
B.8	Traffic Management	Lump Sum
B.9	Mobilization and Demobilization	Lump Sum

PART C

EARTHWORKS

PART C EARTHWORK**ITEM 100 CLEARING AND GRUBBING****100.1 Description**

This Item shall consist of the removal, hauling, and stockpiling of all materials including trees, stumps, roots, vegetations, logs, wastes, debris and protruding objects except those that are designated to remain in accordance with other items of this Specification and where directed by the Engineer. The holes resulting from clearing and grubbing operations, where directed by the Engineer, shall be filled with approved materials, which shall be placed and compacted to the maximum dry density. The work shall also include the preservation from injury or defacement of all objects designated to remain.

100.2 Construction Requirements**100.2.1 General**

The Engineer will establish the limits of work and designate all trees, shrubs, plants and other things to remain. The Contractor shall preserve all objects designated to remain. Paint required for cut or scarred surface of trees or shrubs selected for retention shall be an approved asphaltum base paint prepared especially for tree surgery.

Clearing shall be extended to one (1) meter beyond the toe of the fill slopes, or beyond rounding of cut slopes or outside edge of drainage facilities, unless otherwise shown on the Drawings or directed by the Engineer, with the exception of trees under the jurisdiction of the Forest Management Bureau and/or such tree and brush designated for preservation. Trees, shrubs or bushes designated to remain in place shall be carefully trimmed as directed by the Engineer and shall be protected from scarring, debarking and other injuries during construction operations.

Within the town or village areas, clearing and grubbing shall be strictly limited to the extent of cut and fill as shown in the Drawings or as designated by the Engineer. No private properties such as buildings, crops, signs, fences, and others shall be removed, relocated or altered without the written authorization from the Engineer.

Structures, properties and the likes which need to be removed but are still under legal expropriation proceedings shall in the meantime be preserved or excluded from the works, otherwise the Contractor shall be solely liable for any complaints or litigation filed by the owner of any damage to the structure and/or property as a result of his action.

Any unauthorized interference and damage to private property shall be made good or restored by the Contractor to the satisfaction of the Engineer and the Owner.

100.2.2 Clearing and Grubbing

All surface objects and all trees, stumps, roots and other protruding obstructions, not designated to remain shall be cleared and/or

grubbed, including mowed as required, except as provided below;

- (1) Removal of undisturbed stumps and roots and nonperishable solid objects with a minimum depth of one (1) meter below subgrade or slope of embankment will not be required.
- (2) In areas outside of the grading limits of cut and embankment areas, stumps and nonperishable solid objects shall be cut off not more than 150mm above the ground line or below water level.
- (3) In areas to be rounded at the top of cut slopes, stumps shall be cut off flush with or below the surface of the final slope line.
- (4) Grubbing of pits, channel changes and ditches will be required only to the depth necessitated by the proposed excavation within such areas.
- (5) In areas covered by cogon/talahib, wild grass and other vegetations, top soil shall be cut to a maximum depth of 150mm below the original ground surface or as designated by the Engineer, and disposed outside the clearing and grubbing limits as indicated in the typical roadway section.

Unless otherwise directed by the Engineer, materials from clearing and grubbing and other unsuitable materials shall be delivered and stockpiled at the approved designated areas.

100.2.3 Individual Removal of Trees or Stumps

The Contractor, prior to any tree cutting/removal operation shall prepare inventory of the trees scheduled for cutting/removal for the Engineer's approval. List of trees to be cut shall be submitted in tabulated form, showing as much information for easy identification as follows:

- Station Limit
- Description/Name/Species of Trees
- Size/Diameter (in centimeter)
- Distance from the centerline of the road
- Location (Left/Right)

Upon Engineer's approval of the list, the Contractor shall make a request from the Local DENR (with the approved list attached) that such number of trees will be cut/removed for the improvement of the project road. No trees shall be cut/removed unless a "Permit to Cut Trees" is issued by the DENR to the Contractor authorizing him to cut only such approved number of trees.

Trees cut shall be disposed of in a manner conforming to the requirements of Sub-Section 100.2.2 and with the requirements contained in the DENR permit.

All fees relating to securing permit(s) shall be to expense of the Contractor.

Individual trees or stumps intended to be removed and relocated as indicated on the Drawings or as designated by the Engineer shall be removed and relocated by the Contractor with care.

100.3 Method of Measurements

Measurement will be by one or more of the following alternate methods;

- (1) Area Basis. The work to be paid for shall be based on the total number of hectares and fractions thereof acceptably cleared and grubbed within the limits indicated on the Plans/Drawings or may be adjusted in the field staking by the Engineer. Areas not within the clearing and grubbing limits shown in the Plans/Drawings or not staked for clearing and grubbing will not be measured for payment.
- (2) Lump-Sum Basis. When the Bill of Quantities contains a Clearing and Grubbing lump-sum item, no measurement of area will be made for such item.
- (3) Individual Unit Basis (Selective Clearing). The diameter of trees will be measured at a height of 1.4m (54 inches) above the ground. Trees less than 150mm (6 inches) in diameter will not be measured for payment.

When Bill of Quantities indicates measurement of trees by individual unit basis, the units will be designated and measured in accordance with the following schedule of sizes:

Diameter at height of 1.4 m	Pay Item Designation
150mm to 900mm diameter	Small
Over 900mm diameter	Large

100.4 Basis of Payment

The accepted quantities, measured as prescribed in *Section 100.3*, shall be paid for at the Contract unit price for each of the Pay Items listed below that is included in the Bill of Quantities, with price and payment shall be full compensation for furnishing of labor, equipment, tools and incidentals necessary to complete the work prescribed in this Item.

Payment will be made under:

Pay Item Number	Description	Unit of Measurement
100(1)	Clearing and Grubbing	Hectares
100(3)a2	Individual Removal of Trees, Small (301-500mm diameter)	Each
100(3)a4	Individual Removal of Trees, Small (751-900mm diameter)	Each

ITEM 102 EXCAVATION**102.1 Description**

This Item shall consist of roadway drainage and borrow excavation, and the disposal of material in accordance with this Specification and in conformity with the lines, grades and dimension shown on the plans or establishes by the Engineer.

It shall be understood that the hauling of excavated fill material to stockpiles or its hauling to areas of fill and the disposal of unsuitable materials to disposal areas is at any distance and therefore no overhauling cost will be paid.

102.1.1 Roadway Excavation

Roadway excavation will include excavation and grading of roadways, parking areas, intersections, approaches, slope rounding, benching, waterways and ditches; removal of unsuitable material from the roadbed and beneath the embankment areas; and excavating selected materials found in the roadway as ordered by the Engineer for specific use in the improvement. Roadway excavation will be classified as "unclassified excavation", "rock excavation", "common excavation", or "muck excavation" as indicated in the Bill of Quantities and hereinafter described.

- 1) Common Excavation. Common excavation shall consist of all excavation including any pavement layer of the existing roadway not covered by a separate item in the Bill of Quantities regardless of the nature of the materials excavated, other than borrow excavation, unsuitable excavation, soft rock and solid rock excavation.

Common excavation shall include excavation for the reshaping of side ditches in accordance with the lines, levels and details shown on the drawings and as per instruction by the Engineer.

- 2) Rock Excavation. Rock excavation shall consist of excavation of igneous, sedimentary and metamorphic rocks which cannot be excavated without blasting or the use of rippers, and all boulders or detached stones each having a volume of 1 cubic meter or more as determined by physical measurements or visually by the Engineer.

A.) Soft Rock Excavation shall consist of excavation of rock which can be effectively removed by ripping with a tractor of 150kw (200 Flywheel HP) equipped with a rear mounted heavy-duty hydraulic ripper.

B.) Hard/Solid Rock Excavation shall consist of hard material in masses (including individual rock boulders exceeding 1.0 m³ in volume) which in the opinion of the Engineer cannot be excavated without blasting.

Hard/solid rock excavation shall include all materials that cannot be ripped when worked with a tractor of at least 150 KW (200 Flywheel HP) fitted with a rear mounted heavy-duty hydraulic single ripper and requires either of the following:

- a. Requires drilling and blasting for its removal or,
- b. Requires the use of compressed air jack hammers for its removal.

Individual boulders greater than 1 cubic meter in volume shall be included in this class when the nature and size are such that in the opinion of the Engineer it cannot be removed without recourse to one of the above methods.

Where a portion of excavation contains 50% or more by volume of boulders of this order, such portion shall be considered as hard/solid rock excavation throughout

- 3) Muck Excavation. Muck excavation shall consist of removal and disposal of deposits of saturated or unsaturated mixtures of soils and organic matter such as muck, peat, organic silt, soil or sod, which is not suitable for foundation materials regardless of moisture content. This is sometimes considered as Unsuitable Excavation and will be for the opinion and approval of the Engineer.
- 4) Unclassified Excavation. Unclassified excavation shall consist of the excavation and disposal of all materials regardless of the nature, not classified and included in the Bill of Quantities under other pay items.

102.1.2 Borrow Excavation

Borrow excavation shall consist of the excavation and utilization of approved materials required for the construction of embankments or for other portions of the work, and shall be obtained from approved sources, in accordance with Clause 61, Standard Specifications for Public Works and Highways, Volume 1 and the following;

- (1) Borrow, Case 1
Borrow Case 1 will consist of material obtained from sources designated on the plans or in the Special Provisions.
- (2) Borrow, Case 2
Borrow Case 2 will consist of material obtained from sources provided by the Contractor.

The material shall meet the quality requirements determined by the Engineer unless otherwise provided in the Contract.

Irrespective of the source of borrow materials whether as indicated in the Drawings, or as directed by the Engineer or from the Contractor's own source, it is understood that materials obtained from these

sources are only of the desired quality passing the requirements of the Specifications. All preparatory works, problems of access and other related matters in connection with quarrying operations shall be the sole responsibility of the Contractor.

102.2 Construction Requirements

102.2.1 General

When there is evidence of discrepancies on the actual elevations and that shown on the Plans, a pre-construction survey referred to the datum plane used in the approved Plan shall be undertaken by the Contractor under the control of the Engineer to serve as the basis for the computation of the actual volume of the excavated materials.

All excavations shall be finished to reasonably smooth and uniform surfaces. No materials shall be wasted without the authority of the Engineer. Excavation operations shall be conducted so that material outside of the limits of slopes will not be disturbed. Prior to excavation, all necessary clearing and grubbing in that area shall have been performed in accordance with Item 100, Clearing and Grubbing.

102.2.2 Conservation of Topsoil

Suitable topsoil encountered in excavation and on areas where embankment is to be placed shall be removed to such extent and to such depth as directed by the Engineer. The removed topsoil shall be transported and stockpiled at locations approved by the Engineer. The topsoil shall be completely removed to the required depth from any designated area prior to the beginning of regular excavation or embankment work in the area and shall be kept separately from other excavated materials for later use.

102.2.3 Utilization of Excavated Materials

All suitable materials removed from the excavation shall be used in the formation of the embankment, subgrade, shoulders, slopes, bedding, and backfill for structures, and for other purposes shown on the Plans or as directed by the Engineer.

Only approved materials shall be used in the construction of embankments and backfills.

All excess materials, including rock and boulders that cannot be used in embankments shall be disposed off as directed by the Engineer.

Borrow Materials shall not be placed until after the readily accessible materials from roadway excavation has been placed in the fill, unless otherwise permitted or directed by the Engineer. If the Contractor places more borrow than is required and thereby causes waste of excavation, the amount of such waste will be deducted from the borrow volume.

102.2.4 Prewatering

Excavation areas and borrow pits maybe prewatered before

excavating the material. When prewatering is used, the areas to be excavated shall be moistened to the full depth, from the surface to the bottom of the excavation. The water shall be controlled so that the excavated material will contain the proper moisture to permit compaction to the specified density with the use of standard compacting equipment.

The Contractor shall provide drilling equipment capable of suitably checking the moisture penetration to the full depth of the excavation.

102.2.5 Presplitting

Unless otherwise provided in the Contract, rock excavation, which requires drilling and shooting, shall be presplit.

Explosives maybe used only when authorized in writing by the Engineer, in accordance with the provisions of all laws, orders and regulations. The Engineer's approval on the use of explosives shall, in no case relieve the Contractor from any liability for claims caused by blasting operations.

The Contractor at all times shall, with the Engineer's permission, use materials containing hazardous substances with strict compliance to safety requirements and all manufacturer's warning, application instruction and specifications.

Regardless of the variance allowed in the formation of slope in rock excavations, only the volume within the limits indicated in the drawings, unless adjusted by the Engineer, shall be considered as pay quantity.

102.2.6 Excavation of Ditches, Gutters, etc.

All materials excavated from side ditches and gutters, channel changes, irrigation ditches, inlet and outlet ditches, toe ditches, furrow ditches, and such other ditches as may be designated on the Plans or staked by the Engineer, shall be utilized as provided in Subsection 102.2.3.

Ditches and side ditches at cut sections, whether on rock or on common soil, shall conform to the slope, grade and shape of the required cross-section, with no projections of the roots, stumps, rock, or similar matter. The Contractor shall maintain and keep open and free from leaves, sticks and other debris all ditches dug by him until final acceptance of the work.

At sections of fill where the original ground and toe of slope of the designed road meet, and where the original ground slopes away from the intersection such that run off water does not accumulate and flow freely away from the roadbed, drainage ditch will not be necessary. However, if the ground slopes down towards the roadbed, the provisions of drainage ditches to convey run-off water away from the road will be necessary whether or not indicated on the drawings. Whenever the longitudinal gradient of drainage ditches constructed on common soil exceeds the maximum allowed by the drawings or when the conditions exist, which in the opinion of the Engineer, will result to damage of the roadbed through the action of erosion, the Contractor

may be required to provide the corresponding protection. Erosion control protection whenever required shall be constructed in accordance to the relevant provisions of Part G- Drainage and Slope Protection Structures.

Structures to be constructed related to erosion control shall be measured and paid for in accordance with the relevant items in the Bill of Quantities under Part G: Drainage and Slope Protection Structures and Part H: Miscellaneous Structures of the Specifications, whichever is appropriate.

102.2.7 Excavation of Roadbed Level

Rock shall be excavated to a depth of 150 mm below the subgrade within the limits of the roadbed, and the excavation be backfilled with material designated on the Plans or approved by the Engineer and compacted to the required density.

Materials below subgrade, other than rock shall be thoroughly scarified to a depth of 150 mm and the moisture content increased or reduced, as necessary, to bring the material throughout this 150mm layer to the moisture content suitable for maximum compaction. This layer shall then be compacted in accordance with Subsection 104.3.4 (Embankment-Compaction).

Tolerance for excavation shall be as follows:

- Cut Slopes in Soils shall be plus or minus one hundred millimeters (+/- 100 mm)
- Cut Slopes in Soft Rock and Blasted Rock shall be plus or minus three hundred millimeters (+/- 300 mm)

102.2.8 Borrow Areas

Material from borrow areas shall be used for the construction of embankment or for backfill when there is no suitable materials available from roadway excavation or structural excavation or excavation of ditches or waterways. Permission to use material from borrow areas shall first be obtained from the Engineer. Nevertheless, the total volume of material from roadway excavation, ditch and watercourse excavations, and structure excavation less the materials declared unsuitable by the Engineer shall be considered available for use in the work regardless of haul distance. Surplus materials resulting from the Contractor's use of borrow materials, without first exhausting the available common excavation, shall not be measured for payment.

No borrow material shall be taken nearer than 30 meters from the toe of embankment or top of the cuts, unless called for in the widening of cuts or authorized by the Engineer. The distance from the work sites shall not be grounds for any claims for extra payment or revision of the contract price.

In addition, no borrow material shall be obtained from any area within two hundred (200) meters downstream of the drainage structure without the approval of the Engineer.

The Contractor shall notify the Engineer sufficiently in advance of opening any borrow area so that the cross-section elevations and measurements on the ground surface after stripping maybe taken, and the borrow material can be tested before being used. Sufficient time for testing the borrow material shall be allowed.

102.2.9 Removal of Unsuitable Materials

In general, whenever materials of doubtful characteristics are discovered during excavation and embankment construction, such materials shall be subjected to laboratory test at the option of the Contractor. If the test results show that the materials could be treated or blended to produce materials of the required quality for incorporation into the Works, the Contractor may perform such treatment or blending operations to the complete satisfaction of the Engineer. In all cases, the Contractor, in electing to undertake the testing and treatment/blending operations, shall not be entitled to extension of time or additional compensation.

Where excavation to the finished graded section results in a subgrade or slopes of unsuitable soil, the Engineer may require the Contractor to remove the unsuitable material and backfill to the finished graded section with approved material. The Contractor shall conduct his operations in such a way that the Engineer can take necessary cross-sectional measurements before the backfill is placed.

When any material including surplus or unsuitable materials from excavations are to be disposed off outside the right-of-way, the Contractor shall first obtain a written permission from the property owner of the proposed disposal site. The Contractor shall submit to the Engineer a certified copy of the written permission together with a written release of responsibility by the property owner absolving the government from any responsibility in connection with the disposal of material at the sites. The disposal of materials at the site as provided shall be made in a neat and uniform manner and the disposal site must be approved by the Engineer.

102.3 Method of Measurement

The cost of excavation of material, which is incorporated in the Works or in other areas utilized as fill, shall be deemed included in the Items of Works where the material is used. The measurement of Unsuitable or Surplus material shall be the net volume in its original position.

For measurement purposes, surplus suitable material shall be calculated as the difference between the net volume of suitable material required to be used in embankment, corrected by applying a shrinkage factor or a swell factor in case of rock excavation, determined by the laboratory tests to get its original volume measurement, and the net volume of suitable material from excavation in the original position. Separate pay items shall be provided for surplus common, unclassified and rock material.

The Contractor shall be deemed to have included in the contract unit prices all costs of obtaining land for the disposal of unsuitable or surplus material.

102.4 Basis of Payment

The accepted quantities, measured as prescribed in Section 102.3 shall be paid for in the contract unit price for each of the Pay Items listed below that is included in the Bill of Quantities which price and payment shall be full compensation for the removal and disposal of excavated materials including all labor, equipment, tools and incidentals necessary to complete the work prescribed in this Item.

Payment will be made under:

Pay Item Number	Description	Unit of Measurement
102(2)	Roadway Surplus Common Excavation	Cubic Meter

ITEM 103 STRUCTURE EXCAVATION**103.1 Description**

This item shall consist of the necessary excavation for foundation of bridges, culverts, underdrains, and other structures not otherwise provided for in the Specifications. Except as otherwise provided for pipe culverts, the backfilling of completed structures and the disposal of all excavated surplus materials, shall be in accordance with these Specifications and in reasonably close conformity with the Plans or as established by the Engineer.

This item shall include necessary diverting of live streams, bailing, pumping, draining, sheeting, bracing, and the necessary construction of cribs and cofferdams, and furnishing the materials therefore, and the subsequent removal of cribs and cofferdams and the placing of all necessary backfill.

Structure excavation shall also include the furnishing and placing of approved foundation fill material to replace unsuitable materials encountered below the foundation elevations of the structures.

103.2 Construction Requirements**103.2.1 Clearing and Grubbing**

Prior to starting excavation operations in any area, all necessary clearing and grubbing in that's area shall have been performed in accordance with Item 100. Clearing and Grubbing.

103.2.2 Excavation

Generally, in all structures, the Contractor shall notify the Engineer sufficiently in advance of the beginning of any excavation so that cross-sectional elevations and measurements may be taken on the undisturbed ground. The natural ground adjacent to the structure shall not be disturbed without permission of the Engineer.

Any excavation carried beyond the limits and dimensions as shown or described on the Drawings or Specifications shall be backfilled with acceptable materials.

Trenches or foundation pits for structures or structure footings shall be excavated to the lines and grades or elevation shown on the Plans or as staked by the Engineer. They shall be of sufficient size to permit the placing of structures or structure footings of the full width and length as shown on the Plans. The elevations of the bottoms of footings, as shown on the Plans, shall be considered as approximate only and the Engineer may order, in writing, such changes in dimensions or elevations of footings as maybe deemed necessary, to secure a satisfactory foundation.

If excess excavation occur which resulted to a greater depth or width than is necessary, then the Contractor shall at his own expense backfill the excess excavation with approved materials, compacted to the density of the adjacent ground, to the correct levels and dimensions to the approval of the Engineer.

When instructed by the Engineer, the Contractor shall carefully set aside the various materials encountered so that they may be replaced in their original position

Trenches shall be kept clean and free from water during excavation, concreting, laying of pipes and backfilling. In cases where presence of water is unavoidable during excavation and prior the laying of pipes, the Contractor shall dig diversion channels, erect cofferdams or otherwise de-water the trench to ensure proper procedure and compaction before concreting or laying of pipes.

Where, in the opinion of the Engineer, any invert has become soft or unsuitable to receive the culvert or concrete bed due to the Contractor's method of working, the Contractor shall at his own expense remove and replace the material with non-structural concrete or other approved material as instructed by the Engineer. Where concrete is specified, the mix shall consist of ordinary portland cement and aggregate, both complying with the Specifications Item 405. The weight of cement mixed with 0.3m³ of aggregate shall not be less than 50 kg. The quantity of water shall not exceed that required to produce a smooth cement paste, which coat evenly the whole of the aggregate.

For pipe culverts, the width of the pipe trench shall be sufficient to permit satisfactory jointing of the pipe and thorough tamping of the bedding material under and around the pipe.

Where rock, hardpan, or other unyielding material is encountered, it shall be removed below the foundation grade for a depth of at least 300mm or 4mm for each 100mm of fill over the top of pipe, whichever is greater, but not to exceed three-quarters of the vertical inside diameter of the pipe. The width of the excavation shall be at least 300mm greater than the horizontal outside diameter of the pipe. The excavation below grade shall be backfilled with selected fine compressible material, such as silty clay or loam, and lightly compacted in layers not over 150mm in uncompacted depth to form a uniform but yielding foundation.

For culverts which are to be constructed under a “trenched” or “negative projection” conditions, where the pipes are laid in a trench excavated below existing ground level or in a trench excavated in a previously constructed embankment, the top 150mm in the trench invert shall be compacted to a dry density of at least 95% MDD (AASHTO T99) or at least the same density as the adjacent ground, whichever is the greater, unless otherwise specified.

Where culverts are to be laid under the “embankment” or “positive projection” conditions, the Contractor shall level the existing ground by excavating and backfilling. The Contractor shall then compact the ground for 150 mm below invert or underside of bedding material to a dry density of 95% MDD (AASHTO T99) or to the density of the adjacent ground, whichever is the greater, such that the foundation of the culvert or bedding is true to grade and of uniform density over the whole length of the culvert.

The Engineer’s approval is required before placing concrete in all excavations for structures made through water bearing strata that require dewatering.

103.2.3 Utilization of Excavated Materials

All suitable excavated materials shall be utilized as backfill or embankment. The surplus materials shall be disposed off in such manner as not to obstruct the stream or otherwise impair the efficiency or appearance of the structure. No excavated materials shall be deposited at any time so as not to endanger the partly finished structure.

103.2.4 Cofferdams

Suitable and practically watertight cofferdams shall be used wherever water-bearing strata are encountered above the elevation of the bottom of the excavation. The Contractor shall submit the drawings showing his proposed method of cofferdam construction, as directed by the Engineer.

103.2.5 Preservation of Channel

Unless otherwise permitted, no excavation shall be made outside of caissons, cribs, cofferdams, or sheet piling and the natural streambed adjacent to structure shall not be disturbed without the permission from the Engineer. If any excavation or dredging is made at the side of the structure before the caissons, cribs, or cofferdams are sunk in place, the Contractor shall, after the foundation base is in place, backfill all such excavations to the original ground surface or stream bed with material satisfactory to the Engineer.

103.2.6 Backfill and Embankment for Structures Other than Pipe Culvert

Excavated areas around structures shall be backfilled with free draining granular materials approved by the Engineer and placed in horizontal layers not over 150mm in thickness, to the level of the

original ground surface. Each layer shall be moistened or dried as required and thoroughly compacted with mechanical tampers.

Backfill and embankment for structures other than pipe culverts shall be of suitable common materials excavated from required excavation or from borrow source.

103.2.7 Bedding, Backfill, and Embankment for Pipe Culverts

Bedding, Backfill and Embankment for Pipe Culverts shall be done in accordance with Item 500, Pipe Culverts and Storm Drains.

103.2.8 Choring, Cribbing, and Related Work

Shoring, cribbing, and related protective works if required in the construction shall not be measured and paid for separately and shall be considered subsidiary to the item for which they are constructed and utilized.

103.3 Method of Measurement

103.3.1 Structure Excavation

The volume of excavation to be paid for will be the number of cubic meters measured in original position of material acceptably excavated in conformity with the Plans or as directed by the Engineer, except as noted, will any of the following volumes be included in the measurement for payment:

- (1) The volume outside the vertical planes 450mm outside of the parallel to the neat lines of footings and the inside walls of the pipe and pipe-arch culverts at the widest horizontal dimensions.
- (2) The volume of excavation for culvert and section outside the vertical plane for culverts stipulated in (1) above.
- (3) The volume outside of the neat lines of underdrains as shown on the Plans and outside the limits of foundation fill as ordered by the Engineer.
- (4) The volume included within the staked limits of the roadway excavation, contiguous channel changes, ditches, etc., for which payment is otherwise provided in the Specification.
- (5) Volume of water or other liquid resulting from construction operations and which can be pumped or drained away.
- (6) The volume of any excavation performed prior to the taking of elevations and measurements of the undisturbed ground.
- (7) The volume of any material rehandled, except that where the Plans indicate or the Engineer directs the excavation after embankment has been placed and except that when installation of pipe culverts by the imperfect trench method

specified in Item 500 is required, the volume of material re-excavated as directed will be included.

- (8) The volume of excavation for footings ordered at a depth of more than 1.5m below the lowest elevation for such footings shown on the original Contract Plans for individual footings.

103.3.2 Bridge Excavation

The volume of excavation, designated on the Plans or in the Special Provisions, as "Bridge Excavation" will be measured as described below and will be kept separately from the excavation for all structures for payment purposes.

The volume of bridge excavation to be paid shall be the vertical 450mm outside of and parallel to the neat lines of the footing. The vertical planes shall constitute the vertical faces of the volume for pay quantities regardless of excavation inside or outside of these planes.

103.3.3 Foundation Fill

The volume of foundation fill to be paid for will be the number of cubic meters measured in final position of the special granular material actually provided and placed below the foundation elevation of the structures as specified, completed in place and accepted by the Engineer.

103.3.4 Shoring, Cribbing, and Related Work

Shoring, cribbing and related work whenever included as a pay item in the Bill of Quantities will be paid for at a lump sum bid price. This work shall include furnishing, constructing, maintaining and removing any and all shoring, cribbing, cofferdams, caissons, bracing, sheeting, water control, and other operations necessary for the acceptable completion of excavation included in the work of this Section, to a depth of 1.5m below the lowest elevation shown on the Plans for each separable foundation structure.

103.4 Basis of Payment

The accepted quantities, measured as prescribed in Section 103.3, shall be paid for in the Contract unit price for each of the particular pay items listed below that is included in the Bill of Quantities.

The payment for structure excavation and bridge excavation shall be deemed to include the cost of backfilling, shoring, cribbing, protective works, removing and disposing unsuitable materials off site and removal and hauling of excess suitable materials to stockpiles as directed by the Engineer. The payment shall be the full compensation for the work item including the cost of labor, equipment, tools and incidentals necessary to complete the work prescribed in this item.

No measurement for separate payment to the Contractor shall be made for backfill being the relevant compensation included by the Contractor in his rates in the Bill of Quantities in the pay items for excavation for structures and bridges.

Payment will be made under:

Pay Item Number	Description	Unit of Measurement
103(1)a	Structure Excavation (Streetlight Concrete Pedestal)	Cubic Meter
103(2)a	Bridge Excavation (Common Soil)	Cubic Meter
103(3)	Foundation Fill	Cubic Meter
103(6)a	Structure Excavation (Pipe Culverts and Drain Excavation)	Cubic Meter

ITEM 104 EMBANKMENT

104.1 Description

This item shall consist of the construction of embankment in accordance with this Specification and in conformity with the lines, grades and dimensions shown on the Plans or established by the Engineer.

104.2 Material Requirements

Embankment shall be constructed of suitable materials in accordance with the following definition:

1. Suitable Material

Material which is acceptable in accordance with the contract and which can be compacted in the manner specified in this Item. It can be common material or rock provided however, it shall have a CBR value of not less than seven (7%) percent when tested according to AASHTO 193-81 after four days soaking when compacted to 95% of the maximum dry density according to AASHTO T-99-90.

Selected Borrow, for topping - shall be soil of such gradation that all particles will pass a sieve with 75 mm (3 inches) square openings and not more than 15 mass percent will pass the 0.075 mm (No. 200) sieve, as determined by AASHTO T 11. The material shall have a plasticity index ranging from 6% -11% as determined by AASHTO T 90, a liquid limit of not more than 35 % as determined by AASHTO T 89.

2. Unsuitable Material - Material other than suitable materials such as:

- (a) Materials containing detrimental quantities of organic materials, such as grass, roots and sewerage.
- (b) Organic soils such as peat and muck.
- (c) Soils with liquid limit exceeding 80 and/or plasticity index exceeding 55.
- (d) Soils with natural water content exceeding 100%.
- (e) Soils with very low natural density, 800 kg/m³ or lower.

(f) Soils that cannot be properly compacted as determined by the Engineer.

3. Selected Granular Embankment

In situations where placing and/or compaction under saturated or flooded conditions cannot be avoided, selected granular embankment shall be river run gravelly sand or gravel or other clean granular materials as specified on the drawing or as directed and approved by the Engineer.

104.3 Construction Requirements

104.3.1 General

Prior to the construction of embankment, all necessary clearing and grubbing in that area shall have been performed in conformity with the item 100, Clearing and Grubbing.

The Contractor shall submit to the Engineer for review and approval the methodology he intends to apply for the formation of embankment satisfying all requirements. The methodology shall show the systematic procedure of constructing the embankment in conjunction with the procedure proposed for the slope protection as shown in the drawings.

The approval of the proposed methodology however does not relieve the Contractor of the responsibilities for any unsatisfactory or defective works as results of such methodology. The Engineer at his discretion may reject or require remedial measures to the defective works. The cost of replacing or remedying defective works shall be borne by the Contractor.

Embankment construction shall consist of formation of roadway embankments including preparation of the areas upon which they are to be placed; the construction of dikes within or adjacent to the roadway; the placing and compacting of approved material within the roadway areas where unsuitable material has been removed; and the placing and compacting of embankment material in holes, pits and other depressions within the roadway area.

Before embankment construction is started, the Contractor shall construct in accordance with his methodology, a section of trial embankment in accordance with Sub-section 104.3.3 Compaction Trials.

104.3.2 Method of Construction

In places where the road embankment will be constructed over the existing gravel or dirt road, as shown in the plan or as directed by the Engineer, the surface of the existing road shall be ripped to a depth of 150 mm. Then the existing road shall be reshaped and compacted to the same or greater density as the materials to be placed thereon, to provide a uniform foundation for the embankment materials to follow.

Thin bituminous layers less than 50 mm may be incorporated in the layer of the embankment.

In places where the road embankment will be constructed over the existing PCC pavement, the existing concrete pavement shall be broken into pieces with greatest dimensions of not more than 500 mm in accordance with the provisions of Sub-Section 105.3.6-Subgrade Preparation on Existing Pavement.

- Thin bituminous layers less than 50 mm may be incorporated in the layer of the embankment.
- In places where the road embankment will be constructed over the existing PCC pavement, the existing concrete pavement shall be broken into pieces with greatest dimensions of not more than 500 mm in accordance with the provisions of Sub-Section 105.3.6.
- 95% of maximum density as determined by AASHTO T 99, for all the embankment, except the top 300 mm (subgrade).
- 98% of the maximum density as determined by AASHTO T 180 for the top 300 mm (subgrade) of the embankment.

The embankment shall be compacted with compaction equipment over the full width and in a longitudinal direction until there is no visible movement of the rock fill materials when under the compacting equipment.

Placing of fill will be suspended if, in the opinion of the Engineer, there is no adequate compaction and grading equipment available on site in operating condition to shape and compact the fill immediately upon placement.

104.3.3 Compaction

Compaction Trials

1) General

Before starting the formation of embankments, the Contractor shall submit in writing to the Engineer for approval of his proposals for the compaction of each type of fill material to be used in the works. The proposals shall include the relationship between the types of compaction equipment, the number of passes required and the method of adjusting moisture content. The Contractor shall carry out full scale compaction trials on areas not less than 10m wide and 50 m long as required by the Engineer and using his proposed procedures or such amendments thereto as may be found necessary to satisfy the Engineer that all requirements regarding compaction can be consistently achieved. Compaction trials with the main types of fill material to be used in the works shall be completed before work with the corresponding materials will be allowed to commence.

All findings obtained from the trial compaction and tests shall be submitted to the Engineer for establishing desirable criteria for the quality control of the embankment works. The Contractor shall make joint efforts with the Engineer until acceptable criteria and methodology are established.

This compaction trial on trial embankments shall also include the Contractor's plan and schedule for the construction of the trial

embankment including location and area of embankment, type and quality of equipment, manner of blending, placing, spreading and compaction, items and quantity of test, and other information for the trial embankment.

No separate payment shall be made of the trial embankment, all the cost thereof are deemed to be included in the payment specified in this work item.

Throughout the periods when compaction of earthwork is in progress, the Contractor shall adhere to the compaction procedures found from compaction trials for each type of material being compacted, each type of compaction equipment employed and each degree of compaction specified.

2) Execution of Trial Embankment

The trial embankment shall be carried out simulating normal construction conditions by using all the equipment and methods proposed for placing, spreading and compaction the embankment materials.

The trial embankment shall be carried out at a minimum of four (4) independent sites, and the section of each trial embankment shall be constructed to the full width of the embankment over a 30m length and to a height of 0.6 m at least after compaction. Each trial embankment section shall be tested by various kind of compaction equipment.

Spreading depth of the trial embankment shall be not more than 20 cm after compaction.

The number of passes shall be varied to provide at least four (4) cases to establish a relation between number of passes and degree of compaction.

Several kinds of material, which can cover representative soil characteristics of the whole embankment materials, shall be tested. Should clearly different materials be used for a section of embankment, such materials shall also be tested in the same manner.

3) Soil Test and Measurement

All materials of embankment shall be conditioned beforehand and tested in accordance with Clause 104.2 of this Specification. The Contractor shall carry out, as a minimum, the following tests during the operation of the trial embankment:

a) Settlement measurement of layer.

Settlement of layer shall be measured after compaction at a minimum of nine (9) points per each trial in each site using a taut line horizontally strung between the batter boards at both ends of embankment.

- b) Measurement of in-place density and moisture content in accordance with Sub-Section 104.3.12 of this Specification. Measurement shall be made at a minimum of nine (9) points per each trial in each site.

4) Establishment of Criteria

The Contractor shall investigate results of the trial embankment and shall submit to the Engineer for approval his proposed method and manner of embankment operation which shall include full height construction of embankment, spreading depth, number of passes, type of equipment, combination of equipment, construction of slope protection, and other information necessary for establishing the criteria of embankment operation.

If acceptable criteria are not established, the Contractor shall repeat the trial embankment to the satisfaction of the Engineer.

104.3.4 Embankment Operation

a) General

This Sub-Section shall cover the manner of embankment construction, no separate payment shall be made for the requirements of this Sub-Section, and all the costs except surface preparation are deemed included in the payment specified in this work Item.

Costs of the surface preparation stated in the succeeding paragraph are deemed included in the related items of payment such as clearing and grubbing.

1) Operation of Borrow Pit

Borrow pits shall be cleared and grubbed as directed by the Engineer to remove all unsuitable materials. The Contractor shall, at his own expense secure the necessary right-of-way and access thereto and shall bear all royalty fees imposed by the owner and municipalities where these borrow areas are situated. The Contractor shall construct and maintain the haul roads, together with the necessary right-of-way for such roads .

Borrow pits where practicable shall be excavated to drain it to the nearest natural outlet or to such outlet as directed by the Engineer. The surface of the borrow pits shall be left in a reasonably smooth and even condition and then stripped top soil, if any, shall be returned and spread to the satisfaction of the Engineer before abandoning such borrow pit areas. Planting trees and grass of the leveled area may also be required from the Contractor before abandoning the borrow pit as directed by the Engineer.

2) Surface Preparation

Ground surface to be covered with embankment materials shall be prepared as follows:

- a) Clearing and grubbing shall be executed in accordance with the requirements specified in Item 100 of these Specifications.
- b) Stump holes or other small excavations in the limits of embankment shall be filled with embankment materials and thoroughly tamped by approved methods before commencing any of the embankment operation.
- c) The embankment operation shall be performed always in the dry condition. Springs and seepage along the foundation, if any, shall be treated by the method approved by the Engineer.
- d) Prior to placing of any fill upon the area, all clearing and grubbing operations and stripping of top soil, where required, shall have been completed.
- e) Where shown on the Drawings or ordered by the Engineer, the surface of the existing ground shall be compacted to the depth of 150 mm and in accordance with the requirements of Sub-section 104.3.3.

3) Excavation, Transportation and Stockpile

The Contractor shall excavate embankment materials at approved borrow pit, or at the stockpiles when the materials are stockpiled under the scope of the excavation works specified in Item 102, Excavation.

The material suitable for the embankment, which is, too wet for immediate compaction shall be placed temporarily to the stockyard and aerated until the moisture content is sufficiently reduced to permit them for the embankment operation.

4) Placing, Spreading and Compaction

Placing spreading and compaction of embankment materials shall be executed in the manner of the approved criteria of embankment operation established through the trial embankment. Materials shall be placed and spread so that no single layer exceeds 200 mm in thickness after compaction. As far as practicable, the material shall be dried or wetted to have proper moisture content within the allowable range determined through the regular compaction test.

Equipment for placing, spreading and compaction shall be as specified in the approved criteria of embankment operation. No other equipment shall be used without the approval of the Engineer.

Degree of compaction shall be as specified in Sub-Section 104.3.3. When any layer fails to comply with the specified degree of compaction, the Contractor shall immediately re-compact, wet or dry, improve or replace the materials. All soft or yielding areas that may develop in the embankment shall be corrected by re-compaction, by removing the unsuitable materials and replacing them immediately upon order of the Engineer.

When the results of embankment monitoring show the possibility of slope or embankment failure, the Contractor shall take immediate action such as tentative removal of a part of embankment, tentative counterweight fill, or any other measures, which the Contractor deems necessary. The Contractor shall in this case, notify the Engineer of such possibility and the measures being promptly taken by the Contractor to the extent possible.

5) Tolerance

The completed embankment section shall have elevation and dimensions which fall within the following tolerances.

Elevation/Dimension	Tolerance (mm)
Crest Elevation of Embankment	± 50
Crest Width of Embankment	± 100
Length of Embankment Slope	± 200

104.3.5 Quality Control of Embankment Operation

1) General

Quality control of the embankment operation shall be carried out through the regular compaction test and the daily control test as specified hereinafter.

No separate payment shall be made for the requirements of this Sub-Section and all the costs thereof are deemed included in the payment specified in this work item.

2) Regular Compaction Test

The regular compaction test shall be carried out once every 20,000 m³ of the materials before compaction in accordance with JIS-A-1210 and before a new source of material is placed in the works. Measurement of natural moisture content and specific gravity of soils and determination of the optimum moisture content and the maximum dry density shall be made and results shall be submitted to the Engineer for approval.

3) Daily Quality Control Test

a) General

Daily quality control test shall be executed at embankment sites by use of the radioisotope type soil density and moisture gauge (RI gauge) which shall be procured by the Contractor.

The Contractor shall measure in-place dry density and in-place moisture content using the RI gauge on daily basis when the embankment operation is executed.

b) Execution of Daily Quality Control Test

Measurement of in-place dry density and in-place moisture content shall be made daily at the rate of one (1) point measurement per 500 square meter area of each layer of compacted fill.

All measurement data shall be recorded and filed with direct output from the RI gauge. Record format shall contain, but not limited to, the following items.

- Date and time of measurement
- Weather condition
- Rainfall
- Location of Embankment
- Location of Measurement
- Approximate work volume of embankment
- Type of embankment material.
- Moisture content at borrow pit or stockyard
- In-place moisture content at embankment site
- In-place density of embankment material
- Degree of compaction
- Presence of the Engineer

The Contractor shall plot the data in a form of daily control graph and shall monitor its daily change.

The Contractor shall submit all the test results of daily quality control test to the Engineer once every week for approval.

The Contractor, when requested by the Engineer, shall measure in-place density of the soils by the sand replacement method in a manner specified in JIS-A -1214 or ASTM equivalent.

104.3.6 Protection of Roadbed during Construction

During the construction of the roadway, the roadbed shall be maintained in such condition that it will be well drained at all times. Side ditches or gutters emptying from cuts to embankments or otherwise shall be so constructed as to avoid damage to embankments by erosion.

104.3.7 Protection of Structures

If embankment can be deposited on one-side only of abutments, wing walls, piers or culvert headwalls, care shall be taken that the area immediately adjacent to the structure is not compacted to the extent that it will cause overturning of, or excessive pressure against the structure. When noted on the Plans, the fill adjacent to the end bent of the bridge shall not be placed higher than the bottom of the

backfill of the bent until the superstructure is in place. When the embankment is to be placed on both sides of a concrete wall or box type structure, operations shall be so conducted that the embankment is always at approximately the same elevation on both sides of the structure.

104.3.8 Monitoring of Embankment

The settlement and stability of the major embankment formation shall be periodically monitored by the Contractor in accordance.

104.4 Method of Measurement

Any material coming from roadway, structure, drainage or ditch excavations which are suitable for use but are replaced by the Contractor with borrow materials without prior approval by the Engineer, shall not be measured for payment.

Measurement of quantities for embankment to be paid for shall be the volume of embankment materials placed and compacted in place to the lines, grades, and dimensions shown on the drawings or as directed by the Engineer and shall be taken only in the presence of the Engineer. The Engineer shall be notified at least 24 hours before taking such measurement. The volume of embankment materials shall be computed by end area method and determined from the execution section of the embankment established on the original ground line after stripping. The original ground line shall be surveyed and reported to the Engineer for checking and approval prior the execution of the embankment operation.

The quantity of Embankment from Borrow shall be calculated as the balance between the total embankment volume (as shown on the drawings plus volume due to settlement) and the total volume of suitable material from roadway excavation, from excess structure, bridge, pipe culvert and drainage excavation and from excess dredging and realignment of river channel excavation, employing the compaction factor 0.95 for common soil.

Materials from excavation per Item 102 and materials coming from dredging operation and realignment of river channel and structure excavation that is used in embankment formation and accepted by the Engineer will be paid under Embankment. Moreover, such payment will be deemed to include the cost of excavating, hauling, blending, drying and wetting if necessary, placing, spreading and compaction, stockpiling and all other costs incidental to the work.

Material for Selected Borrow topping will be measured and paid for under the same condition specified in the preceding paragraph.

104.5 Basis of Payment

The accepted quantities, measured as prescribed in Section 104.4, shall be paid for at the Contract unit price for each of the Pay Items listed below that is included in the Bill of Quantities. The payment shall continue full compensation for the furnishing, placing and compacting all materials, including all labor, equipment, tools and incidentals necessary to complete the work prescribed in this Item.

The unit price shall also include the costs for procurement and furnishing of required materials if not coming from approved excavation. No separate payment shall be made for the tentative removal of embankment, counterweight fill, placing and removal of surcharge and preload and secondary excavation and backfilling for structures to be constructed on the embankment, cost of which shall be deemed included in the unit price of the embankment.

Payment will be made under:

Pay Item Number	Description	Unit of Measurement
104 (1)a	Embankment from Roadway Excavation (Common Material)	Cubic Meter

ITEM 105 SUBGRADE PREPARATION

105.1 Description

This item shall consist of the preparation of the subgrade for the support of overlying structural layers. It shall extend to full width of the roadway. Unless authorized by the Engineer, subgrade preparation shall not be done unless the Contractor is able to start immediately the construction of the pavement structure.

105.2 Material Requirements

Unless otherwise stated in the Contract and except when the subgrade is in rock cut, all materials below subgrade level to a depth of 150mm or to such greater depth as may be specified shall meet the requirements of Section 104.2- Materials Requirement for Embankment

105.3 Construction Requirements

105.3.1 Prior Works

Prior to commencing preparation of the subgrade, all culverts, cross drains, ducts and the like (including their fully compacted backfill), ditches, drains and drainage outlets shall be completed. Any work on the preparation of the subgrade shall not be started unless prior work herein described shall have been approved by the Engineer.

105.3.2 Subgrade Level Tolerances

The finished compacted surface of the subgrade shall conform to the allowable tolerances as specified hereunder:

Permitted variation from	+	20 mm
design LEVEL OF SURFACE	-	30 mm
Permitted SURFACE IRREGULARITY MEASURED BY 3-m STRAIGHT EDGE		30 mm
Permitted variation from design CROSSFALL OR CAMBER	±	0.5 %

Permitted variation from
design LONGITUDINAL GRADE \pm 0.1 %
over 25 m length

105.3.3 Subgrade in Common Excavation

Unless otherwise specified, all materials below subgrade level in earth cuts to a depth of 150 mm or other depth shown on the Plans or as directed by the Engineer shall be excavated. The material, if suitable, shall be set aside for future use or, if unsuitable, shall be disposed of in accordance with the requirements of Sub-sections 102.2.9.

Where material has been removed from below subgrade level, the resulting surface shall be compacted to a depth of 150 mm and in accordance with the requirements of Sub-Section 104.3.3.

All materials immediately below subgrade level in earth cuts to a depth of 150 mm, or to such greater depth as may be specified, shall be compacted in accordance with the requirements of Subsection 104.3.3.

The roadbed material in cuts shall be moistened or dried to uniform moisture content within + or - 2% of optimum moisture and shall be thoroughly compacted.

- 95% of the maximum density as determined by AASHTO T 180 in case the roadbed will constitute the subgrade of the new pavement.
- 100% of the maximum dry density as determined by AASHTO T 180, in case the roadbed will constitute the subbase of the new pavement

105.3.4 Subgrade in Rock Excavation

Surface irregularities under the subgrade level remaining after trimming of the rock excavation shall be leveled by placing specified material and compacted to the requirements of Subsection 104.3.3.

105.3.5 Subgrade on Embankment

After the embankment has been completed, the full width shall be conditioned by removing any soft or other unstable material that will not compacted properly. The resulting areas and all other low sections, holes or depressions shall be brought to grade with suitable material. The entire roadbed shall be shaped and compacted to the requirements of Subsection 104.3.3. Scarifying, blading, dragging, rolling or other method of work shall be performed or used as necessary to provide a thoroughly compacted roadbed shaped to the cross-sections shown on the Plans.

105.3.5 Subgrade on Existing Pavement

Where the new pavement is to be constructed immediately over an existing Portland Cement Pavement and if so specified in the Contract, the slab shall be broken into pieces with greatest dimension of not more than 500 mm and the existing pavement material compacted as specified in Subsection 104.3.3, as directed by the Engineer. The resulting subgrade level shall, as part of pavement construction be

shaped to conform to the allowable tolerances of Subsection 105.3.2 by placing and compacting where necessary a leveling course comprising the material of the pavement course to be placed immediately above.

Where the new pavement is to be constructed immediately over an existing Asphalt Concrete Pavement or gravel surface pavement and if so specified in the Contract, the pavement shall be scarified, thoroughly loosened, reshaped and recompactd in accordance with Subsection 104.3.3. The resulting subgrade level shall conform to the allowable tolerances if Subsection 105.3.2.

105.3.6 Protection of Completed Work

The Contractor shall be required to protect and maintain at his own expense the entire work within the limits of his Contract in good condition satisfactory to the Engineer from the time he first started work until all work shall have been completed. Maintenance shall include repairing and recompactd ruts, ridges, soft spots and deteriorated sections of the subgrade caused by the traffic of the Contractor's vehicle/equipment or that of the public.

105.3.7 Templates and Straightedges

The Contractor shall provide for use of the Engineer, approved templates and straightedges in sufficient number to check the accuracy of the work, as provided in this Specification.

105.4 Method of Measurement

105.4.1 Measurement of Items for payment shall be provided only for:

1. The compaction of existing ground below subgrade level in cuts of common material as specified in Subsection 105.3.3.
2. The breaking up or scarifying, loosening, reshaping and recompactd of existing pavement as specified in Subsection 105.3.6. The quantity to be paid for shall be the area of the work specified to be carried out and accepted by the Engineer.
3. The preparation of the subgrade at locations where unsuitable materials have been excavated and disposed shall be measured in square meters, which shall be calculated based on surveys carried out defining the limits as directed by the Engineer.
4. Should a leveling course be necessary to correct the irregularities of the prepared subgrade or for non-compliance to the maximum allowable tolerances prescribed in Section 105.3.5 such course shall not be measured separately and shall be deemed to have been included in the pay item for embankment.

105.5 Basis of Payment

Payment will be made under:

Pay Item Number	Description	Unit of Measurement
105 (1)a	Subgrade Preparation (Common Material)	Square Meter

PART D

SUBBASE AND BASE COURSE

PART D SUBBASE AND BASE COURSE

ITEM 200 AGGREGATE SUBBASE COURSE

200.1 Description

This item shall consist of furnishing, placing and compacting an aggregate subbase course on a prepared subgrade in accordance with this Specification and the lines, grades and cross-sections shown on the plans, or as directed by the Engineer.

200.2 Material Requirements

Aggregate for subbase shall consist of hard, durable particles or fragment crushed stone, crushed slag, or crushed or natural gravel and filler of natural or crushed sand or other finely divided mineral matter. The composite material shall be free from vegetable matter and lumps or balls of clay, and shall be of such nature that it can be compacted readily to form a firm, stable subbase.

The subbase material shall conform to Table 200.1, Grading Requirements

Table 200.1 – Grading Requirements

Sieve Designation		Mass Percent Passing
Standard, mm	Alternate US Standard	
50	2"	100
25	1"	55 – 85
9.5	3/8"	40 – 75
0.075	No. 200	0 – 12

The fraction passing the 0.075 mm (No.200) sieve shall not be greater than 0.66 (two thirds) of the fraction passing the 0.425 mm (No. 40) sieve.

The fraction passing the 0.425 mm (No. 40) sieve shall have a liquid limit not greater than 35 and plasticity index not greater than 12 as determined by AASHTO T89 and T 90, respectively.

The coarse portion, retained on a 2.00 mm (No. 10) sieve, shall have a mass percent of wear not exceeding 50 by the Los Angeles Abrasion Tests as determined by AASHTO T 96.

The material shall have a soaked CBR value of not less than 30% as determined by AASHTO T 193. The CBR value shall be obtained at the maximum dry density and determined by AASHTO T 180, Method D.

200.3 Construction Requirements

200.3.1 Preparation of Existing Surface

The existing surface shall be graded and finished as provided under Item 105, Subgrade Preparation, before placing the subbase material.

200.3.2 Placing

The aggregate subbase material shall be placed at a uniform mixture on a prepared subgrade in a quantity which will provide the required compacted thickness. When more than one layer is required, each layer shall be shaped and compacted before the succeeding layer is placed.

The placing of material shall begin at the point designated by the Engineer. Placing shall be from equipment especially equipped to distribute the material in a continuous uniform layer or window. The layer or window shall be of such size that when spread and compacted the finished layer be in reasonably close conformity to the nominal thickness shown on the plans.

When hauling is done over previously placed material, hauling equipment shall be dispersed uniformly over the entire surface of the previously constructed layer, to minimize rutting or uneven compaction.

200.3.3 Spreading and Compacting

When uniformly mixed, the mixture shall be spread to the plan thickness, for compaction.

Where the required thickness is 150 mm or less, the material may be spread and compacted in one layer. Where the required thickness is more than 150 mm, the aggregate subbase shall be spread and compacted in two or more layers of approximately equal thickness, and the maximum compacted thickness of any layer shall not exceed 150 mm. All subsequent layers shall be spread and compacted in a similar manner.

The moisture content of subbase material shall, if necessary, be adjusted prior to compaction by watering with approved sprinklers mounted on trucks or by drying out, as required in order to attain the required compaction.

Immediately following final spreading and smoothing, each layer shall be compacted to the full width by means of approved compaction equipment. Rolling shall progress gradually from the sides to the center, parallel to the centerline of the road and shall continue until the whole surface has been rolled. Any irregularities or depressions that develop shall be corrected by loosening the material at these places and adding or removing material until surface is smooth and uniform. Along curbs, headers, and walls, and at all places not accessible to the roller, the subbase material shall be compacted thoroughly with approved tampers or compactors.

If the layer of subbase material, or part thereof, does not conform to the required finish, the Contractor shall at his own expense, make the necessary corrections.

Compaction of each layer shall continue until a field density of at least 100 percent of the maximum dry density determined in accordance with AASHTO T 180, method D has been achieved. In-place density determination shall be made in accordance with AASHTO T 191.

200.3.4 Trial Sections

Prior the subbase formation, the Contractor shall spread and compact trial sections as directed by the Engineer. The purpose of the trial sections is to check the suitability of the materials and the efficiency of the equipment and construction method, which is proposed to be used by the Contractor. Therefore, the Contractor must use the same material, equipment and procedures that he proposes to use for the main work. One trial section of about 500 m² shall be made for every type of material and/or construction equipment/procedure proposed for use.

After final compaction of each trial section, the Contractor shall carry out such field density tests and other tests required as directed by the Engineer.

If a trial section shows that the proposed materials, equipment or procedures in the Engineer's opinion are not suitable for subbase, the material shall be removed at the Contractor's expense, and a new trial section shall be constructed.

If the basic conditions regarding the type of material or procedure change during the execution of the work, new trial sections shall be constructed.

200.3.5 Tolerances

Aggregate subbase shall be spread with equipment that will provide a uniform layer which when compacted will conform to the designed level and transverse slope as shown on the plans. The allowable tolerances shall be as specified hereunder:

Permitted variation from design THICKNESS OF LAYER	± 20 mm
Permitted variation from design LEVEL OF SURFACE	+ 10 mm - 20 mm
Permitted SURFACE IRREGULARITY Measured by 3-m straight-edge	20 mm
Permitted variation from design CROSSFALL OR CAMBER	± 0.3%
Permitted variation from design LONGITUDINAL GRADE over 25 m in length	± 0.1%

200.4 Method of Measurement

Aggregate Subbase Course will be measured by the cubic meter (m³). The quantity to be paid for shall be the design volume compacted in-place as shown on the plans, and accepted in the completed course. No allowance will be given for materials placed outside the design limits shown on the cross-section. Trial

section shall not be measured separately but shall be included in the quantity of subbase herein measured.

200.5 Basis of Payment

The accepted quantities, measured as prescribed in Section 200.4, shall be paid for at the contract unit price for Aggregate Subbase Course which price and payment shall be full compensation for furnishings and placing all materials, including all labor, equipment, tools and incidentals necessary to complete the work prescribed in this Item.

Payment will be made under:

Pay Item Number	Description	Unit of Measurement
200(1)	Aggregate Subbase Course	Cubic Meter

ITEM 201 AGGREGATE BASE COURSE

201.1 Description

This Item shall consist of furnishing, placing and compacting an aggregate base course on a prepared subgrade/subbase in one or more layers in accordance with this Specification, and the lines, grades, thickness and typical cross – sections shown on the Plans or as established by the Engineer.

201.2 Material Requirements

Aggregate for base course shall consist of hard, durable particles or fragments of crushed stone, crushed slag, crushed or natural gravel, and filler of natural or crushed sand, other finely divided mineral matter. The composite material shall be free from vegetable matter and lumps or balls of clay, and shall be of such nature that it can be compacted readily to form a firm, stable base.

In some areas where the conventional base course materials are scarce or non-available, the use of 40% weathered limestone blended with 60% crushed stones or gravel shall be allowed, provided that the blended materials meet the requirements of this Item.

The base course material shall conform to Table 201.1, whichever is called for in the Bill of Quantities.

Table 201.1 – Grading Requirements

Sieve Designation		Mass percent Passing	
Standard, mm	Alternate US Standard	Grading A	Grading B
50	2"	100	
37.5	1-1/2"	-	100
25	1"	60 – 85	-
19	3/4"	-	60 – 85
12.5	1/2"	35 – 65	-
4.75	No. 4	20 – 50	30 – 55
0.425	No. 40	5 – 20	8 – 25
0.075	No. 200	0 – 12	2 – 12

The fraction of the material passing the 0.075 mm (No. 200) sieve shall not be greater than 0.66 (two thirds) of the fraction passing the 0.425 mm (No. 40) sieve.

The fraction of the material passing the 0.425 mm (No. 40) sieve shall have a liquid limit of not more than 25 and a plasticity index of not more than 6 as determined by AASHTO T 89 and T 90, respectively.

The coarse portion retained on a 2.00 mm (No. 10) sieve shall have a mass percent of wear not exceeding 50 by the Los Angeles Abrasion Test as determined by AASHTO T 96.

The material passing the 19mm sieve shall have a soaked CBR value of not less than 80% as determined by AASHTO T193. The CBR value shall be obtained at the maximum dry density (MDD) as determined by AASHTO 180. Method D.

If filler, in addition to that naturally present, is necessary for meeting the grading requirements or for satisfactory bonding, it shall be uniformly blended with the crushed base course material on the road or in a pug mill unless otherwise specified or approved by the Engineer. Filler shall be obtained from sources approved by the Engineer, free from hard lumps and shall not contain more than 15 percent of material retained on the 4.75 mm (No. 4) sieve.

201.3 Construction Requirements

201.3.1 Preparation of Existing Surface

The existing surface shall be graded and finished as provided under Item 105, Subgrade Preparation, before placing the base material.

201.3.2 Placing

It shall be in accordance with all the requirements of Subsection 200.3.2, Placing.

201.3.3 Spreading and Compacting

It shall be in accordance with all the requirements of Subsection 200.3.3, Spreading and Compacting.

201.3.4 Trial Sections

Trial sections shall conform in all respects to the requirements specified in Subsection 200.3.4.

201.3.5 Tolerances

The aggregate base course shall be laid to the designed level and transverse slopes shown on the Plans. The allowable tolerances shall be in accordance with following:

Permitted variation from design THICKNESS OF LAYER	± 10 mm
Permitted variation from design LEVEL OF SURFACE	+ 5 mm - 10 mm
Permitted SURFACE IRREGULARITY Measured by 3-m straight-edge	5 mm
Permitted variation from design CROSSFALL OR CAMBER	± 0.2%
Permitted variation from design LONGITUDINAL GRADE over 25 m in length	± 0.1%

201.4 Method of Measurement

Aggregate Base Course will be measured by the cubic meter (m³). The quantity to be paid for shall be the design volume compacted in-place as shown on the Plans, and accepted in the completed base course. No allowance shall be given for materials placed outside the design limits shown on the cross-sections. Trial sections shall not be measured separately but shall be included in the quantity of aggregate base course.

201.5 Basis of Payment

The accepted quantities, measured as prescribed in Section 201.4, shall be paid for at the contract unit price for Aggregate Base Course which price and payment shall be full compensation for furnishing and placing all materials, including all labor, equipment, tools and incidentals necessary to complete the work prescribed in this Item.

Payment will be made under:

Pay Item Number	Description	Unit of Measurement
201	Aggregate Base Course	Cubic Meter

ITEM 202 CRUSHED AGGREGATE BASE COURSE

202.1 Description

This Item shall consist of furnishing, placing and compacting crushed gravel, crushed stone or crushed rock on a prepared subgrade/subbase in one or more layers in accordance with this Specification, and the lines, grades, thickness and typical cross – sections shown on the Plans or a as established by the Engineer.

202.2 Material Requirements

202.2.1 Crushed Aggregate

It shall consist of hard, durable particles or fragments of stone or gravel crushed to the size and of the quality requirements of this Item.

It shall be clean and free from vegetable matters, lumps or balls of clay and other deleterious substances. The material shall be of such nature that it can be compacted readily to form a firm, stable base.

The base material shall conform to the grading requirements of Table 202.1, whichever is called for in the Bill of Quantities.

Table 201.1 – Grading Requirements

Sieve Designation		Mass percent Passing	
Standard, mm	Alternate US Standard	Grading A	Grading B
37.5	1-1/2"	100	
25	1"	-	100
19	3/4"	60 – 85	-
12.5	1/2"	-	60 – 90
4.75	No. 4	30 – 55	30 – 65
0.425	No. 40	5 – 20	10 – 30
0.075	No. 200	2 – 14	5 – 15

The portion of the material passing the 0.075 mm (No. 200) sieve shall not be greater than 0.66 (two thirds) of the fraction passing the 0.425 mm (No. 40) sieve.

The portion of the material passing the 0.425 mm (No. 40) sieve shall have a liquid limit of not more than 25 and a plasticity index of not more than 6 as determined by AASHTO T 89 and T 90, respectively.

The coarse aggregate retained on a 2.00 mm (No. 10) sieve shall have a mass percent of wear not exceeding 45 by the Los Angeles Abrasion Test as determined by AASHTO T 96, and not less than 50 mass percent shall have at least one (1) fractured face.

The material passing the 19 mm sieve shall have a minimum soaked CBR value of 80% tested according to AASHTO T 193. The CBR value shall be obtained at the maximum dry density (MDD) as determined by AASHTO T 180, Method D.

If filler, in addition to that naturally present, is necessary for meeting the grading requirements or for satisfactory bonding, it shall be uniformly blended with the crushed base course material on the road or in a pug mill unless otherwise specified or approved. Filler shall be obtained from sources approved by the Engineer, free from hard lumps and shall not contain more than 15 percent of material retained on the 4.75 mm (No. 4) sieve.

202.3 Construction Requirements

202.3.1 Preparation of Existing Surface

The existing surface shall be graded and finished as provided under Item 105- Subgrade Preparation and Item 200- Aggregate Subbase Course before placing the base material.

202.3.2 Placing

The aggregate base course material shall be placed at a uniform mixture on a prepared subbase in a quantity, which will provide the required compacted thickness. When more than one layer is required, each layer shall be shape and compacted before the succeeding layer is placed.

The placing of material shall begin at the point designated by the Engineer. Placing shall be from vehicles especially equipped to distribute the material in a continuous uniform layer or windrow. The layer or windrow shall be of such size that when spread and compacted, the finished layer shall be in reasonably close conformity to the nominal thickness shown on the Plans.

When hauling is done over previously place material, hauling equipment shall be dispersed uniformly over the entire surface of the previously constructed layer, to minimize rutting or uneven compaction.

202.3.3 Spreading and Compacting

When uniformly mixed, the mixture shall be spread to the plan thickness, for compaction.

Where the required thickness is 150 mm or less, the material may be spread and compacted in one layer. Where the required thickness is more than 150 mm, the aggregate base course shall be spread and compacted in two or more layers of approximately equal thickness, and the maximum compacted thickness of any layer shall not exceed 150 mm. All subsequent layers shall be spread and compacted in a similar manner.

Immediately following final spreading, each layer shall be compacted to the full width by means of approved compaction equipment. Rolling shall progress gradually from the side to the center, parallel to the centerline of the road and shall continue until the whole surface has been rolled. Any irregularities or depression that develop shall be corrected by loosening the material at these places and adding or removing material until surface is uniform.

If the layer of base course material, or part thereof, does not conform to the required finish, the Contractor shall, at his own expense, make the necessary corrections.

202.4 Method of Measurement

Crushed Aggregate Base Course will be measured by the cubic meter (m³). The quantity to be paid for shall be the design volume compacted in-place as shown on the Plans, and accepted in the completed course. No allowance shall be given for materials placed outside the design limits shown on the cross-sections. Trial sections shall not be measured separately but shall be included in the quantity of crushed aggregate base course.

202.5 Basis of Payment

The accepted quantities, measured as prescribed in Section 202.4, shall be paid for at the contract unit price for Crushed Aggregate Base Course which price and payment shall be full compensation for furnishing and placing all materials, including all labor, equipment, tools and incidentals necessary to complete the work prescribed in this Item.

Payment will be made under:

Pay Item Number	Description	Unit of Measurement
202 (1)	Crushed Aggregate Base Course	Cubic Meter

PART E

SURFACE COURSES

PART E SURFACE COURSES**ITEM 301 BITUMINOUS PRIME COAT****301.1 Description**

This Item shall consist of preparing and treating an aggregate base course with material in accordance with the Plan and Specifications, preparatory to the construction of a bituminous surface course.

301.2 Material Requirements

Bituminous material shall be either Rapid Curing (RC) or Medium Curing (MC) Cut-back Asphalt, whichever is called for in the Bill of Quantities. It shall conform to the requirements of Item 702, Bituminous Materials. The type and grade shall be specified in the Special Provision.

301.3 Construction Requirements**301.3.1 Surface Condition**

Prime coat shall be applied only to surfaces which are dry or slightly moist. No prime coat shall be applied when the weather is foggy or rainy.

301.3.2 Equipment

The liquid bituminous material shall be sprayed by means of a pressure distributor or not less than 1000 liters capacity, mounted on pneumatic tires of such width and number that the load produced on the road surface will not exceed 1 kN(100kgf) per cm width of tire.

The tank shall have a heating device able to heat a complete charge of bituminous liquid to 180 °C. The heating device shall be such that overheating will not occur. Consequently, the flames must not directly touch the casing of the tank containing the bituminous liquid. The liquid shall be insulated in such a way that the drop in temperature when the tank is filled with bituminous liquid at 180 °C and not heated will be less than 2 °C per hour. A thermometer shall be fixed to the tank in order to be able to measure continuously the temperature of the liquid. The thermometer shall be placed in such a way that the highest temperature in tank is measured. The tank shall be furnished with a calibrated dipstick to indicate the contents. The pipes for filling the tank shall be furnished with an easily changeable filter.

The distributor shall be able to vary the spray width of the bituminous liquid in maximum steps of 100 mm to a total width of 4 m. The spraying bar shall have nozzles from which the liquid is sprayed fan-shaped on the road surface equally distributed over the total spraying width.

For application of the liquid bituminous material, the distributor shall have a pump either driven by a separate motor or with a device to synchronize its speed with the speed of the distributor. The pump shall be furnished with an indicator showing the rate of flow. The suction side of the pump shall have an easily changeable filter. A thermometer shall

be fixed, such that it indicates the temperature of the liquid immediately before it leaves the spraying bar.

The distributor shall be furnished with a tachometer, indicating its forward speed, which shall be visible from the driver's seat. The distributor shall be designed so that the deviation from the prescribed rate of application does not exceed 10% and shall be equipped with a device for hand spraying of the bituminous liquid.

301.3.3 Application of Bituminous Material

Immediately before applying the prime coat, the full width of surface to be treated shall be ensured to be free from all dirt and other objectionable materials. When required by the Engineer, immediately prior to the application of the prime coat, the surface shall be slightly sprayed with water but not saturated. Bituminous material shall be applied by means of a pressure distributor at the temperature given in Item 702, Bituminous Materials. The rate of application of the bituminous material shall be within the range of 1 to 2 liters/m². The exact application rate for the type of the bituminous material to be ordered by the engineer shall be based on the quality of the materials and the field condition.

The prime coat shall be left undisturbed for a period of at least 24 hours or until such time that it has sufficiently cured as determined by the Engineer, and shall not be opened to traffic so that it will not be picked up by the wheels of passing vehicles. The Contractor shall maintain the prime coat until the next course is applied. Care shall be taken that the application of bituminous material is not in excess of the specified amount. Any excess shall be blotted with sand or removed as directed by the Engineer. All areas inaccessible to the distributor shall be sprayed manually using the device for hand spraying. The surface of structures and trees adjacent to the areas being treated shall be protected in such a manner as to prevent their being spattered or marred.

301.4 Method of Measurement

Bituminous Prime Coat shall be measured by the area covered in square meter (m²).

301.5 Basis of Payment

The accepted quantity, measured as prescribed in Section 301.4, shall be paid for at the contract unit price for Bituminous Prime Coat which price and payment shall be full compensation for furnishing and placing all materials, including all labor, equipment, tools and incidentals necessary to complete this Item.

Payment will be made under:

Pay Item Number	Description	Unit of Measurement
301 (2)a	Bituminous Prime Coat RC, Cut-back Asphalt, Grade 70	Square Meters

ITEM 310 BITUMINOUS CONCRETE SURFACE COURSE, HOT-LAID**310.1 Description**

This Item shall consist of constructing a Bituminous Concrete Surface Course composed of aggregates, mineral filler, and bituminous material mixed in a central plant, constructed and laid hot on the prepared base in accordance with this Specification and in conformity with lines, grades, thickness and typical cross-section shown on the Plans.

310.2 Material Requirements**310.2.1 Composition and Quality of Bituminous Mixture (Job-Mix Formula)**

(Job-Mix Formula). The bituminous mixture shall be composed of aggregate, mineral filler, hydrated lime, and bituminous material.

At least three weeks prior to production, the Contractor shall submit in writing a job-mix formula for each mixture supported by laboratory test data along with samples and sources of the components and viscosity-temperature relationships information to the Engineer for testing and approval.

Each job-mix formula submitted shall propose definite single values for:

1. The percentage of aggregate passing each specified sieve size.
2. The percentage of bituminous material to be added.
3. The temperature of the mixture delivered on the road.
4. The kind and percentage of additive to be used.
5. The kind of mineral filler to be used.

After the job-mix is established, all mixture furnished for the project shall conform thereto within the following ranges of tolerances:

Passing No. 4 and larger sieves	± 7 percent
Passing No. 8 to No. 100 sieves (inclusive)	± 4 percent
Passing No. 200 sieve	± 2 percent
Bituminous Material	± 0.4 percent
Temperature of Mixture	± 10 ⁰ C

Should a change in source of material be proposed or should a job-mix formula prove unsatisfactory, a new job-mix formula shall be submitted by the Contractor in writing and be approved by the Engineer prior to production.

Approval of a new job-mix formula may require laboratory testing and verification.

The mixture shall have a minimum compressive strength of 1.4 MPa (200 psi).

The mixture shall have a mass percent air voids with the range of 3 to 5.

The mixture shall also have an index of retained strength of not less than 70 when tested by AASHTO T 165. For aggregates having maximum sizes over 25 mm (1 inch), AASHTO T 165 will be modified to use 150 mm x 150 mm (6 x 6 inches) cylindrical specimens. The 150 mm (6 inches) cylinders will be compacted by the procedures outlined in AASHTO T 167 modified to employ 10 repetitions of a molding load of 9.6 MPa (1400 psi), with no appreciable holding time after each application of the full load.

310.2.2 Bituminous Material

The kind of bituminous material to be used shall be Penetration Grade Asphalt Cement and shall it shall conform to the requirements of Item 702, Bituminous Materials. The grade of the bituminous material shall be specified in the Special Provisions.

310.2.3 Aggregates

Aggregates shall conform to the requirements. Coarse and fine aggregates shall be clean, hard, tough, sound particles free from decomposed material, vegetable matter and other deleterious substances.

Coarse aggregate shall consist of crushed rock or crushed river gravel. At least 50 percent by weight of the coarse aggregate retained on the 4.75 mm (No.4) sieve shall have at least one fractured face.

Fine aggregate, which is material passing a 4.75 (No.4) sieve, shall consist of sand or stone screenings or a mixture thereof. At least 50 percent by weight of the fine aggregates shall be angular or fractured particles.

The combined aggregate shall conform to Grading Class A as shown in Table 310.1. When the combined grading of the coarse and fine aggregate is deficient in material passing the No. 200 sieve, additional filler material shall be added. However, the grading shall be adjusted to take account of the results of the trials to allow the asphalt concrete mix to conform in all respects to the requirements for the specified job-mix.

Table 310.1 Aggregate Grading for Asphalt Concrete

Mix Class		Class A	Class B	Class C
Mix Use		Wearing, Binder	Wearing, Binder	Wearing
Min. Compacted Thickness		50 mm	35 mm	25 mm
U.S. Standard Sieve		Percent Passing by Weight		
mm	alternative			
25	(1 in)	100		
19	(3/4 in)	80 – 100	100	
12.5	(1/2 in)	-	80 – 100	100
9.5	(3/8 in)	60 – 80	70 – 90	80 – 100
4.75	(No. 4)	48 – 65	50 – 70	55 – 75
2.36	(No. 8)	35 – 50	35 – 50	35 – 50

0.600	(No. 30)	19 – 30	18 – 29	18 – 29
0.300	(No. 50)	13 – 23	13 – 23	13 – 23
0.150	(No. 100)	7 – 15	8 – 16	8 – 16
0.075	(No. 200)	1 – 8	4 – 10	4 – 10

Table 310.2 Filler Grading for Asphalt Concrete

U. S. Standard Sieve		Percent Passing by Weight
mm	Alternative	
0.600	(No. 30)	100
0.300	(No. 50)	95 – 100
0.075	(No. 100)	70 – 100

The coarse and fine aggregates shall meet the following requirements:

- a) The percentage of wear by the Los Angeles Abrasion Test (AASHTO T96) shall not be more than 40.
- b) The loss when subjected to five cycles of the Sodium Sulphate Soundness Test (AASHTO T104) shall be less than 12%.
- c) The Sand Equivalent (AASHTO T176) determined after all processing except for addition of asphalt cement shall not be less than 45.
- d) All aggregates shall be non-plastic.
- e) The flakiness index of the aggregate retained on the 9.5 mm (3/8 in) sieve when tested in accordance with BS812 shall not exceed 35%. (The flakiness index of an aggregate is the percentage by weight of particles in it whose least dimension (thickness) is less than three-fifths of their mean dimension. The test is not applicable to material passing a 6.3 mm (1/4 in) sieve.

310.2.4 Mineral Filler

Filler material shall consist of finely divided rock dust, hydrated lime, portland cement or other suitable mineral matter and shall conform to the grading shown in Table 310.2.

310.2.5 Hydrated Lime

Material to be used shall conform to Item 701, Construction Lime (Hydrated).

310.2.6 Proportioning of Mixtures

The proportion of bituminous material on the basis of total dry aggregate shall be from 5.0 to 8.0 mass percent. The exact percentage to be used shall be fixed by the Engineer in accordance with the job-mix formula and the other quality control requirements.

During the mixing operation, one-half to one (0.5 to 1.0) mass percent of hydrated lime, dry aggregate basis, shall be added to the mixture. The

lower percentage limit is applicable to aggregates which are predominantly calcareous.

The asphalt concrete mixture shall conform to requirements of Table 310.3. However, the exact composition of the mixture shall be adjusted to take account of the results of the mix trials to allow the asphalt concrete mix to conform in all respects to the requirements for asphalt concrete.

Table 310.3 Asphalt Cement Content of Asphalt Concrete Mix

% Asphalt Cement of Total Mix by Weight			
Binder Course		Wearing Course	
Minimum	Maximum	Minimum	Maximum
4.0	5.5	5.0	7.0

Marshall Specimens are to be obtained from each of the binder and wearing course materials supplied for trial laying purposes. The Marshall specimens shall be formed and compacted in proper molds, in accordance with the procedure described in ASTM D1599.

The Contractor shall demonstrate to the satisfaction of the Engineer, by testing, carried out in the presence of the Engineer, in accordance with the procedures set out in the Marshall Method of Mix Design in the Asphalt Institute Manual, Mix Design Methods for Asphalt Concrete and Other Hot Mix Types, Manual Series No. 2 (MS-2), that the requirements given in Table 310.4 are achieved. The loss in Marshall Stability by submerging specimens in water 60°C for 24 hours shall not be more than 25 percent of the stability of the job-mix. In addition, the Contractor shall demonstrate by approved tests, to the satisfaction of the Engineer that the proposed mix is not subject to stripping of the asphalt cement from the aggregates.

Table 310.4 Marshall Test Requirement for Asphalt Concrete

	Binder Course		Wearing Course	
	Min.	Max.	Min.	Max.
Stability (lbf)	1200	-	1200	-
Flow (0.01 in)	8	16	8	16
Air Voids (1%)	3	8	3	6
Aggregate Voids Filled with Asphalt Cement (%)	60	75	70	80
Field Compacted Density Marshall Specimen Density (%)	97	-	97	-

To determine the Marshall Specimen Density, for each set of six Marshall Specimens, the highest and lowest densities shall be ignored and the Marshall Specimen Density shall then be the mean of the densities of the remaining four specimens.

As compacted densities shall be determined of samples taken from the materials laid and compacted for the mix trials as specified, at least four samples shall be taken for each of the binder and wearing course materials, under the direction of the Engineer and the required percentage of the Marshall Specimen Density shall be achieved in each case. Testing shall be in accordance with ASTM D1188 or ASTM D2726.

When the Engineer is satisfied that the materials and methods demonstrated by the Contractor during the trial laying comply with the requirements of the Contract, the Engineer shall determine the job-mix and shall inform the Contractor in writing of its composition. On receipt of such information, the Contractor may proceed with the work.

310.3 Construction Requirements

310.3.1 Spreading and Finishing

The mixture shall be spread and stuck off to the grade and elevation established. Bituminous pavers shall be used to distribute the mixture either over the entire width or over such partial width as may be practicable and approved by the Engineer.

Asphalt pavers (asphalt finisher) shall be equipped with automatic systems of control and screed for both longitudinal grade and cross-slope. The automatic system may be purchased in kit form and locally installed or be a factory-installed item. The control system may be a pneumatic-hydraulic or electric-hydraulic type actuated by slope sensors and a 9-meter grade reference.

310.3.2 Surface Tolerances

The allowable tolerances for the flexible surfacing and cement concrete pavement are given in Table 310.5.

Table 310.5 Tolerances for Flexible Surfacing and Cement Concrete Pavement

	ASPHALT CONCRETE SURFACING (Binding & Wearing Courses)	CEMENT CONCRETE PAVEMENT	BITUMINOUS SURFACE TREATMENT	GRAVEL SURFACING
Permitted variation from design THICKNESS OF LAYER mm	- +5	+5	-5	-5
Permitted variation from design LEVEL OF SURFACE mm	+5	+5	-5	-5
Permitted SURFACE IRREGULARITY Measured by 3m Straight-edge mm	5	5	5	5
PERMITTED				
Permitted variation from design CROSSFALL OR %	±0.2	±0.2	±0.2	±0.2

CAMBER				
--------	--	--	--	--

310.4 Method of Measurement

The area to be paid for under this Item shall be the number of square meters (m²) of asphalt pavement placed, compacted and accepted based on the thickness and density of the cores taken in accordance with Subsection 307.3.10 (Acceptance, Sampling and Testing).

**Item 307- Bituminous Plant-Mix Surface Course-General
Subsection 307.3.10 - Acceptance, Sampling and Testing**

The contractor shall cut full depth samples as directed, from the finished pavement, for testing. Samples shall be neatly cut by saw or core drill. Each sample shall be at least 150 mm x 150 mm or 100 mm diameter full depth. At least one, but not more than three samples shall be taken for each full day's operation. If no core samples were taken during the day's operation, core samples shall be taken from the completed pavement for every 100 L.M. per lane. The contractor shall supply and furnish new material to backfill boreholes left by the samples taken.

No acceptance and final payment shall be made on completed asphalt pavement unless core test for thickness determination is conducted, except for Barangay Roads where the implementing office is allowed to waive such test.

The samples obtained will be used to measure the thickness of the pavement. The same samples will be used to test the density of the compacted pavement by AASHTO T 166.

The compacted pavement shall have a density equal to, or greater than 97 mass percent of the density of a laboratory specimen. The asphalt pavement represented by the cores shall not be accepted if the deficiency in density is more than 2%.

The compacted pavement shall have a thickness tolerances of -5 mm. Thickness in excess of the specified thickness shall not be considered in the payment of asphalt pavement. The asphalt pavement represented by the individual core shall not be accepted if the deficiency in the core thickness as obtained in accordance with ASTM D 3549 is more than 5 mm. Averaging of the density and thickness of asphalt cores is not permitted.

If the deficiency in the core thickness is more than 5 mm, additional layer may be permitted in order to meet the designed thickness, however, the minimum additional asphalt overlay thickness should be dependent on the minimum thickness capacity of asphalt paver but it should not be less than 50 mm (2 inches) and that proper construction procedures are followed.

310.5 Basis of Payment

The accepted quantity, measured as prescribed in section 310.4, shall be paid for at the contract unit price for Bituminous Concrete Surface Course, Hot-Laid, which price and payment shall be full compensation for furnishing all materials,

handling, mixing, hauling, placing, rolling, compacting, labor, equipment, tools and incidentals necessary to complete this Item.

Payment will be made under:

Pay Item Number	Description	Unit of Measurement
310 (1)a3	Bituminous Concrete Surface Course (Wearing), Hot-Laid, 30mm thick	Square Meter

ITEM 311 PORTLAND CEMENT CONCRETE PAVEMENT

311.1 Description

This Item shall consist of pavement of Portland Cement Concrete, with or without reinforcement, constructed on the prepared base in accordance with this Specification and in conformity with lines, grades, thickness and typical cross-section shown on the Plans.

311.2 Material Requirements

311.2.1 Portland Cement

It shall conform to the applicable requirements of Item 700, Hydraulic Cement. Only Type I Portland Cement shall be used unless otherwise provided for in the Special Provisions. Different brands or the same brands from different mills shall not be mixed nor shall they be used alternately unless the mix is approved by the Engineer. However, the use of Portland Pozzolan Cement Type IP meeting the requirements of AASHTO M 240/ASTM C 595, Specifications for Blended Hydraulic Cement shall be allowed, provided that trial mixes shall be done and that the mixes meet the concrete strength requirements, the AASHTO/ASTM provisions pertinent to the use of Portland Pozzolan Cement Type IP shall be adopted.

Cement which for any reason, has become partially set or which contains lumps of caked cement shall be rejected. Cement salvaged from discarded or used bags shall not be used.

Sample of Cement shall be obtained in accordance with AASHTO T 127.

311.2.2 Fine Aggregate

It shall consist of natural sand, stone screenings or other inert materials with similar characteristics, or combinations thereof, having hard, strong and durable particles. Fine aggregate from different sources of supply shall not be mixed or stored in the same pile nor used alternately in the same class of concrete without the approval of the Engineer.

It shall not contain more than three (3) mass percent of material passing the 0.075 mm (No. 200 sieve) by washing nor more than one (1) mass percent each of clay lumps or shale. The use of beach sand will not be allowed without the approval of the Engineer.

If the fine aggregate is subjected to five (5) cycles of the sodium sulfate soundness test, the weighted loss shall not exceed 10 mass percent.

The fine aggregate shall be free from injurious amounts of organic impurities. If subjected to the colorimatic test for organic impurities and a color darker than the standard is produced, it shall be rejected. However, when tested for the effect of organic impurities on strength of mortar by AASHTO T 71, the fine aggregate may be used if the relative strength at 7 and 28 days is not less than 95 percent.

The fine aggregate shall be well-graded from coarse to fine and shall conform to Table 311.1

Table 311.1 – Grading Requirement for Fine Aggregate

Sieve Designation	Mass Percent Passing
9.5 mm (3/8 in)	100
4.75 mm (No. 4)	95 – 100
2.36 mm (No. 8)	-
1.18 mm (No. 16)	45 – 80
0.600 mm (No. 30)	-
0.300 mm (No. 50)	5 – 30
0.150 mm (No. 100)	0 – 10

311.2.3 Coarse Aggregate

It shall consist of crushed stone, gravel, blast furnace slag, or other approved inert materials (coralline or dolomites) of similar characteristics, or combinations thereof, having hard, strong, durable pieces and free from any adherent coatings.

It shall consist of crushed stone, gravel, blast furnace slag, or other approved inert materials of similar characteristics, or combinations thereof, having hard, strong, durable pieces and free from any adherent coatings.

It shall contain not more than one (1) mass percent of material passing the 0.075 mm (No. 200) sieve, not more than 0.25 mass percent of clay lumps, nor more than 3.5 mass percent of soft fragments.

If the coarse aggregate is subjected to five (5) cycles of the sodium sulfate soundness test, the weighted loss shall not exceed 12 mass percent.

It shall have a mass percent of wear not exceeding 40 when tested by AASHTO T 96.

If the slag is used, its density shall not be less than 1120 kg/m³. The gradation of the coarse aggregate shall conform to Table 311.2.

Only one grading specification shall be used from any one source.

Table 311.2 – Grading Requirement for Coarse Aggregate

Sieve Designation		Mass Percent Passing		
Standard mm	Alternate U.S. Standard	Grading A	Grading B	Grading C
75.00	3 in.	100	-	-
63.00	2-1/2 in.	90-100	100	100
50.00	2 in.	-	90-100	95-100
37.5	1-1/2 in.	25 - 60	35-70	-
25.0	1 in.	-	0-15	35-70
19.0	¾ in.	0-10	-	-
12.5	½ in.	0-5	0-5	10-30
4.75	No. 4	-	-	0- 5

311.2.4 Water

Water used in mixing, curing or other designated application shall be reasonably clean and free of oil, salt, acid, alkali, grass or other substances injurious to the finished product. Water will be tested in accordance with and shall meet the requirements of Item 714, Water. Water which is drinkable may be used without test. Where the source of water is shallow, the intake shall be so enclosed as to exclude silt, mud, grass or other foreign materials.

311.2.5 Reinforcing Steel

It shall conform to the requirements of Item 404 Reinforcing Steel. Dowels and tie bars shall conform to the requirements of AASHTO M 31 or M 42, except that rail steel shall not be used for tie bars that are to be bent and restraightened during construction. Tie bars shall be deformed bars. Dowels shall be plain round bars. Before delivery to the site of work, one-half of the length of each dowel shall be painted with one coat of approval lead or tar paint.

The sleeves for dowel bars shall be metal of approved design to cover 50 mm, plus or minus 5 mm of the dowel, with a closed end, and with a suitable stop to hold the end of the sleeve at least 25 mm from the end of the dowel. Sleeves shall be of such design that they do not collapse during construction.

311.2.6 Wire Mesh

The diameter of wire for lateral and longitudinal directions shall not be less than 6 mm in diameter. Tie wire shall be No. 16 gauged annealed wire.

311.2.6.1 Fabrication of Wire Mesh

The spacing on the lateral direction is twice wider than that of the longitudinal direction. The weight of wire mesh shall not be less than 3 kg/m². It shall be fabricated by welding or binding at each crossing point and shall meet the requirements of ASTM A 185.

311.2.6.2 Installation of Wire Mesh

After placement of slip bar placed at every 9.0 m maximum interval for weakened plane joint, wire mesh shall be placed at a depth of 5.0 cm to 7.5 cm below the surface of the slab or at 2/3 of thickness from the bottom of the pavement. It shall be supported by any approved support assemblies or spacers against displacement and shall be tied to it using tie wires. The sheets of the welded wire mesh shall be flat, and proper care shall be observed in handling and placing it to ensure its installation in the proper position.

Welded wire meshes that have become bent or kinked shall be rejected.

311.2.7 Joint Fillers

Poured joint fillers shall be mixed asphalt and mineral or rubber filler conforming to the applicable requirements of Item 705, Joint Materials. It shall also conform to the requirements of AASHTO M173.

As per Item 705.1 Joint Fillers;

Preformed fillers for joints shall conform to the requirements of AASHTO M 33 (ASTM D 994), AASHTO M 153, AASHTO M 213, AASHTO M 220, as specified, and shall be punched to admit the dowels where called for on the Plans. The filler for each joint shall be furnished in a single piece for the depth and width required for the joint unless otherwise authorized by the Engineer. When the use of more than one piece is authorized for a joint, the abutting ends shall be fastened securely and held accurately to shape, by stapling or other positive fastening satisfactory to the Engineer.

311.2.8 Admixtures

Air-entraining admixture shall conform to the requirements of AASHTO M 154.

Chemical admixtures, if specified or permitted, shall conform to the requirements of AASHTO M 194.

Fly Ash, if specified or permitted as a mineral admixture and not exceeding 20% partial replacement of Portland Cement in concrete mix shall conform to the requirements of ASTM C 618.

Admixture/s maybe added to the concrete mix to produce some desired modifications to the properties of concrete if necessary, but

not as partial replacement of cement. If specified, monofilament polypropylene synthetic fibrin fibers, which are used as admixture to prevent the formation of temperature/shrinkage cracks and increase impact resistance of concrete slabs shall be applied in the dosage rate recommended by its manufacturer.

311.2.9 Curing Materials

Curing materials shall conform to the following requirements as specified;

- a) Burlap cloth - AASHTO M 182
- b) Liquid membrane forming compounds - AASHTO M 148
- c) Sheeting (film) Materials - AASHTO M 171

Cotton mats and water-proof paper can be used.

311.2.10 Calcium Chloride/Calcium Nitrate

It shall conform to AASHTO M 144, if specified or permitted by the Engineer, as accelerator.

311.2.11 Storage of Cement and Aggregate

All cement shall be stored, immediately upon delivery at the Site, in weatherproof building which will protect the cement from dampness. The floor shall be raised from the ground. The building shall be placed in locations approved by the Engineer. Provisions for storage shall be ample, and the shipments of cement as received shall be separately stored in such a manner as to allow the earliest deliveries to be used first and to provide easy access for identification and inspection of each shipment. Storage buildings shall have capacity for storage of a sufficient quantity of cement to allow sampling at least twelve (12) days before the cement is to be used. Bulk cement, if used, shall be transferred to elevated air tight and weatherproof bins. Stored cement shall meet the test requirements at any time after storage when retest is ordered by the Engineer. At the time of use, all cement shall be free-flowing and free of lumps.

The handling and storing of concrete aggregates shall be such as to prevent segregation or the inclusion of foreign materials. The Engineer may require that aggregates be stored on separate platforms at satisfactory location.

In order to secure greater uniformity of concrete mix, the Engineer may require that the coarse aggregate be separated into two or more sizes. Different sizes of aggregate shall be stored in separate bins or in separate stockpiles sufficiently removed from each other to prevent the material at the edges of the piles from becoming intermixed.

311.2.12 Proportioning, Consistency and Strength of Concrete

The Contractor shall prepare the design mix based on the absolute volume method as outlined in the American Concrete Institute (ACI) Standard 211.1, "Recommended Practice for Selecting Proportions for Normal and Heavyweight Concrete".

It is the intent of this Specification to require at least 364 kg of cement per cubic meter of concrete to meet the minimum strength requirements. The Engineer shall determine from laboratory tests of the materials to be used, the cement content and the proportions of

aggregate and water that will produce workable concrete having a slump of between 40 and 75 mm (1-1/2 and 3 inches) if not vibrated or between 10 and 40 mm (1/2 and 1-1/2 inches) if vibrated, and a flexural strength of not less than 3.8 MPa (550 psi) when tested by the third-point method or 4.5 MPa (650 psi) when tested by the mid-point method at fourteen (14) days in accordance with AASHTO T97 and T177, respectively; or a compressive strength of 24.1 MPa (3500 psi) for cores taken at fourteen (14) days and tested in accordance with AASHTO T24.

Slump shall be determined using AASHTO T 119.

The designer shall consider the use of lean concrete (econocrete) mixtures using local materials or specifically modified conventional concrete mixes in base course and in the lower course composite, monolithic concrete pavements using a minimum of 75 mm (3 inches) of conventional concrete as the surface course.

The mix design shall be submitted to the Engineer for approval and shall be accompanied with certified test data from an approved laboratory demonstrating the adequacy of the mix design. A change in the source of materials during the progress of work may necessitate a new design mix.

Job mix adjustment of water content shall be allowed only on permission of the Engineer, provided that cement is also added to keep the original water-cement ratio of the design mix.

311.3 Construction Requirements

311.3.1 Quality Control of Concrete

The Contractor shall be responsible for the quality control of all materials during the handling, blending, and mixing and placement operations.

The Contractor shall furnish the Engineer a Quality Control Plan detailing his production control procedures and the type and frequency of sampling and testing to insure that the concrete produces complies with the Specifications. The Engineer shall be provided free access to recent plant production records, and if requested, informational copies of mix design, materials certifications and sampling and testing reports. Experienced and qualified personnel shall perform all batching or mixing operation for the concrete mix, and shall be present at the plant and job site to control the concrete productions whenever the plant is in operation.

311.3.2 Equipment

Equipment and tools necessary for handling materials and performing all parts of the works shall be approved by the Engineer as to design, capacity and mechanical condition. The equipment shall be at the jobsite sufficiently ahead of the start of construction operations to be examined thoroughly and approved. In case of breakdown of such equipment in the process of paving activity, a standby substitute of the

same or equivalent must be available on site as not to hinder the progress of the work and to minimize waste of concrete batches.

The following equipment must be at the jobsite;

1.) Batching Plant and Equipment

- a) The batching shall include bins, weighing hoppers, and scales for the fine aggregate and for each size of coarse aggregate. If cement is used in bulk, a bin, hopper and separate scale for cement shall be included. The weighing hopper shall be properly sealed and vented to preclude dusting operation. The batch plant shall be equipped with a suitable non-resettable batch counter which will correctly indicate the number of batches proportioned.
- b) Bins and Hoppers. Bins with adequate separate compartments for fine aggregate and for each size of coarse aggregate shall be provided in the batching plant.
- c) Scales. Scales for weighing aggregates and cement shall be either the beam type or the springless-dial type. They shall be accurate within one-half percent (0.5%) throughout the range of use. Poises shall be designed to be locked in any position and to prevent unauthorized change. These scales shall be inspected and sealed as often as the Engineer may deem necessary to assure their continued accuracy.
- d) Automatic Weighing Devices. Unless otherwise allowed on the Contract, batching plants shall be equipped with automatic weighing devices of an approved type to proportion aggregates and bulk cement.

2.) Mixers

- a) General. Concrete may be mixed at the site of construction or at the central plant, or wholly or in part in truck mixers. Each mixers shall have a manufacturer's plate attached in a prominent place showing the capacity of the drum in terms of volume of mixed concrete and the speed of rotation of the mixing drum or blades.
- b) Mixers at Site of Construction. Mixing shall be done in an approved mixer capable of combining the aggregates, cement and water into thoroughly mixed and uniform masses within the specified mixing period and discharging and distributing the mixture without segregation on the prepared grade. The mixer shall be equipped with an approved timing device which will automatically lock the discharge lever when the drum

has been charged and released it at the end of the mixing period. In case of failure of timing device, the mixer may be used for the balance of the day while it is being repaired, provided that each batch is mixed 90 seconds. The mixer shall be equipped with a suitable non-resettable batch counter which shall correctly indicate the number of the batches mixed.

- c) Truck Mixers and Truck Agitators. Truck mixers used for mixing and hauling concrete, and truck agitators used for hauling central-mixed concrete, shall conform to the requirements of AASHTO M157.
- d) Non-Agitator Truck. Bodies of non-agitating hauling equipment for concrete shall be smooth, mortar-tight metal containers and shall be capable of discharging the concrete at a satisfactory controlled rate without segregation.

3.) Paving and Finishing Equipment

The concrete shall be placed with an approved paver designed to spread, consolidate, screed and float finish the freshly placed concrete in one complete pass of the machine in such a manner that the minimum of hand finishing will be necessary to provide a dense and homogenous pavement in conformance with the Plans and Specifications.

The finishing machine shall be equipped with at least two (2) oscillating type transverse screed. Vibrators shall operate at a frequency of 8,300 to 9,000 impulses per minute under load at maximum spacing of 60 cm.

4.) Concrete Saw

The Contractor shall provide sawing equipment in adequate number of units and power to complete the sawing with a water-cooled diamond edge saw blade or an abrasive wheel to the required dimensions and at the required rate. The Contractor shall provide at least one (1) standby saw in good working condition and with an ample supply of saw blades.

5.) Forms

Forms shall be steel, of an approved section, and of depth equal to the thickness of the pavement at the edge. The base of the forms shall be of sufficient width to provide necessary stability in all directions. The flange braces must extend outward on the base to not less than $\frac{2}{3}$ the height of the form.

All forms shall be rigidly supported on the bed of thoroughly compacted material during the entire operation

of placing and finishing the concrete. Forms shall be provided with adequate devices for secure setting so that when in place, they will withstand, without visible spring or settlement, the impact and vibration of the consolidation and finishing or paving equipment.

311.3.3 Preparation of Grade

After the subgrade or base has been placed and compacted to the required density, the areas which will support the paving machine and the grade on which the pavement is to be constructed shall be trimmed to the proper elevation by means of a properly designed machine extending the prepared work areas compacted at least 60 cm beyond each edge of the proposed concrete pavement. If loss of density results from the trimming operations, it shall be restored by additional compaction before concrete is placed. If any traffic is allowed to use the prepared subgrade or base, the surface shall be checked and corrected immediately ahead of the placing of concrete.

The subgrade or base shall be uniformly moist when the concrete is placed.

311.3.4 Setting Forms

The foundation under the forms shall be hard and true to grade so that the form when set will be firmly in contact for its whole length and at the specified grade. Any roadbed, which at the form line is found below established grade, shall be filled with approved granular materials to grade in lifts of three (3) cm variations above grade shall be corrected by tamping or by cutting as necessary.

Forms shall be set sufficiently in advance of the point where concrete is being placed. After the forms have been set to correct grade, the grade shall be thoroughly tamped, mechanically or by hand, at both the inside and outside edges of the base of the forms. The forms shall not deviate from true line by more than one (1) cm at any point.

The alignment and grade elevations of the forms shall be checked and corrections made by the Contractor immediately before placing the concrete. Testing as to crown and elevation, prior to placing of concrete can be made by means of holding an approved template in a vertical position and moved backward and forward on the forms.

When any form has been disturbed or any grade has become unstable, the form shall be reset and rechecked.

311.3.5 Conditioning of Subgrade or Base Course

When side forms have been securely set to grade, the subgrade or base course shall be brought to proper cross-section. High areas shall be trimmed to proper elevation. Low areas shall be filled and compacted to a condition similar to that of surrounding grade. The finished grade shall be maintained in a smooth and compacted condition until the pavement is placed.

Unless waterproof subgrade or base course cover material is specified, the subgrade or base course shall be uniformly moist when the concrete is placed. If it subsequently becomes too dry, the subgrade or base course shall be sprinkled, but the method of sprinkling shall not be such as to form mud or pools of water.

311.3.6 Handling, Measuring and Batching Materials

The batch plant site, layout, equipment and provisions for transporting material shall be such as to assure a continuous supply of material to the work.

Stockpiles shall be built up in layers of not more than one (1) meter in thickness. Each layer shall be completely in place before beginning the next which shall not be allowed to "cone" down over the next lower layer. Aggregates from different sources and of different grading shall not be stockpiled together.

All washed aggregates and aggregates produced or handled by hydraulic methods, shall be stockpiled or binned for draining at least twelve (12) hours before being batched.

When mixing is done at the side of the work, aggregates shall be transported from the batching plant to the mixer in batch boxes, vehicle bodies, or other containers of adequate capacity and construction to properly carry the volume required. Partitions separating batches shall be adequate and effective to prevent spilling from one compartment to another while in transit or being dumped. When bulk cement is used, the Contractor shall use a suitable method of handling the cement from weighing hopper to transporting container or into the batch itself for transportation to the mixer, with chute, boot or other approved device, to prevent loss of cement, and to provide positive assurance of the actual presence in each batch of the entire cement content specified.

Bulk cement shall be transported to the mixer in tight compartments carrying the full amount of cement required for the batch. However, if allowed in the Special Provisions, it may be transported between the fine and coarse aggregate. When cement is placed in contact with the aggregates, batches may be rejected unless mixed within 1-1/2 hours of such contact. Cement in original shipping packages may be transported on top of the aggregates, each batch containing the number of sacks required by the job mix.

The mixer shall be charged without loss of cement. Batching shall be so conducted as to result in the weight to each material required within a tolerance of one (1) percent for the cement and two (2) percent for aggregates.

Water may be measured either by volume or by weight. The accuracy of measuring the water shall be within a range of error of not over than one (1) percent. Unless the water is to be weighed, the water-measuring equipment shall include an auxiliary tank from which the measuring tank shall be equipped with an outside tap and valve to provide checking the setting, unless other means are provided for readily and accurately

determining the amount of water in the tank. The volume of the auxiliary tank shall be at least equal to that of the measuring tank.

311.3.7 Mixing Concrete

The concrete may be mixed at the site of the work in a central-mix plant, or in truck mixers. The mixer shall be of an approved type and capacity. Mixing time will be measured from the time all materials, except water, are in the drum. Ready-mixed concrete shall be mixed and delivered in accordance with requirements of AASHTO M 157, except that the minimum required revolutions at the mixing speed for transit-mixed concrete may be reduced to not less than that recommended by the mixer manufacturer. The number of revolutions recommended by the mixer manufacturer shall be indicated on the manufacturer's serial plate attached to the mixer.

The Contractor shall furnish test data acceptable to the Engineer verifying that the make and model of the mixer will produce uniform concrete conforming to the provision of AASHTO M 157 at the reduced number of revolutions shown on the serial plate.

When mixed at the site or in a central mixing plant, the mixing time shall not be less than fifty (50) seconds nor more than ninety (90) seconds, unless mixer performance tests prove adequate mixing of the concrete in a shorter time period.

Four (4) seconds shall be added to the specified mixing time if timing starts at the instant the skip reaches its maximum raised positions. Mixing time ends when the discharge chute opens. Transfer time in multiple drum mixers is included in mixing time. The contents of an individual mixer drum shall be removed before a succeeding batch is emptied therein.

The mixer shall be operated at the drum speed as shown on the manufacturer's name plate attached on the mixer. Any concrete mixed less than the specified time shall be discarded and disposed off by the Contractor at his expense. The volume of concrete mixed per batch shall not exceed the mixer's nominal capacity in cubic meter, as shown on the manufacturer's standard rating plate on the mixer, except that an overload up to ten (10) percent above the mixer's nominal capacity may be permitted provided concrete test data for strength, segregation, and uniform consistency are satisfactory, and provided no spillage of concrete takes place.

The batches shall be so charged into the drum that a portion of the mixing water shall be entered in advance of the cement and aggregates. The flow of water shall be uniform and all water shall be in the drum by the end of the first fifteen (15) seconds of the mixing period. The throat of the drum shall be kept free of such accumulations as may restrict the free flow of materials into the drum.

Mixed concrete from the central mixing plant shall be transported in truck mixers, truck agitators or non-agitating truck specified in Subsection 311.3.2, Equipment. The time elapsed from the time water is added to the mix until the concrete is deposited in place at the Site shall not

exceed forty five (45) minutes when the concrete is hauled in non-agitating trucks, nor ninety (90) minutes when hauled in truck mixers or truck agitators, except that in hot weather or under other conditions contributing to quick hardening of the concrete, the maximum allowable time may be reduced by the Engineer.

Re-tempering concrete by adding water or by other means shall not be permitted, except that when concrete is delivered in truck mixers, additional water may be added to the batch materials and additional mixing performed to increase the slump to meet the specified requirements, if permitted by the Engineer, provided all these operations are performed within forty-five (45) minutes after the initial mixing operation and the water-cement ratio is not exceeded. Concrete that is not within the specified slump limits at the time of placement shall not be used.

Admixtures for increasing the workability or for accelerating the setting of the concrete will be permitted only when specifically approved by the Engineer.

311.3.8 Limitation of Mixing

No concrete shall be mixed, placed or finished when natural light is insufficient, unless an adequate and approved artificial lighting system is operated.

During hot weather, the Engineer shall require that steps be taken to prevent the temperature of mixed concrete from exceeding a maximum temperature of 90°F (32°C)

Concrete not in place within ninety (90) minutes from the time the ingredients were charged into the mixing drum or that has developed initial set shall not be used. Re-tempering of concrete or mortar which has partially hardened, that is remixing with or without additional cement, aggregate, or water, shall not be permitted.

In order that the concrete may be properly protected against the effects of rain before the concrete is sufficiently hardened, the Contractor will be required to have available at all times materials for the protection of the edges and surface of the unhardened concrete.

311.3.9 Placing Concrete

Concrete shall be deposited in such a manner to require minimal rehandling. Unless truck mixers or non-agitating hauling equipment are equipped with means to discharge concrete without segregation of the materials, the concrete shall be unloaded into an approved spreading device and mechanically spread on the grade in such a manner as to prevent segregation. Placing shall be continuous between transverse joints without the use of intermediate bulkheads. Necessary hand spreading shall be done with shovels, not rakes. Workmen shall not be allowed to walk in the freshly mixed concrete with boots or shoed coated with earth or foreign substances.

When concrete is to be placed adjoining a previously constructed lane and mechanical equipment will be operated upon the existing lane, that

previously constructed lane shall have attained the strength for fourteen (14) day concrete. If only finishing equipment is carried on the existing lane, paving in adjoining lanes may be permitted after three (3) days.

Concrete shall be thoroughly consolidated against and along the faces of all forms and along the full length and on both sides of all joint assemblies, by means of vibrators inserted in the concrete. Vibrators shall not be permitted to come in contact with a joint assembly, the grade, or a side form. In no case shall the vibrator be operated longer than fifteen (15) seconds in any one location.

Concrete shall be deposited as near as possible to the expansion and contraction joints without disturbing them, but shall not be dumped from the discharge bucket or hopper into a joint assembly unless the hopper is well centered on the joint assembly. Should any concrete material fall on or be worked into the surface of a complete slab, it shall be removed immediately.

311.3.10 Test Specimens

As the work progresses, at least one (1) set consisting of three (3) concrete beam test specimens, 150 mm x 150 mm x 525 mm or 900 mm shall be taken from each 330 m² of pavement, 230 mm depth, or fraction thereof placed each day.

Test specimens shall be made under the supervision of the Engineer, and the Contractor shall provide all concrete and other facilities necessary in making the test specimens and shall protect them from damage by construction operations. Cylinder samples shall not be used as substitute for determining the adequacy of the strength of concrete.

The beams shall be made, cured, and tested in accordance with AASHTO T 23 and T 97.

311.3.11 Strike-off of Concrete and Placement of Reinforcement

Following the placing of the concrete, it shall be struck off to conform to the cross-section shown on the Plans and to an elevation such that when the concrete is properly consolidated and finished, the surface of the pavement will be at the elevation shown on the Plans. When reinforced concrete pavement is placed in two (2) layers, the bottom layer shall be struck off and consolidated to such length and depth that the sheet of fabric or bar mat may be laid full length on the concrete in its final position without further manipulation. The reinforcement shall then be placed directly upon the concrete, after which the top layer of the concrete shall be placed, struck off and screeded. Any portion of the bottom layer of concrete which has been placed more than 30 minutes without being covered with the top layer shall be removed and replaced with freshly mixed concrete at the Contractor's expense. When reinforced concrete is placed in one layer, the reinforcement may be firmly positioned in advance of concrete placement or it may be placed at the depth shown on the Plans in plastic concrete, after spreading by mechanical or vibratory means.

Reinforcing steel shall be free from dirt, oil, paint, grease, mill scale and loose or thick rust which could impair bond of

311.3.12 Joints

Joints shall be constructed of the type and dimensions, and at the locations required by the Plans or Special Provisions. All joints shall be protected from the intrusion of injurious foreign material until sealed.

1. Longitudinal Joint

Deformed steel tie bars of specified length, size, spacing and materials shall be placed perpendicular to the longitudinal joints, they shall be placed by approved mechanical equipment or rigidly secured by chair or other approved supports to prevent displacement. Tie bars shall not be painted or coated with asphalt or other materials or enclosed in tubes or sleeves. When shown on the Plans and when adjacent lanes of pavement are constructed separately, steel side forms shall be used which will form a keyway along the construction joint. Tie bars, except those made of rail steel, may be bent at right angles against the form of the first lane constructed and straightened into final position before the concrete of the adjacent lane is placed, or in lieu of bent tie bars, approved two-piece connectors may be used.

Longitudinal formed joints shall consist of a groove or cleft, extending downward from and normal to, the surface of the pavement. These joints shall be effected or formed by an approved mechanically or manually operated device to the dimensions and line indicated on the Plans and while the concrete is in a plastic state. The groove or cleft shall be filled with either a premolded strip or poured material as required.

The longitudinal joints shall be continuous, there shall be no gaps in either transverse or longitudinal joints at the intersection of the joints.

Longitudinal sawed joints shall be cut by means of approved concrete saws to the depth, width and line shown on the Plans. Suitable guide lines or devices shall be used to assure cutting the longitudinal joint on the true line. The longitudinal joint shall be sawed before the end of the curing period or shortly thereafter and before any equipment or vehicles are allowed on the pavement. The sawed area shall be thoroughly cleaned and, if required, the joint shall immediately be filled with sealer.

Longitudinal pavement insert type joints shall be formed by placing a continuous strip of plastic materials which will not react adversely with the chemical constituent of the concrete.

2. Transverse Expansion Joint

The expansion joint filler shall be continuous from form to form, shaped to subgrade and to the keyway along the form. Preformed joint filler shall be furnished in lengths equal to the pavement width or equal to the width of one lane. Damaged or repaired joint filler shall not be used.

The expansion joint filler shall be held in a vertical position. An approved installing bar, or other device, shall be used if required to secure preformed expansion joint filler at the proper grade and alignment during placing and finishing of the concrete. Finished joint shall not deviate more than 6 mm from a straight line. If joint fillers are assembled in sections, there shall be no offsets between adjacent units. No plugs of concrete shall be permitted anywhere within the expansion space.

3. Transverse Contraction Joint/Weakened Joint

When shown on the Plans, it shall consist of planes of weakness created by forming or cutting grooves in the surface of the pavement and shall include load transfer assemblies. The depth of the weakened plane joint should at all times not be less than 50 mm, while the width should not be more than 6 mm.

- a. Transverse Strip Contraction Joint. It shall be formed by installing a parting strip to be left in place as shown on the Plans.
- b. Formed Groove. It shall be made by depressing an approved tool or device into the plastic concrete. The tool or device shall remain in place at least until the concrete has attained its initial set and shall then be removed without disturbing the adjacent concrete, unless the device is designed to remain in the joint.
- c. Sawed Contraction Joint. It shall be created by sawing grooves in the surface of the pavement of the width not more than 6 mm, depth should at all times not be less than 50 mm, and at the spacing and lines shown on the Plans, with an approved concrete saw. After each joint is sawed, it shall be thoroughly cleaned including the adjacent concrete surface.

Sawing of the joint shall commence as soon as the concrete has hardened sufficiently to permit sawing without excessive raveling, usually 4 to 24 hours. All joints shall be sawed before uncontrolled shrinkage cracking takes place. If necessary, the sawing operations shall be carried on during the day or night, regardless of weather conditions.

The sawing of any joint shall be omitted if crack occurs at or near the joint location prior to the time of sawing. Sawing shall be discontinued when a crack develops ahead of the saw. In general, all joints should be sawed in sequence. If extreme condition exist which make it impractical to prevent erratic cracking by early sawing, the contraction joint groove shall be formed prior to initial set of concrete as provided above.

4. Transverse Construction Joint

It shall be constructed when there is an interruption of more than 30 minutes in the concreting operations. No transverse joint shall be constructed within 1.50 m of an expansion joint, contraction joint, or

plane of weakness. If sufficient concrete has been mixed at the time of interruption to form a slab of at least 1.5 m long, the excess concrete from the last preceding joint shall be removed and disposed off as directed.

5. Load Transfer Device

Dowel, when used, shall be held in position parallel to the surface and center line of the slab by a metal device that is left in the pavement.

The portion of each dowel painted with one coat of lead or tar, in conformance with the requirements of Item 404, Reinforcing Steel, shall be thoroughly coated with approved bituminous materials, e.g., MC-70, or an approved lubricant, to prevent the concrete from binding to that portion of the dowel. The sleeves for dowels shall be metal designed to cover 50 mm plus or minus 5 mm (1/4 inch), of the dowel, with a watertight closed end and with a suitable stop to hold the end of the sleeves at least 25 mm (1 inch) from the end of the dowel.

In lieu of using dowel assemblies at contraction joints, dowel may be placed in the full thickness of pavement by a mechanical device approved by the Engineer.

311.3.13 Final Strike-off (Consolidation and Finishing)

1. Sequence

The sequence of operations shall be the strike-off and consolidation, floating and removal of laitance, straight-edging and final surface finish. Work bridges or other devices necessary to provide access to the pavement surface for the purpose of finishing straight-edging, and make corrections as hereinafter specified, shall be provided by the Contractor.

In general, the addition of water to the surface of the concrete to assist in finishing operations will not be permitted. If the application of water to the surface is permitted, it shall be applied as fog spray by means of an approved spray equipment.

2. Finishing Joints

The concrete adjacent to joints shall be compacted or firmly placed without voids or segregation against the joint material assembly, also under and around all load transfer devices, joint assembly units, and other features designed to extend into the pavement. Concrete adjacent to joints shall be mechanically vibrated as required in Subsection 311.3.9, Placing Concrete.

After the concrete has been placed and vibrated adjacent to the joints as required in Subsection 311.3.9, the finishing machine shall be brought forward, operating in a manner to avoid damage or misalignment of joints. If uninterrupted operation of the finishing machine, to over and beyond the joints causes segregation of

concrete, damage to, or misalignment of the joints, the finishing machine shall be stopped when the front screed is approximately 20 cm (8 inches) from the joint. Segregated concrete shall be removed from in front of and off the joint. The front screed shall be lifted and set directly on top of the joint and the forward motion of the finishing machine resumed. When the second screed is close enough to permit the excess mortar in front of it to flow over the joint, it shall be lifted and carried over the joint. Thereafter, the finishing machine may be run over the joint without lifting the screeds, provided there is no segregated concrete immediately between the joint and the screed or on top of the joint.

3. Machine Finishing

- a. Non-Vibratory Method. The concrete shall be distributed or spread as soon as placed. As soon as the concrete has been placed, it shall be struck off and screeded by an approved finishing machine. The machine shall go over each area of pavement as many times and at such intervals as necessary to give the proper compaction and leave a surface of uniform texture. Excessive operation over a given area shall be avoided. The tops of the forms shall be kept clean by an effective device attached to the machine and the travel of the machine on the forms shall be maintained true without wobbling or other variation tending to affect the precision finish.

During the first pass of the finishing machine, a uniform ridge of concrete shall be maintained ahead of the front screed in its entire length.

- b. Vibratory Method. When vibration is specified, vibrators for full width vibration of concrete paving slabs, shall meet the requirements in Subsection 311.3.2, Equipment. If uniform and satisfactory density of the concrete is not obtained by the vibratory method at joints, along forms, at structures, and throughout the pavement, the Contractor will be required to furnish equipment and method which will produce pavement conforming to the Specifications. All provisions in item (a) above not in conflict with the provisions for the vibratory method shall govern.

4. Hand Finishing

Hand finishing methods may only be used under the following conditions:

- a. In the event of breakdown of the mechanical equipment, hand methods may be used to finish the concrete already deposited on the grade.
- b. In narrow widths or areas of irregular dimensions where operations of the mechanical equipment is impractical, hand methods may be used.

Concrete, as soon as placed, shall be struck off and screeded. An approved portable screed shall be used. A second screed shall be provided for striking off the bottom layer of concrete if reinforcement is used.

The screed for the surface shall be at least 60 cm (2 feet) longer than the maximum width of the slab to be struck off. It shall be of approved design, sufficiently rigid to retain its shape, and constructed either of metal or other suitable material shod with metal.

Consolidation shall be attained by the use of suitable vibrator or other approved equipment.

In operation, the screed shall be moved forward on the forms with a combined longitudinal and transverse shearing motion, moving always in the direction in which the work is progressing and so manipulated that neither end is raised from the side forms during the striking off process. If necessary, this shall be repeated until the surface is of uniform texture, true to grade and cross-section, and free from porous areas.

5. Floating

After the concrete has been struck off and consolidated, it shall be further smoothed, trued, and consolidated by means of a longitudinal float, either by hand or mechanical method.

- a. Hand Method. The hand-operated longitudinal float shall be not less than 365 cm (12 feet) in length and 15 cm (6 inches) in width, properly stiffened to prevent flexibility and warping. The longitudinal float, operated from foot bridges resting on the side forms and spanning but not touching the concrete, shall be worked with a sawing motion while held in a floating position parallel to the road center line, and moving gradually from one side of the pavement to the other. Movement ahead along the center line of the pavement shall be in successive advances of not more than one-half the length of the float. Any excess water or soupy material shall be wasted over the side forms on each pass.
- b. Mechanical Method. The mechanical longitudinal float shall be of a design approved by the Engineer, and shall be in good working condition. The tracks from which the float operates shall be accurately adjusted to the required crown. The float shall be accurately adjusted and coordinated with the adjustment of the transverse finishing machine so that a small amount of mortar is carried ahead of the float at all times. The forward screed shall be adjusted so that the float will lap the distance specified by the Engineer on each transverse trip. The float shall pass over each areas of pavement at least two times, but excessive operation over a given area will not be permitted. Any excess water or soupy material shall be wasted over the side forms on each pass.
- c. Alternative Mechanical Method. As an alternative, the Contractor may use a machine composed of a cutting and smoothing float or floats suspended from and guided by a rigid frame. The frame shall be carried by four or more visible wheels riding on, and constantly in contact with the side

forms. If necessary, following one of the preceding method of floating, long handled floats having blades not less than 150 cm (5 feet) in length and 15 cm (6 inches) in width may be used to smooth and fill in open-textured areas in the pavement. Long-handled floats shall not be used to float the entire surface of the pavement in lieu of, or supplementing, one of the preceding methods of floating. When strike off and consolidation are done by the hand method and the crown of the pavement will not permit the use of the longitudinal float, the surface shall be floated transversely by means of the long-handled float. Care shall be taken not to work the crown out of the pavement during the operation. After floating, any excess water and laitance shall be removed from the surface of the pavement by a 3-m straight-edge or more in length. Successive drags shall be lapped one-half the length of the blade.

6. Straight-edge Testing and Surface Correction

After the floating has been completed and the excess water removed, but while the concrete is still plastic, the surface of the concrete shall be tested for trueness with a 300 cm long straight-edge.

For this purpose, the Contractor shall furnish and use an accurate 300-cm straight-edge swung from handles 100 cm (3 feet) longer than one-half the width of the slab. The straight-edge shall be held in contact with the surface in successive positions parallel to the road center line and the whole area gone over from one side of the slab to the other as necessary. Advances along the road shall be in successive stages of not more than one-half the length of the straight-edge.

Any depressions found shall be immediately filled with freshly mixed concrete, struck off, consolidated and refinished. High areas shall be cut down and refinished. Special attention shall be given to assure that the surface across joints meets the requirements for smoothness. Straight-edge testing and surface corrections shall continue until the entire surface is found to be free from observable departures from the straight-edge and the slab conforms to the required grade and cross-section.

7. Final Finish

If the surface texture is broom finished, it shall applied when the water sheen has practically disappeared. The broom shall be drawn from the center to the edge of the pavement with adjacent strokes slightly overlapping. The brooming operation should be so executed that the corrugations produced in the surface shall be uniform in appearance and not more than 1.5 mm in depth.

Brooming shall be completed before the concrete is in such condition that the surface will be unduly roughened by the

operation. The surface thus finished shall be free from rough and porous areas, irregularities, and depressions resulting from improper handling of the broom. Brooms shall be of the quality size and construction and be operated so as to produce a surface finish meeting the approval of the Engineer. Subject to satisfactory results being obtained and approval of the Engineer, the Contractor will be permitted to substitute mechanical brooming in lieu of the manual brooming herein described.

If the surface texture is belt finished, when straight-edging is complete and water sheen has practically disappeared and just before the concrete becomes non-plastic, the surface shall be belted with 2-ply canvass belt not less than 20 cm wide and at least 100 cm longer than the pavement width. Hand belts shall have suitable handles to permit controlled, uniform manipulation. The belt shall be operated with short strokes transverse to the center line and with a rapid advances parallel to the center line.

If the surface texture is drag finished, a drag shall be used which consists of a seamless strip of damp burlap or cotton fabric, which shall produce a uniform of gritty texture after dragging it longitudinally along the full width of pavement. For pavement 5 m or more in width, the drag shall be mounted on a bridge which travels on the forms. The dimensions of the drag shall be such that a strip of burlap or fabric at least 100 cm wide is in contact with the full width of pavement surface while the drag is used. The drag shall consist of not less than 2 layers of burlap with the bottom layer approximately 15 cm wider than the layer. The drag shall be maintained in such condition that the resultant surface is of uniform appearance and reasonably free from grooves over 1.5 mm in depth. Drag shall be maintained clean and free from encrusted mortar. Drags that cannot be cleaned shall be discarded and new drags be substituted.

Regardless of the method used for final finish, the hardened surface of pavement shall have a coefficient of friction of 0.25 or more. Completed pavement that is found to have a coefficient of friction less than 0.25 shall be grounded or scored by the Contractor at his expense to provide the required coefficient of friction.

8. Edging at Forms and Joints

After the final finish, but before the concrete has taken its initial set, the edges of the pavement along each side of each slab, and on each side of transverse expansion joints, formed joints, transverse construction joints, and emergency construction joints, shall be worked with an approved tool and rounded to the radius required by the Plans. A well – defined and continuous radius shall be produced and a smooth, dense mortar finish obtained. The surface of the slab shall not be unduly disturbed by tilting the tool during the use.

At all joints, any tool marks appearing on the slab adjacent to the joints shall be eliminated by brooming the surface. In doing this, the rounding of the corner of the slab shall not be disturbed. All concrete on top of the joint filler shall be completely removed.

All joints shall be tested with a straight-edge before the concrete has set and correction made if one edge of the joint is higher than the other.

311.3.14 Surface Test

As soon as the concrete has hardened sufficiently, the pavement surface shall be tested with a 3-m straight-edge or other specified device. Areas showing high spots of more than 3 mm but not exceeding 12 mm in 3 m shall be marked and immediately ground down with an approved grinding tool to an elevation where the area or spot will not show surface deviations in excess of 3 mm when tested with 3 m straight-edge. Where the departure from correct cross-section exceeds 12 mm, the pavement shall be removed and replaced by and at the expense of the Contractor.

Any area or section so removed shall be not less than 1.5 m in length and not less than the full width of the lane involved. When it is necessary to remove and replace a section of pavement, any remaining portion of the slab adjacent to the joints that is less than 1.5 m in length, shall also be removed and replaced.

311.3.15 Curing

Immediately after the finishing operations have been completed and the concrete has sufficiently set, the entire surface of the newly placed concrete shall be cured in accordance with either one of the methods described herein. Failure to provide sufficient cover material of whatever kind the Contractor may elect to use, or the lack of water to adequately take care of both curing and other requirements, shall be a cause for immediate suspension of concreting operations. The concrete shall not be left exposed for more than ½ hour between stages of curing or during the curing period.

311.3.16 Removal of Forms

Forms for concrete shall remain in place undisturbed for not less than twenty four (24) hours after concrete pouring. In the removal of forms, crowbars should be used in pulling out nails and pins. Care should be taken so as not to break the edges of the pavement. In case portions of the concrete are spalled, they shall be immediately repaired with fresh mortar mixed in the proportion of one part of Portland Cement and two parts fine aggregates. Major honeycomb areas will be considered as defective work, and shall be removed and replaced at the expense of the Contractor. Any area or section so removed shall not be less than the distance between weakened plane joint nor less than the full width of the lane involved.

311.3.17 Sealing Joints

Joint shall be sealed with asphalt sealant soon after completion of the curing period and before the pavement is opened to traffic, including the Contractor's equipment. Just prior to sealing, each joint shall be thoroughly cleaned of all foreign materials including membrane curing compound and the joint faces shall be clean and surface dry when the seal is applied.

The sealing material shall be applied to each joint opening to conform to the details shown on the plans or as directed by the Engineer. Material for seal applied hot shall be stirred during heating so that localized overheating does not occur. The pouring shall be done in such a manner that the material will not be spilled on the exposed surfaces of the concrete. The use of sand or similar material as a cover for the seal will not be permitted.

311.3.18 Protection of Pavement

The Contractor shall protect the pavement and its appurtenances against both public traffic and traffic caused by his own employees and agents. This shall include watchmen to direct traffic and the erection of and maintenance of warning signs, lights, pavement bridges or cross-overs, etc. The Plans or Special Provisions will indicate the location and type of device or facility required to protect the work and provide adequately for traffic.

All boreholes after thickness and/or strength determinations of newly constructed asphalt and concrete pavements shall be immediately filled/restored with the prescribed concrete/asphalt mix after completion of the drilling works.

Any damage to the pavement, occurring prior to final acceptance, shall be repaired or the pavement be replaced.

311.3.19 Concrete Pavement – Slip Form Method

If the Contract calls for the construction of pavement without the use of fixed forms, the following provisions shall apply:

1. Grade

After the grade or base has been placed and compacted to the required density, the areas which will support the paving machine shall be cut to the proper elevation by means of a properly designed machine. The grade on which the pavement is to be constructed shall then be brought to the proper profile by means of properly designed machine. If the density of the base is disturbed by the grading operation, it shall be corrected by additional compaction before concrete is placed. The grade should be constructed sufficiently in advance of the placing of the concrete. If any traffic is allowed to use the prepared grade, the grade shall be checked and corrected immediately before the placing of concrete.

2. Placing Concrete

The concrete shall be placed with an approved slip-form paver designed to spread, consolidate, screed and float-finish the freshly placed

concrete in one complete pass of the machine in such a manner that a minimum of hand finish will be necessary to provide a dense and homogenous pavement in conformance with the Plans and Specifications. The machine shall vibrate the concrete for the full width and depth of the strip of pavement being placed. Such vibration shall be accompanied with vibrating tubes or arms working in the concrete or with a vibrating screed or pan operating on the surface of the concrete. The sliding forms shall be rigidly held together laterally to prevent spreading of the forms. The forms shall trail behind the paver for such a distance that no appreciable slumping of the concrete will occur, and that necessary final finishing can be accomplished while the concrete is still within the forms. Any edge slump of the pavement, exclusive of edge rounding, in excess of 6 mm shall be corrected before the concrete has hardened.

The concrete shall be held at a uniform consistency, having a slump of not more than 40 mm (1-12/ inches). The slip form paver shall be operated with as nearly as possible a continuous forward movement and that all operations of mixing, delivering and spreading concrete shall be coordinated so as to provide uniform progress with stopping and starting of the paver held to a minimum. If, for any reason, it is necessary to stop the forward movement of the paver the vibratory and tamping elements shall also be stopped immediately. No tractive force shall be applied to the machine, except that which is controlled from the machine.

3. Finishing

The surface smoothness and texture shall meet the requirements of Subsections 311.3.13 and 311.3.14.

4. Curing

Unless otherwise specified, curing shall be done in accordance with one of the methods included in Subsection 311.3.15. The curing media shall be applied at the appropriate time and shall be applied uniformly and completely to all surfaces and edges of the pavement.

5. Joints

All joints shall be constructed in accordance with Subsection 311.3.12.

6. Protection Against Rain

In order that the concrete may be properly protected against rain before the concrete is sufficiently hardened, the Contractor will be required to have available at all times, materials for the protection of the edges and surface of the unhardened concrete.

Such protective materials shall consist of standard metal forms or wood planks having a nominal thickness of not less than 50 mm (2 inches) and a nominal width of not less than the thickness of the pavement at its edge for the protection of the pavement edges, and covering material such as burlap or cotton mats, curing paper or plastic sheeting materials for the protection of the surface of the pavement. When rain appears imminent, all paving operations shall stop and all available personnel

shall begin placing forms against the sides of the pavement and covering the surface of the unhardened concrete with the protective covering.

311.3.20 Acceptance of Concrete

The strength level of the concrete will be considered satisfactory if the averages of all sets of three (3) consecutive strength test results equal or exceed the specified strength, f_c' and no individual strength test result is deficient by more than 15% of the specified strength, f_c' . A set shall consist of a minimum of three (3) concrete beam specimens.

Concrete deemed to be not acceptable using the above criteria may be rejected unless the Contractor can provide evidence, by means of core tests, that the quality of concrete represented by failed test results is acceptable in place. At least three (3) representative cores shall be taken from each member or area of concrete in place that is considered deficient. The location of cores shall be determined by the Engineer so that there will be at least impairment of strength of the structure. The obtaining and testing of drilled cores shall be in accordance with AASHTO T 24.

Concrete in the area represented by the cores will be considered adequate if the average strength of the cores is equal to at least 85% of, and if no single core is less than 75% of, the specified strength, f_c' .

If the strength of control specimens does not meet the requirements of this Subsection, and it is not feasible or not advisable to obtain cores from the structure due to structural considerations, payment of the concrete will be made at an adjusted price due to strength deficiency of concrete specimens as specified hereunder:

Deficiency in Strength of Concrete Specimens, Percent (%)	Percent (%) of Contract Price Allowed
Less than 5	100
5 to less than 10	80
10 to less than 15	70
15 to less than 20	60
20 to less than 25	50
25 or more	0

1.3.21 Opening to Traffic

The Engineer will decide when the pavement may be opened to traffic. The road will not be opened to traffic until test specimens molded and cured in accordance with AASHTO T 23 have attained the minimum strength requirements in Subsection 311.2.12. If such tests are not conducted prior to the specified age the pavement shall not be operated to traffic until 14 days after the concrete was placed. Before opening to traffic, the pavement shall be cleaned and joint sealing completed.

311.3.22 Tolerance and Pavement Thickness

1. General

The thickness of the pavement will be determined by measurement of cores from the completed pavement in accordance with AASHTO T 148.

The completed pavement shall be accepted on a lot basis. A lot shall be considered as 1000 linear meters of pavement when a single traffic lane is poured or 500 linear meters when two lanes are poured concurrently. The last unit in each slab constitutes a lot in itself when its length is at least $\frac{1}{2}$ of the normal lot length. If the length of the last unit is shorter than $\frac{1}{2}$ of the normal lot length, it shall be included in the previous lot.

Other areas such as intersections, entrances, crossovers, ramp, etc., will be grouped together to form a lot. Small irregular areas may be included with other unit areas to form a lot. Each lot will be divided into five (5) equal segments and one core will be obtained from each segment in accordance with AASHTO T 24.

2. Pavement Thickness

It is the intent of this Specification that the pavement has a uniform thickness as called for on the Plans for the average of each lot as defined. After the pavement has met all surface smoothness requirements, cores for thickness measurements will be taken.

In calculating the average thickness of the pavement, individual measurements which are in excess of the specified thickness by more than 5 mm will be considered as the specified thickness plus 5 mm and measurement which are less than the specified thickness by more than 25 mm shall not be included in the average. When the average thickness for the lot is deficient, the contract unit price will be adjusted for thickness in accordance with paragraph (3 below).

Individual areas within a segment found deficient in thickness by more than 25 mm shall be evaluated by the Engineer, and if in his judgment, the deficient areas warrant removal, they shall be removed and replaced by the Contractor with pavement of the specified thickness at his entire expense. However, if the evaluation of the Engineer is that the deficient area should not be removed and replaced, such area will not be paid.

When the measurement of any core is less than the specified thickness by more than 25 mm, the actual thickness of the pavement in this area will be determined by taking additional cores at no less than 5 m intervals parallel to the center line in each direction from the affected location until a core is found in each direction, which is not deficient in thickness by more than 25 mm. The area of slab for which no payment will be made shall be the product of the paving width multiplied by the distance along the center line of the road between transverse sections found not deficient in thickness by more than 25 mm. The thickness of the remainder of the segment to be used to get the average thickness of

each lot shall be determined by taking the average thickness of additional cores which are not deficient by more than 25 mm.

3. Adjustment for Thickness

When the average thickness of the pavement per lot is deficient, payment for the lot shall be adjusted as follows:

Deficiency in the Average Thickness per lot (mm)	Percent (%) of Contract Price Per Lot
0 - 5	100 % payment
6 - 10	80 % payment
11 - 15	70 % payment
16 - 20	60 % payment
21 - 25	50 % payment
More than 25	Remove and replace/No payment

No acceptance and final payment shall be made on completed pavement unless core test for thickness determination is conducted, except for Barangay Roads where the implementing office is allowed to waive such test.

311.4 Method of Measurement

The area to be paid for under this Item shall be the number of square meters (m²) of concrete placed and accepted in the completed pavement with or without rebar or wire mesh reinforcement. The width for measurements will be the width from outside edge to outside edge of completed pavement as placed in accordance with the Plans or as otherwise required by the Engineer in writing. The length will be measured horizontally along the center line of each roadway or ramp. Any curb and gutter placed shall not be included in the area of concrete pavement measured.

311.5 Basis of Payment

The accepted quantity, measured as prescribed in Section 311.4, shall be paid for at the contract unit price for Portland Cement Concrete Pavement and Portland Cement Concrete Pavement (Reinforced with Wire Mesh) which price and payment shall be full compensation for preparation of roadbed and finishing of shoulders, unless otherwise provided by the Special Provisions, furnishing and placing all joint materials, for sawing weakened plane joints, for fitting the prefabricated center metal joint, for facilitating and controlling traffic, and for furnishing all labor, equipment, tools and incidentals necessary to complete the Item.

Payment will be made under:

Pay Item Number	Description	Unit of Measurement
311(1)f1	Portland Cement Concrete Pavement (Unreinforced) 0.30m thick	Square Meter

PART F

BRIDGE CONSTRUCTION

PART F BRIDGE CONSTRUCTION**ITEM 400 PILING****400.1 Description****400.1.1 Scope**

This Item shall consist of piling, furnished, driven or placed, cut and spliced in accordance with this Specification and in reasonably close conformity with the Plans. This also includes the construction of reinforced concrete piles, cast in bored holes and drilled with the use of special equipment. It shall include the excavation and drilling of holes, furnishing and placing of temporary steel casing and other incidentals necessary for the execution of the work. Pile construction shall be at locations, dimensions and lengths indicated in the Drawings.

The Contractor shall furnish the piles in accordance with an itemized list, which will be provided by the Engineer, showing the number and lengths of all piles. When the cast-in-place concrete piles are specified in the Plans, the Engineer will not furnish the Contractor an itemized list showing the number and lengths of piles. When test piles and load test are required in conformance with Subsection 400.1.2 and 400.1.3, respectively, the data obtained from driving test piles and making test loads will be used in conjunction with other available subsoil information to determine the number and lengths of piles to be furnished. The Engineer will not prepare the itemized list of piles for any portion of the foundation area until all specified loading tests in the Contract representative of the portion have been completed.

400.1.1.1 Working Drawings

At least four (4) weeks prior to bored piling activities, the Contractor shall submit to the Engineer for approval a construction methodology for such construction of bored piles. The submittals shall include the following:

- a) List of proposed equipment to be used including cranes, drills, augers, bailing buckets, final cleaning equipment, desanding equipment, slurry pumps, sampling equipment, tremies or concrete pumps, casings, etc.
- b) Details of overall construction operation sequence of bored pile construction in bents or groups or singly.
- c) Details of pile excavation method.
- d) When slurry is required, details of the method, proposed mix, circulation and design of slurry.
- e) Details of methods to clean the pile excavation.
- f) Details of reinforcement placement including support and centralization methods.
- g) Details of concrete placement, curing and protection.
- h) Details of any required Load Tests (if called for in the Drawings) and;
- i) Other information shown on the Drawings or requested by the Engineer.

The Contractor shall not start construction of bored pile for which working drawings are required until the Engineer has approved such drawings.

obtained by use of these drawings or any of this other responsibilities under the Contract.

400.1.2 Test Piles

For his reference, the Contractor may drive the test piles at the location of the regular piles indicated on the Plans such test piles as he may consider necessary in addition to the test piles specified in the Contract and shall be considered as regular piles. When called for in the Bill of Quantities, a pile if required to be subjected to load test shall conform to the provision as provided in Subsection 400.1.3, Load Tests.

The Contractor shall furnish and drive the test piles of the dimensions and at the locations designated by the Engineer. They shall be of the material shown in the Bill of Quantities and shall be driven to refusal or to such tip elevation or approximate bearing value as the Engineer may request. Test Piles shall be driven with the same hammer that is used for driving foundation Piles.

400.1.3 Load Tests

Load tests for the piles shall be either Static or Pile Testing by Low-Strain Dynamic Method, High-Strain Dynamic Method and Cross-Hole Sonic Logging of Bored Holes.

When load tests are specified, the number and location of piles to be tested will be designated by the Engineer. Load tests shall be done by methods approved by the Engineer. The Contractor shall submit to the Engineer for approval a detailed plans of the loading apparatus he intends to use. The apparatus shall be so constructed as to allow various increments of the load to be placed gradually without causing vibration to the test piles. If the approved method requires the use of tension (anchor) piles, such tension piles shall be of the same type and diameter as the permanent piles and shall be driven in the location of the permanent piles when feasible. Piling not a part of the structure shall be removed or cut off at least 300mm below the bottom of the footing or finished elevation of the ground upon completion of the test load. Permanent piling used as anchor piling which is raised during the test load shall be redriven to original grade and bearing.

400.1.3.1 Static Testing

Suitable approved apparatus for determining accurately the load on the pile and the settlement of the pile under increment of load shall be supplied by the Contractor.

Test loading shall consist of the application of incremental static loads to a pile and measuring the resultant settlement. The load static shall be applied by a hydraulic jack acting against suitable anchorage, transmitting the load directly to the pile, or other methods designated by the Plans or approved by the Engineer.

400.1.3.2 Pile Testing

Pile testing shall be done by Low-Strain Dynamic Method, High-Strain Dynamic Method or Cross-Hole Sonic Logging Method as required in

Dynamic Method or Cross-Hole Sonic Logging Method as required in the Plans or as directed by the Engineer.

400.1.3.2.1 Low-Strain Dynamic Method

Pile integrity testing by Low-Strain Dynamic method shall conform to ASTM D-5882. It is a so called Low Strain method, since it requires the impact of only a small hand-held hammer, and also referred to as a Non-Destructive Method.

400.1.3.2.2 High-Strain Dynamic Method

Pile integrity testing by High-Strain Dynamic Method shall conform to ASTM D4945. High-Strain Dynamic Method shall be applied to confirm the design parameters and capacities assumed for the piles as well as to confirm the normal integrity of testing of the piles. It is considered supplemental to the low-strain and the sonic-type integrity testing of the cast-in-place piles. It is non-destructive relatively quick test and it is intended that the test shaft be left in a condition suitable for the use in production. The shaft used for the test will be instrumented and tested by the testing specialist, as approved by the Engineer, meeting requirements in accordance to ASTM D 4945.

400.1.3.2.3 Cross-Hole Logging of Bored Holes Method

This is done by sending ultrasonic pulses through the concrete from one probe to another (probes located in parallel tubes), the Cross-Hole Sonic Logging (CSL) procedure inspects the drilled shafts structural integrity, and extent and location of defects, if any. At the receiver probe, pulse arrival time and signal the concrete affects strength. For equidistant tubes, uniform concrete yields consistent arrival times with reasonable pulse wave speed and signal strengths. Non-uniformities such as contamination, soft concrete, honeycombing, voids, or intrusions of foreign objects exhibit delayed arrival time with reduced signal strength.

400.1.4 Concrete and Steel Pile Bearing Values

The bearing values for concrete and steel pile will be determined by the Engineer using the following formulas:

- a. Modified Hiley's Formula or any formula from brochures of the equipment used shall be used when the ratio of weight of ram or hammer to weight of pile is greater than one fourth (1/4).

$$R_u = \frac{2WH (W)}{(S+K) (W+W_p)}$$

$$R_a = \frac{R_u}{FS}$$

where:

Ru	=	ultimate capacity of piles (KN)
Ra	=	capacity of pile (KN)–shall be greater than the required weight of ram or hammer
W	=	(KN)
H	=	height of fall of ram (mm)
Wp	=	weight of pile (KN)
S	=	average penetration for the last ten blows (mm)
K	=	10 mm (unless otherwise observed/computed during driving)
FS	=	factor of safety (min. = 3)

- b. Hiley's Formula shall be used when the ratio of the weight of ram or hammer to weight of pile is less than one fourth (1/4).

$$R_u = \frac{efWH (W)}{S+1/2 (C_1+C_2+C_3)} \times \frac{(W + n^2 W_p)}{(W + W_p)}$$

$$R_a = \frac{R_u}{FS}$$

where:

Ru	=	ultimate capacity of pile (KN)
Ra	=	capacity of pile (KN)
ef	=	efficiency of hammer (refer to table)
W	=	weight of ram (KN)
Wp	=	weight of pile (KN)
H	=	height of fall of ram (mm)
S	=	average penetration for last ten blows (mm)
C1	=	temporary compression allowance for pile head and cap (refer to table)
C2	=	RuL/AEp
C3	=	range from 2.54mm to 5.08mm (0.1" to 0.2") for resilient soil to 0 for hard pan (rock, very dense sand and gravel)
L	=	length of pile
A	=	cross-sectional area of pile
Ep	=	modulus of elasticity of pile
n	=	coefficient of restitution (refer to table)
FS	=	factor of safety (min. = 3)

Required minimum penetration of all piles shall be six (6) meters. However, for exposed piles, the embedded length shall be equal or greater than the exposed length but not less than 6.0m.

Note: Formula for other pile hammers with suggested factor of safety should be as provided/recommended by their respective manufacturer. In all cases when the bearing power of concrete and steel piles is determined by formula, the piles shall be driven until the safe bearing power of each is computed to be not less than 27 tons..

400.1.5 Safe Loads

When the safe bearing power of any pile is found by test or computation to be less than the design load, longer piles or additional piles shall be driven as ordered in writing by the Engineer.

400.1.6 Jetted Piles

The safe bearing power of jetted piles shall be determined by actual tests or by the appropriate methods and formulas given in the preceding Subsections. No jet shall be used during the test blows.

400.2 Material Requirements

The kind and type of piles shall be as specified on the Plans and Bill of Quantities. No alternative type or kind of piling shall be used.

400.2.1 Concrete Piles

Cast in place concrete materials for bored piles shall conform to the requirements of Item 405, Structural Concrete. Concrete shall be Class "AA1" with strength requirement of 28 Mpa (4,000psi), unless otherwise specified in the Plans.

Concrete shall be proportioned to achieved a range of 6" to 8" (150mm to 200mm) slump, self-compacting mix, or as directed by the Engineer.

The use of appropriate plasticizer/additives to assure mix fluidity and consistency shall be allowed and with the Engineer's approval. A retardant of proven adequacy and approved by the Engineer may be used to ensure that early hardening of concrete during operation will not occur.

Reinforcing steel shall conform to the requirements of Item 404, Reinforcing Steel. Prestressing reinforcing steel shall be high-tensile steel wire conforming to AASHTO M 204 or other high-tensile metals conforming to AASHTO Standards.

Casings which are required to be incorporated as part of permanent work shall conform to AASHTO M183 (ASTM A-36) or JIS G3114 (SMA 400W).

400.2.2 Steel Shells**1. Shells Driven Without a Mandrel**

Unless otherwise called for on the Plans or Special Provisions, shells for cast-in-place concrete piles shall have a minimum 305mm diameter at cut off and a minimum 203mm diameter at tip: made from not less than 4.55mm in thickness plate stock conforming to AASHTO M 183. Shells may either be spirally welded or longitudinally welded and may either be tapered or constant in section. Tips shall be sealed as shown on the Plans.

2. Shells Driven With a Mandrel

The shell shall be of sufficient strength and thickness to withstand driving without injury and to resist harmful distortion and/or buckling due to soil pressure after driven and the mandrel removed. Butt and tip dimension shall be as called for on the Plans or Special Provisions.

400.2.3 Steel Pipes

Filled Steel Pipes (filled with concrete) shall conform to the requirements of ASTM A 252, Grade 2, Welded and Seamless Pipe Piles. Closure

Plates for closed piles shall conform to the requirements of AASHTO M 183.

Unfilled Tubular Steel Piles shall conform to the requirements of ASTM A 252, Grade 2, with chemical requirements meeting ASTM Designation A 53, Grade B. The wall thickness shall not be less than 4.76mm.

400.2.4 Steel H-Piles

Steel H-Piles shall be rolled steel sections of the weight and shape called for on the Plans. They shall be structural steel meeting the requirements of AASHTO M 183 provided that, where the Special Provisions called for copper-bearing structural steel, the steel shall not contain less than one-fifth percent nor more than zero point thirty five percent (0.35%) of copper, except that steel manufactured by the acid-Bessemer process shall not be used.

400.2.5 Sheet Piles

Steel sheet piles shall meet the requirements of AASHTO M 202 (ASTM A 328), or AASHTO M 223. All other sheet piles shall meet the requirements prescribed above the particular material specified. The joints shall be practically watertight when the piles are in place.

400.2.6 Pile Shoes

Pile shoes shall be as called for on the Plans.

400.2.7 Splices

Material for pile splices, when splicing is allowed, shall be of the same quality as the material used for the pile itself and shall follow the requirements given on the Plans.

400.2.8 Paint

It shall conform to Item 411, Paint.

400.3 Construction Requirements

400.3.1 Location and Site Preparation

Piles shall be driven where indicated on the Plans or as directed by the Engineer.

All excavations for the foundation on which the piles are to be driven shall be completed before the pile driving, unless otherwise specified or approved by the Engineer. After driving is completed, all loose and displaced materials shall be removed from around the piles by hand excavation, leaving clean solid surface to receive the concrete of the foundation. Any requirement for granular fill and lean concrete shall be indicated on the Plans or as directed by the Engineer.

400.3.2 Determination of Pile Length

Pile length and bearing capacity shall be determined by the Engineer from the results of the test piling and load tests.

The criterion for pile length may be one of the following:

1. Piles in sand and gravel shall be driven to a bearing power determined by the use of the pile driving formula or as decided by the Engineer.
2. Piles in clay shall be driven to the depth ordered by the Engineer. However, the bearing power shall be controlled by the pile driving formula if called for by the Engineer.
3. Piles shall be driven to refusal on rock or hard layer when so ordered by the Engineer.

The Contractor shall be responsible for obtaining the correct pile length and bearing capacity according to the criteria given by the Engineer.

400.3.3 Pile Driving

All piles shall be driven as shown on the Plans or as ordered in writing by the Engineer. They shall be driven within an allowed variation of 20mm per meter of pile length from the vertical or batter as shown on the Plans. The maximum allowable variation at the butt end of the pile shall be 75mm in any direction from the location shown on the Plans or as directed by the Engineer. Each pile shall, after driving, be within 150mm from the theoretical location underneath the pile cap or underneath the superstructure in case of pile bents. All piles pushed up by the driving of adjacent piles or any other cause shall be redriven.

Piles shall be used only in places where the minimum penetration of 3m in firm materials, or 5m in soft materials can be obtained. Whereas soft upper stratum overlies a hard stratum, the piles shall penetrate the hard materials at sufficient depths to fix the ends rigidly.

All pile driving equipment is subject to the Engineer's approval. The Contractor is responsible for sufficient weight and efficiency of the hammers to drive the piles down to the required depth and bearing capacity. Hammers shall be gravity hammers, single and double acting steam or pneumatic hammers or diesel hammers. Gravity hammers shall not weigh less than 60 percent of the combined weight of the pile and driving head but not less than 2,000 kg. The fall shall be regulated so as to avoid injury to the pile and shall in no case exceed 4.50m for timber and steel piles and 2.50m for concrete piles unless otherwise specified or approved by the Engineer.

The plant and equipment furnished for steam hammers shall have sufficient capacity to maintain, under working condition, the pressure at the hammer specified by the manufacturer. The boiler or pressure tank shall be equipped with an accurate pressure gauge and another gauge shall be supplied at the hammer intake to determine the drop in pressure between the gauges. When diesel hammers or any other types requiring calibration are used, they shall be calibrated with test piling and/or test loads in accordance with Subsection 400.1.2, Test Piles.

Water jets shall be used only when permitted in writing by the Engineer. When water jets are used, the number of jets and the nozzle volume and pressure shall be sufficient to erode freely the material adjacent to the pile. The plant shall have sufficient capacity to deliver at all time a pressure equivalent to at least 690 KPa at two 19 mm (3/4 inch) jet nozzles. The jets

shall be shut off before the required penetration is reached and the piles shall be driven solely by hammers to final penetration as required by the Engineer.

Piles shall be supported in line and position with leads while being driven. Pile driving leads shall be constructed in such a manner as to afford freedom of movement of the hammer, and shall be held in position by guys or steel braces to insure rigid lateral support to the pile during driving. The leads shall be of sufficient length to make the use of a follower unnecessary and shall be so designed as to permit proper placing of batter piles. The driving of the piles with followers shall be avoided if practicable and shall be done only under written permission from the Engineer.

The method used in driving piles shall not subject them to excessive and undue abuse producing crushing and spalling of the concrete, injurious splitting, splintering and brooming of the wood or deformation of the steel. Manipulation of piles to force them into proper position if considered by the Engineer too excessive will not be permitted.

The pile tops shall be protected by driving heads, caps or cushions in accordance with the recommendation of the manufacturer of the pile hammer and to the satisfaction of the Engineer. The driving head shall be provided to maintain the axis of the pile with the axis of the hammer and provide a driving surface normal to the pile.

Full-length piles shall be used where practicable. Splicing of piles when permitted, shall be in accordance with the provisions of Subsection 400.3.7 and 400.3.8. All piles shall be continuously driven unless otherwise allowed by the Engineer.

Piles shall not be driven within 7 m of concrete less than 7 days old.

400.3.4 Precast Concrete Piles

Precast concrete piles shall be of the design shown on the Plans. Prestressed concrete piles shall be prestressed as prescribed in Item 406, Prestressed Concrete Structures.

The piles shall be cast separately and concrete in each pile shall be placed continuously. The completed piles shall be free from stone pockets, honeycombs, or other defects, and shall be straight and true to the form specified. The forms shall be true to line and built of metal, plywood or dressed lumber. A 25mm chamfer strip shall be used in all corners. Form shall be watertight and shall not be removed until at least twenty-four (24) hours after the concrete is placed.

Piles shall be cured and finished in accordance with Items 405, Structural Concrete and 406, Prestressed Concrete Structures.

Cylinder specimens shall be made and tested in accordance with Item 405. Piles shall not be moved until the tests indicate that the concrete has attained a compressive strength of at least 80 percent (80%) of the design 28-day compressive strength and they shall not be transported or driven until the design 28-day compressive strength has been attained.

If testing equipment is not available, as in isolated areas, piles shall not be moved until after fourteen (14) days after casting and shall not be transported

or driven prior to 28 days after casting. If high early strength cement is used, piles shall not be moved, transported or driven prior to 7 days after casting.

When concrete piles are lifted or moved, they shall be supported at the points shown on the Plans; if not shown, they shall be supported at the quarter points.

400.3.5 Cast-in-place Concrete Piles

1. Drilled Holes

All holes for concrete piles cast in drilled holes shall be drilled dry to tip elevation shown on the Plans. All holes will be examined for straightness and any hole, which on visual inspection from the top shows less than one-half the diameter of the hole at the bottom of the hole will be rejected. Suitable casings shall be furnished and placed when required to prevent caving of the hole before concrete is placed.

All loose material existing at the bottom of the hole after drilling operations have been completed shall be removed before placing concrete.

The use of water for drilling operations or for any other purpose where it may enter the hole will not be permitted. All necessary action shall be taken to prevent surface water from entering the hole and all water which may have infiltrated into the hole shall be removed before placing concrete.

Concrete shall be placed by means of suitable tubes. Prior to the initial concrete set, the top 3m of the concrete filled pile or the depth of any reinforcing cage, whichever is greater, shall be consolidated by acceptable vibratory equipment,

Casing, if used in drilling operations, may be left in place or removed from the hole as concrete is placed. The bottom of the casing shall be maintained not more than 1.5m nor less than 0.3m below the top of the concrete during withdrawal and placing operations unless otherwise permitted by the Engineer. Separation of the concrete during withdrawal operations shall be avoided by vibrating the casing.

2. Steel Shells and Pipes

The inside of shells and pipes shall be cleaned and all loose materials removed before concrete is placed. The concrete shall be placed in one continuous operation from tip to cut-off elevation and shall be carried on in such a manner as to avoid segregation.

The top 3 meters of concrete filled shells, or to the depth of any reinforcing cage, whichever is greater, shall be consolidated by acceptable vibratory equipment.

Pipes shall be of the diameter shown on the Plans. The pipe wall thickness shall not be less than that shown on the Plans but in no case less than 5mm. The pipe, including end closures, shall be of sufficient strength to be driven by the specified methods without distortion.

Closure plates and connecting welds shall not project more than 12.5 mm beyond the perimeter of the pile tips.

No shell or pipe shall be filled with concrete until all adjacent shells, pipes, or piles within a radius of 1.5m or 4 ½ times the average pile diameter, whichever is greater, have been driven to the required resistance.

After a shell or pipe has been filled with concrete, no shell, pipe or pile shall be driven within 6m thereof until at least 7 days have elapsed.

3. Drilled Shafts

Drilled shafts are deep foundations formed by boring a cylindrical hole into soil and/or rock and filling the hole with concrete. Drilled shafts are also commonly referred to as caissons, bored piles or drilled piers.

Drilled shafts, like driven piles, transfer structural loads to bearing stratum well below the base of the structure by passing soils having insufficient strength to carry the design loads.

Drilled shafts are classified according to their primary mechanism for deriving load resistance either as floating shafts (i.e., shafts transferring load primarily by side resistance), or end-bearing shafts (i.e., shafts transferring load primarily by tip resistance). Occasionally, the bases of shafts are enlarged (i.e., belled or under reamed) to improve the load capacity of end bearing shafts on less than desirable soils, or to increase the uplift resistance of floating shafts.

Effects of ground and ground water conditions on shaft construction operations should be considered and delineated, when necessary, the general method of construction to be followed to ensure the expected performance. Because shafts derive their capacity from side and tip resistance, which are a function of the condition of the materials in direct contact with the shaft, it is important that the construction procedures be consistent with the material conditions assumed in the design. Softening, loosening or other changes in soil and rock conditions caused by the construction method could result in a reduction in shaft capacity and an increase in shaft displacement. Therefore, evaluation of the effects of shaft construction procedure on load capacity must be considered an inherent aspect of the design.

Drilled shafts are normally sized in 15.24 cm (6-inch diameter increments with a minimum diameter of 45.72 cm (18"). The diameter of a shaft socketed into rock should be a minimum of 15.24 cm (6") larger than the socket diameter. If a shaft must be inspected by the entry of a person, the shaft diameter shall not be less than 76.20 cm (30").

Drilled shafts constructed in dry noncaving soils can usually be excavated without lateral support of the hole. Other ground conditions where caving, squeezing or sloughing soils are present require installation of a steel casing or use of a slurry for support of the hole. Such conditions and techniques may result in loosening of soil around the shaft, or altering of frictional resistance between the concrete shaft and surrounding soil.

The center-to-center spacing between shafts is normally restricted to a minimum of 3B to minimize the effects of interaction between adjacent shafts during construction or in service. However, larger spacing may be required where drilling operations are difficult or where construction must be completed in very short time frames.

Particular attention should be given to the potential for deposition of loose or wet material in the bottom of the hole, or the buildup of a cake of soft material around the shaft perimeter prior to concrete placement. Adequate cleaning and inspection of rock sockets should always be performed to assure good contact between the rock and shaft concrete. If good contact along the shaft cannot be confirmed, it may be necessary to assume that all load is transferred to the tip. If the deposition of soft or loose material in the bottom of the hole is expected, the shaft may have to be designed to carry the entire design load through side resistance.

A number of methods can be used to prevent caving during the drilling of holes and the placement of concrete. It is preferred that drilled shafts be constructed in stable non-sloughing soil without excessive ground water. If impossible, consider the following three different construction methods:

- a) construction of the pile or shaft in a wet condition while the walls of the excavation are stabilized by hydrostatic pressure of water or mineral slurry until the concrete is placed by tremie methods for the full length of the pile.

Mineral slurry used in the drilling process shall have both a mineral grain size that will remain in suspension and sufficient viscosity and gel characteristics to transport excavated material to a suitable screening system. The percentage and specific gravity of the material used to make the suspension shall be sufficient to maintain the stability of the excavation and to allow proper concrete placement. The level of the slurry shall be maintained at a height sufficient to prevent caving of the hole.

The mineral slurry shall be premixed thoroughly with clean fresh water and adequate time allotted for hydration prior to introduction into the shaft excavation. Adequate slurry tanks will be required when specified. No excavated slurry pits will be allowed when slurry tanks are required on the project without written permission of the Engineer. Adequate desanding equipment will be required when specified. Steps shall be taken as necessary to prevent the slurry from "setting up" in the shaft excavation, such as agitation, circulation, and adjusting the properties of the slurry.

Control tests using suitable apparatus shall be carried out by the Contractor on the mineral slurry to determine density, viscosity, and pH. An acceptable range of values for those physical properties is shown in the following table.

Range of Values (At 20° or [68°F])

Property (Units)	Time of Slurry Introduction	Time of Concreting (In Hole)	Test Method
Density (KN/m ³) (pcf)	10.10 to 10.86 64.3 to 69.1	10.10 to 11.79 64.3 to 75.0	Density Balance
Viscosity (sec. per quart)	28 to 45	28 to 45	Marsh Cone
pH	8 to 11	8 to 11	pH Paper or Meter

Note:

- 1) Increase density values by 0.314 KN/m^3 (2 pcf) in salt water.
- 2) If desanding is required; sand content shall not exceed 4 percent (by volume) at any point in the shaft excavation as determined by the American Petroleum Institute sand content test.

Tests to determine density, viscosity and pH values shall be done during the shaft excavation to establish a consistent working pattern.

Prior to placing shaft concrete, slurry samples shall be taken from the bottom and at intervals not exceeding 3.05m (10 feet) for the full height of slurry. Any heavily contaminated slurry that has accumulated at the bottom of the shaft shall be eliminated. The mineral slurry shall be within specification requirements immediately before shaft concrete placement.

Excavation Inspection

The Contractor shall provide equipment for checking the dimensions and alignment of each shaft excavation. The Contractor under the direction of the Engineer shall determine the dimensions and alignment of the drilled shaft. Final shaft depth shall be measured after final cleaning.

The base of the shaft excavation may be cleaned using a cleaning bucket followed by airlifting. Reverse circulation techniques may also be used to clean the base of the shaft.

The shaft excavation shall be cleaned so that a minimum of 50 percent of the base will have less than 12.5 mm of sediment and at no place on the base more than 37.5 mm of sediment. The Engineer will determine shaft cleanliness.

- b) The use of steel casing, which is installed during drilling operations to hold the hole open and usually withdrawn during concrete placement.

Casing, if used in operation, shall be metal, smooth, clean, watertight, and of ample strength to withstand both handling and driving stresses and the pressure of both concrete and the surrounding earth materials. The outside diameter of casing shall not be less than the specified size of the shaft. It shall conform to AASHTO M 270 (ASTM A 709) Grade 36 unless otherwise specified.

Temporary casings shall be removed while the concrete remains workable. Generally the removal of temporary casing shall not be started until concrete placement in the shaft is at or above ground surface. Movement of casing by rotating, exerting downward pressure and tapping to facilitate extraction or extraction with a vibratory hammer will be permitted. Casing extraction shall be at a slow, uniform rate with the pull in line with the shaft axis.

A sufficient head of concrete shall be maintained above the bottom of the casing to overcome the hydrostatic pressure of water or drilling fluid outside of the casing.

- c) The use of a permanent casing, which is left in place within the portion of the pile, which is in unstable material.

A permanent casing is applied as protection from the presence of surface water during drilling and as support later for the installation of the rebar cage and as a concrete form in drilling under water.

Reinforcing Steel Cage Construction and Placement

The reinforcing steel cage consisting of the steel shown on the Plans plus cage stiffener bars, spacers, centralizers and any other necessary appurtenances shall be completely assembled and placed as a unit immediately after the shaft excavation is inspected and accepted and prior to shaft concrete placement.

Where the reinforcing cage length is too long for placement as a single unit the cage may be placed in separate units such that appropriate means of splicing the longitudinal steel is provided for. The Contractor shall submit his plans for such splices to the Engineer for approval.

The reinforcing steel in the hole shall be tied and supported so that the reinforcing steel will remain within allowable tolerances until the concrete will support the reinforcing steel. When concrete is placed by suitable tubes, temporary hold-down devices shall be used to prevent uplifting of the steel cage during concrete placement. Concrete spacers or other approved non-corrosive spacing devices shall be used at sufficient intervals not exceeding 1.50 meters along the shaft to insure concentric location of the cage within the shaft excavation. When the size of the longitudinal reinforcing steel exceeds 25mm, such spacing shall not exceed 3.0 meters.

Concrete Placement, Curing and Protection

Concrete shall be placed as soon as possible after reinforcing steel cage placement. Concrete placement shall be continuous in the shaft to the top elevation of the shaft. Placement shall continue after the shaft is full until good quality concrete is evident at the top of the shaft. Concrete shall be placed through a suitable tube.

For piles less than 2.5 meters in diameter, the elapsed time from the beginning of concrete placement in the shaft to the completion of placement shall not exceed 2 hours. For piles 2.50 meters and greater in diameter, the concrete placing rate shall not be less than 9.0 meters of pile height per each 2-hour period. The concrete mix shall be of such design that the concrete remains in a workable plastic state throughout the 2-hour placement limit.

When the top of pile elevation is above ground, the portion of the pile above ground shall be formed with a removable form or permanent casing when specified.

The upper 1.5 meters of concrete shall be vibrated or rodded to a depth of 1.5 meter below the ground surface except where soft uncased soil or slurry remaining in the excavation will possibly mix with the concrete.

After placement, the temporarily exposed surfaces of the shaft concrete shall be cured in accordance with the provision in Sub-section 407.3.8 – Curing Concrete.

For at least 48 hours after pile concrete has been placed, no construction operations that would cause soil movement adjacent to the shaft, other than mild vibration, shall be conducted.

Construction Tolerances:

The following tolerances shall be maintained in constructing drilled shaft;

- a. The drilled shaft shall be within 15.24 cm of the plan position in the horizontal plane at the plan elevation for the top of the shaft.
- b. The vertical alignment of the shaft excavation shall not vary from the plan alignment by more than 20.83 mm/m (1/4 inch per foot) of depth.
- c. After the shaft concrete is placed, the top of the reinforcing steel cage shall be no more than 15.24 cm above and no more than 15.24 cm above and no more than 7.62 cm below plan position.
- d. When casing is used, its outside diameter shall not be less than the shaft diameter shown on the plans. When casing is not used, the minimum diameter of the drilled shaft shall be the diameter shown on the plans for diameters 60.96 cm (24") or less, and not more than 2.54 cm (1 inch) less than the diameter shown on the plans for diameters greater than 60.96 cm (24").
- e. The bearing area of bells shall be excavated to the plan bearing area as a minimum. All other plan dimensions shown for the bells may be varied, when approved, to accommodate the equipment used.
- f. The top elevation of the shaft shall be within 2.54 cm (1 inch) of the plan top of shaft elevation.
- g. The bottom of the shaft excavation shall be normal to the axis of the shaft within 62.5 mm/m (3/4 inch per foot) of shaft diameter.

Drilled shaft excavations constructed in such a manner that the concrete shaft cannot be completed within the required tolerances are unacceptable.

400.3.6 Steel H-Pile

Steel H-Pile shall consist of structural steel shapes of the sections indicated on the Plans.

When placed in the leads, the pile shall not exceed the camber and sweep permitted by allowable mill tolerance. Piles bent or otherwise damaged will be rejected.

The loading, transporting, unloading, storing and handling of steel H-pile shall be conducted so that the metal will be kept clean and free from damage.

400.3.7 Unfilled Tubular Steel Piles

The tubular steel piles should be or as specified by the Engineer.

The minimum wall thickness shall be as indicated in the following table

Outside Diameter	Less than 355 mm	355 mm and over
Minimum wall thickness	6.5mm	9.5mm

6.5.1 Splicing

Splicing when permitted shall be made as shown on the Plans and in accordance with this Subsection.

1. Precast Concrete Piles

- a. By using prefabricated joints mounted in the forms and cast together with the piles sections and joined together as specified by the manufacturer and approved by the Engineer. The joints shall be of the design and type as specified or shown on the Plans.
- b. By cutting away the concrete at the end of the pile, leaving the reinforcing steel exposed for a length of 40 bar diameters for corrugated or deformed bars and 60 bar diameters for plain bars. The final cut of the concrete shall be perpendicular to the axis of the pile. Reinforcement of the same size as that used in the pile shall be spliced to the projecting steel in accordance with Item 404, Reinforcing Steel, and the necessary formwork shall be placed, care being taken to prevent leakage along the pile. The concrete shall be of the same quality as that used in the pile. Just prior to placing concrete, the top of the pile shall be wetted thoroughly and covered with a thin coating of neat cement, retempered mortar, or other suitable bonding material to the satisfaction of the Engineer. The forms shall remain in place not less than seven (7) days. The pile shall not be driven until the safe design has been reached.
- c. By any other method shown on the Plans or approved by the Engineer. Curing and finishing of extensions shall be the same as in the original pile.

2. Pre-stressed Piles

Splicing of pre-stressed precast piles will generally not be permitted, but when permitted, it shall be made in accordance with (1) above, but only after driving has been completed. Reinforcement bars shall be included in the pile head for splicing to the extension bars. No additional driving will be permitted. The Contractor, at his option, may submit alternative plans of splicing for consideration by the Engineer.

3. Steel Piles, Shells or Pipes

If the length of the steel pile, shell or pipe driven is insufficient to obtain the specified bearing power, an extension of the same cross-section shall be spliced to it. Unless otherwise shown on the Plans, splices shall be made by butt-welding the entire cross-sections to form an integral pile using the electric arc method. The sections connected shall be properly aligned so that the axis of the pile shall be straight. Bent and/or damaged piles shall be rejected.

400.3.9 Cutting Off and Capping Piles

The top of foundation piles shall be embedded in the concrete footing as shown on the Plans.

Concrete piles shall, when approved by the Engineer, be cut off at such a level that at least 300mm of undamaged pile can be embedded in the structure above. If a pile is damaged below this level, the Contractor shall repair the pile to the satisfaction of the Engineer. The longitudinal reinforcement of the piles shall be embedded in the structure above to a length equal to at least 40 times the diameter of the main reinforcing corrugated bars (60 diameters for plain bars). The distance from the side of any pile to the nearest edge of the cap shall not be less than 200mm.

When the cut off elevation for a precast pile or for the steel shell or pile for a cast in place concrete pile is below the elevation of the bottom of the pile cap, the pile may be built-up from the butt of the pile to the elevation of the bottom of the cap by means of reinforced concrete extension constructed in accordance with Subsection 400.3.8 or as approved by the Engineer.

Cut-offs of structural steel piles shall be made at right angles to the axis of the pile. cuts shall be made in clear, straight lines and any irregularity due to cutting or burning shall be leveled-off with deposits of weld metal prior to placing bearing caps.

400.3.10 Defective Piles

Any pile delivered with defects, or damaged in driving due to internal defects or by improper driving, or driven out of its proper location, or driven below the elevation fixed by the Plans or by the Engineer, shall be corrected at the Contractor's expense by one of the following methods approved by the Engineer for the pile in question:

1. Any pile delivered with defects shall be replaced by a new pile.
2. Additional pile shall be driven/casted at the location as directed by the Engineer.
3. The pile shall be spliced or built-up as otherwise provided herein on the underside of the footing lowered to properly embed the pile.

A precast concrete pile shall be considered defective if it has a visible crack, extending around the four sides of the pile, or any defect which, in the opinion of the Engineer, affects the strength or life of the pile.

When a new pile is driven or cast to replace a rejected one, the Contractor at his own expense, shall enlarge the footing as deemed necessary by the Engineer.

400.3.11 Painting Steel Piles

Unless otherwise provided, when required steel piles extend above the ground surface or water surface, they shall be protected by paint as specified for cleaning and painting metal surfaces in accordance with Item 403, Metal Structures. This protection shall extend from the elevation shown on the Plans to the top of the exposed steel.

400.3.12 Pile Records

The Contractor shall keep records of all piles driven or installed. A copy of the record shall be given to the Engineer within two (2) days after each pile is driven. The record form to be used shall be approved by the Engineer. The pile records shall give full information on the following :

Driven Piles	Cast-in-Place Piles
1. Pile type and dimension	1. Date of boring or driving (For steel shell) & casting
2. Date of casting and concrete quality (for concrete piles)	2. Pile type and nominal dimension
3. Date of driving	3. Length of finished pile and tip elevation
4. Driving equipment: type, weight & efficiency of hammer, etc.	4. Details of penetration during boring or driving of steel shell(diving records as for driven piles)
5. Description of cushion on pile head	5. Concrete quality and consistency
6. Depth driven and tip elevation	6. Time interval between boring or driving and concreting
7. Final set for the last 20 blows (for every 10 piles and when the Engineer so requires the penetration along the whole depth driven shall be recorded)	7. Volume of concrete placed in concrete
8. For gravity and single-acting hammers: the height of drop	
9. For double acting-hammers --- the frequency of blows	
10. Details of any interruption in driving	
11. Level of pile top immediately after driving and the level when all piles in the group are driven	
12. Details of re-driving	

400.4 Method of Measurement**400.4.1 Timber, Steel and Precast Concrete Piles**

1. Piles Furnished

The quantity to be paid for will be the sum of the lengths in meters of the piles of several types and lengths ordered in writing by the Engineer, furnished in compliance with these Specifications and stockpiled in good condition at the project site by the Contractor and accepted by the Engineer. The length to be paid for will include test and tension piles ordered by the Engineer, but not those furnished by the Contractor at his option. No allowance will be made for piles, including test piles, furnished by the Contractor to replace piles previously accepted by the Engineer that are subsequently lost or damaged while in stockpile, or during handling or driving, and are ordered by the Engineer to be removed from the site work.

In case extensions of piles are necessary, the extension length will be included in the length of pile furnished, except for cut of length used for extensions and measured for payment.

2. Piles Driven

The quantity to be paid for will be the sum of the lengths in meters of the piles driven in the completed work measured from the pile tip elevation to the bottom of the pile caps, footings or bottom of concrete superstructure in the case of pile bents. Measurement will not include additional piles or test piles driven that maybe necessary to suit the Contractor's method of construction and were driven at his option. Unless otherwise provided for, preboring, jetting or other methods used for facilitating pile driving operations will not be measured directly but will be considered subsidiary to Pay Items.

400.5 Basis of Payment

The accepted quantities, measured as prescribed in Section 400.4 shall be paid for at the contract unit price for each of the particular item listed below that is included in the Bill of Quantities. Price and payment shall be full compensation for furnishing and placing of the all materials, including all labor, equipment tools and incidentals as well as temporary works, staging areas or crane-way necessary to complete the work prescribed in this Item.

Payment will be made under:

Pay Item Number	Description	Unit of Measurement
400 (23)a7	Concrete Bored Piles Cast in Place, (1.40m diameter)	Meter
400 (23)a9	Concrete Bored Piles Cast in Place, (1.60m diameter)	Meter
400 (23)a13	Concrete Bored Piles Cast in Place, (2.00m diameter)	Meter
400 (23)a19	Concrete Bored Piles Cast in Place, (2.60m diameter)	Meter
400 (23)a21	Concrete Bored Piles Cast in Place, (2.80m diameter)	Meter

400 (24)g1	Permanent Casing, (1.40m dia x 10mm thick)	Meter
400 (24)i1	Permanent Casing, (1.60m dia x 12mm thick)	Meter
400 (24)m1	Permanent Casing, (2.0m dia. x 12mm thick)	Meter
400 (24)s1	Permanent Casing, (2.60m dia. x 16mm thick)	Meter
400 (24)u1	Permanent Casing, (2.80m dia. x 16mm thick)	Meter

ITEM 400(27)a PILE INTEGRITY TESTING**400(27)a.1 Integrity Testing**

The completed bored pile shall be subjected to non-destructive testing to determine the extent of any defects that may be present in the pile. Integrity-testing method to be adopted shall be low-strain, by either the Pulse Echo Method (PEM) or Transient Response Method (TRM) in accordance with ASTM D 5882, subject to the approval of the Engineer.

The testing shall be carried out by the material engineer of the Contractor with specialized experience in this field and shall be approved by the Engineer. Prior to integrity testing, all apparatus shall be calibrated to ensure that precise and reliable data will be obtained. Certificate of calibration shall be submitted by the Contractor unless otherwise waived by the Engineer.

400(27)a.2 Report

The Contractor shall submit a report on the integrity testing containing vital information necessary for the pile evaluation, prescribed in ASTM D5882. Such report shall be submitted within seven days after the completion of each test.

400(27)a.3 Final Integrity Evaluation

If and when necessary as determined after evaluation of the integrity of the pile subjected to the test, the Engineer may require further test or dictate pile repair or replacement, depending on the seriousness of the defect that may be established

For piles that need to be repaired, the Contractor shall submit for approval of the Engineer, remedial measures he intends to implement.

For rejected piles, the Contractor shall make a proposal for review and approval of the Engineer. Such proposal shall include the necessary design calculations, the methodology he intends to implement, equipment and other items as may be necessary. Approval of these proposals however does not relieve the Contractor of his contractual responsibilities for any defects as a result of the proposals. The cost of further tests required, remedial measures and replacement of rejected piles shall be borne by the Contractor.

400(27)a.4 Method of Payment

The quantity of the load tests to be paid for will be the number tests completed and accepted except that load tests made to calibrate different types of hammers, if not included in the Bill of Quantities, will not be measured for payments. Any incidentals

not otherwise described hereto are considered subsidiary to the work item and shall not be paid for separately.

Anchor and test piling, which are not part of the completed structure, will be included in the unit bid price for each "Load Test". Anchor and test piling or anchor and test shafts, which are a part of the permanent structure, will be paid for under the appropriate Item.

400(27a.5) Basis of Payment

The accepted quantity as provided in Section 400(27)a.4 shall be paid at the contract unit price in the Bill of Quantities. The price and payment shall constitute full compensation of the cost of Integrity Pile Testing, including tools, apparatus, testing and reporting and all labor and incidentals necessary to complete the work prescribed in this Item.

Payment will be made under:

Pay Item Number	Description	Unit of Measurement
400 (27)a	Load Test (Low Strain Dynamic Method, PIT)	Each

ITEM 400(28) PILE DYNAMIC TESTING

400(28).1 Description

High-Strain Dynamic Testing is performed by obtaining and analyzing record of shaft force and velocity under weights impact for evaluation of shaft load carrying capacity, structural integrity, and load-movement and shaft-soil load transfer relationships

Testing of drilled and cast-in-place shafts closely resembles testing of driven piles during re-strike. The following are specifications and instructions for high-strain dynamic testing of drilled and cast-in-place foundation shafts.

The work shall consist of furnishing all materials, equipment, and labor necessary for conducting high-strain dynamic tests on drilled and cast-in-placed shafts (hereinafter noted as test shaft). The Contractor shall not conduct the test himself but shall appoint an Independent Specialist to conduct all testing. The Contractor will be required to supply materials, equipment and labor, hereinafter as specified including prior to, during, and after the load test. High-strain Dynamic Testing is a non-destructive quick test and it is intended that the test shaft be left in a condition suitable for use in production. Testing procedures shall conform to the ASTM D4945-89 specification unless as otherwise noted below. The shaft used for the test will be instrumented and tested by the Independent Specialist, as approved by the Engineer, meeting requirements outlined in the ASTM D4945-89 specification as well as those outlined below.

400(28).2 Equipment and Material Requirements

The Contractor shall supply all labor, materials and equipment required to prepare the test shaft, dynamically load the shaft, and return the shaft to a condition suitable for use in the finished structure. Equipment to be supplied by the Contractor required to perform the test includes but is not limited to:

- 1) If a permanent casing is not used to construct the shaft, then a shaft top extension consisting of a thin walled casing or equivalent shall be used to extend the shaft by length at least equal to two and a half (2 ½) pile diameters such that the extended pile head is readily accessible by the testing engineer at the time of the test. If the shaft top is below grade, then the Contractor must have equipment available to remove surrounding soil (creating a safe working environment) so as to expose the concrete.
- 2) Means to ensure flat, level (axial to shaft) and sound concrete shaft top. Concrete should be on level with, or above the casing. Prior to the test, four "windows" approximately sized 6 by 6 inches (150 by 150mm) shall be provided at each quadrant of the casing
- 3) A drop weight in the range of one and half to two percent (1.5% to 2%) of the anticipated pile capacity, or as determined by the Engineer.
- 4) A guide allowing variable drop heights typically between 2 to 3m, or as determined by the Engineer.
- 5) A shaft top cushion consisting of new sheets of plywood with total thickness between 2 to 6 inches (50 to 150 mm), or as determined by the Engineer.
- 6) A steel striker plate with a thickness of at least 2 inches (50 mm) and an area between 70 to 90% of shaft top area but not less than the area of the impacting surface of the drop weight shall be placed on top of the plywood cushion.
- 7) If protruding reinforcing bars are present, the Contractor has the option to incorporate the reinforcing steel in the test area. Upon successful completion of the dynamic test, the surrounding concrete can then be removed as to make the pile suitable for use in the structure. If the Contractor selects not to incorporate the steel in such a manner as described above, 20% of the shaft cross sectional area shall be supplied with sufficient length, such that the ram impact will not interface with the reinforcing bars. Steel striker plates and plywood cushion must also be sized so that they cover as much as the impact area as possible.
- 8) One (1) k of 200 Volt AC Power.
- 9) Surveyor's transit, laser light or equivalent for measurement of pile set under each impact.

400(28).3 Dynamic Testing Firm

Testing is to be performed by an accredited Independent Specialist from a firm with a minimum of four (4) year experience in dynamic load testing. The actual test shall be conducted and/or supervised by a practicing Geotechnical Engineer with at least five (5) years of dynamic testing experience or who has achieved basic or better level experience on the foundation QA examination as Provider of PDA Testing services. The firm selected by the Contractor must be approved by the Engineer.

The Independent Specialist must supply the following testing instrumentation in addition to instrumentation outlined in ASTM specification D4945-89 Section 5:

- a) Pile Driving Analyzer (PDA)
- b) Calibrated Strain Transducers
- c) Calibrated Accelerometer

400(28).4 Reporting Results

The Independent Specialist appointed by the Contractor shall submit a timely report of the testing results to the Engineer for approval. The field results from at least one (CAPWAP) analysis (case Pile Wave Analysis Program) shall be submitted. The CAPWAP analysis shall be performed by an engineer that has achieved an advanced or better level on the foundation QA examination as providers of PDA Testing Services. The report must also provide the following:

- a) Wave Equation analysis results obtained prior to testing
- b) CAPWAP analysis result.
- c) For each impact the maximum measured force, maximum calculated tension force, transferred energy to the gage location, corresponding stresses, and the Case Method bearing capacity.
- d) Assessment of the test result with respect to both pile capacity and integrity.

400(28).5 Method of Payment

The quantity of the load tests to be paid for shall be the number of bored piles tested and accepted. Any item indicated and not otherwise described hereto shall be considered subsidiary to the work item and shall not be paid for separately.

400(28).6 Basis of Payment

The accepted quality as provided in Section 400(28).5 shall be paid at the contract unit price shown below. The payment shall constitute full compensation for the cost of Pile Dynamic Testing, the cost of appointing an Independent Specialist, all instrumentation, testing and testing equipment, analysis and reporting, tools, labor and all other incidentals necessary to complete the work prescribed in this Item.

Payment will be made under:

Pay Item Number	Description	Unit of Measurement
400(28)	Load Test (Pile Dynamic Method, PDA)	Each

ITEM 401 RAILINGS

401.1 Description

This Item shall consist of furnishing or fabricating and/or placing railings, for bridges and other structures of the material or combination of materials shown on the plans, constructed in reasonably close conformity with this Specification and to the lines, grades and dimensions shown in the Plans. Railing shall be classified as

concrete, steel, aluminum or timber in accordance with the predominating material contained in each.

401.2 Material Requirements**401.2.1 Concrete**

It shall conform to the applicable requirements prescribed in Item 405, Structural Concrete.

401.2.2 Reinforcing Steel

It shall conform to the requirements of Item 404, Reinforcing Steel and Wire Rope.

401.2.3 Steel

Structural steel consisting of steel and iron plates, shapes, pipes, fittings and castings shall conform to the requirements of Item 403, Metal Structures.

401.2.4 Aluminum

It shall conform to the requirements of AASHTO M 193, ASTM B 221 or ASTM B 308 or as called for on the Plans.

401.2.5 Paint

It shall conform to the requirements of Item 411, Paints.

401.3 Construction Requirement**401.3.1 General**

Railings shall be constructed to the lines and grades shown on the plans and shall not reflect any unevenness in the structure. All railing post shall be set plumb in hand or mechanically dug holes, unless driving is permitted. In the latter case, the manner of driving shall be in such as to avoid battering or distorting of post. Postholes shall be backfilled with acceptable material placed in layers and thoroughly compacted. When it is necessary to cut post holes in existing pavement, all loose materials shall be removed and the paving replaced in kind. Bridge railings shall not be constructed on a span until centering or falsework has been removed, rendering the span self-supporting.

Rail elements shall be erected according to plans and in a manner resulting in smooth, continuous installation with laps in the direction of traffic flow. All bolts except adjustment bolts shall be drawn tight. Bolts shall be sufficient length to extend beyond the nuts by more than 25mm.

Where painting of the railing component is specified, any damaged to the shop coat of paint shall be corrected by an application of an approved rust-inhibitive primer prior to painting. Ungalvanized surfaces inaccessible to painting after erection shall be field painted before erection. The railing components shall be given specified number of coats of paint uniformly applied by thorough brushing or by approved pressure spray.

Galvanized surfaces which have been abraded so that the base metal is exposed, threaded portions of all fittings and fasteners and cut ends of bolts shall be painted with two (2) coats of zinc-dust and zinc oxide paint.

401.3.2 Concrete Railing

1. Railing Cast-In-Place

The portion of the railing or parapet which is to be cast-in-place shall be constructed in accordance with the requirements of Item 405, Structural Concrete. Special care shall be exercised to secure smooth and tight fitting forms which can be rigidly held in line and grade and removed without injury to the concrete. Forms shall either be of single width boards or shall be lined with suitable material to have a smooth surface, which shall meet the approval of the Engineer or as shown on the Plans.

All moldings, panel work and bevel strips shall be constructed according to the detailed Plans with metered joints, and all corners in the finished work shall be true, sharp and clean-cut and shall be free from cracks, spalls and other defects.

2. Precast Railings

Moist tamped mortar precast members shall be removed from the molds as soon as practicable and shall be kept damp for a period of least ten (10) days. Any member that shows checking of soft corners of surfaces shall be rejected.

Expansion joint shall be constructed as to permit freedom of movement. After all work is completed, all loose or thin shells of mortar likely to spall under movement shall be carefully removed from all expansion joints by means of sharp chisel.

401.3 Method of Measurement

The quantity to be paid for shall be the number linear meters of specified railing actually completed and accepted measured from center to center of end posts.

401.4 Basis of Payment:

The accepted quantity measured as prescribed in Section 401.4, shall be paid for at the contract unit price for Railing, which price and payment shall be full compensation for furnishing and placing all materials including all labor, equipment, tools and incidentals necessary to complete this Item.

Payments will be made under:

Pay Item Number	Description	Unit of Measurement
401(2) a	Reinforced Concrete Railing (Standard)	Linear Meter
401(2) b	Reinforced Concrete Railing (Baluster), Painted	Linear Meter

ITEM 404 REINFORCING STEEL**404.1 Description**

This item shall consist of furnishing, bending, fabricating and placing of steel reinforcement of the type, size, shape and grade required in accordance with the Specification and in conformity with the requirements shown on the Plans or as directed by the Engineer.

404.2 Material Requirements

Reinforcing steel shall meet the requirements of Item 710, Reinforcing Steel and Wire Rope.

404.3 Construction Requirements

Should the Contractor propose to use reinforcing bar complying with JIS Standards, the Contractor shall, before materials are ordered, furnish the Engineer for approval Drawings annotated in English of the reinforcement arrangement of each affected structure, showing clearly any revised spacing or diameters of bars required to ensure that the design strength of the structure is maintained. The design strength shall be defined as the product of yield strength of reinforcing bar and the area of reinforcing bar provided in the section. Any expense incidental to the revisions of materials furnished in accordance with such Drawings shall be borne by the Contractor.

404.3.1 Order Lists

Before materials are ordered, the Contractor shall furnish all order lists and bending diagrams to the Engineer for approval. The approval of the order lists and bending diagrams by the Engineer shall in no way relieve the Contractor off responsibility for the correctness of such lists and diagrams.

Any expense incident to the revisions of materials furnished in accordance with such lists and diagrams to make them comply with the Plans shall be borne by the Contractor.

404.3.2 Rebar Fabrication and Installation

Fabrication and installation of rebar shall be done by a competent steel man to ensure good workmanship. There shall be proper supervision by the Contractor for the "cutting and bending" of reinforcing bars and frequent checking of bar schedule and clearances, from the beginning until the rebars are installed.

404.3.3 Protection of Materials

Steel reinforcement shall be stored above the surface of the ground upon platforms, skids, or other supports and shall be protected as far as practicable from mechanical injury and surface deterioration caused by exposure to conditions producing rust. When placed in the work, reinforcement shall be free from dirt, detrimental rust, loose scale, paint, grease, oil, or other foreign materials. Reinforcement shall be free from

injurious defects such as cracks and laminations. Rust, surface seams, surface irregularities or mill scale will not be cause for rejection, provided the minimum dimensions, cross sectional area and tensile properties of a hand wire brushed specimen meets the physical requirements for the size and grade of steel specified

404.3.4 Bar Bending, Splicing, Placing and Fastening

The Contractor shall submit to the Engineer for approval, the shop drawings indicating the bending, cutting, splicing and installation of all reinforcing bars.

All reinforcing bars requiring bending shall be cold-bent to the shapes shown on the Plans or required by the Engineer. Bars shall be bent around a circular pin having the following diameters (D) in relation to the diameter of the bar (d):

Nominal diameter, d,mm	Pin diameter (D)
10 to 20	6d
25 to 28	8d
32 and greater	10d

All steel reinforcement shall be accurately placed in the position shown on the Plans or required by the Engineer and firmly held there during the placing and setting of the concrete. Bars shall be tied at all intersections except where spacing is less than 300mm in each directions, in which case, alternate intersections shall be tied. Ties shall be fastened on the inside.

Distance from the forms shall be maintained by means of stays, blocks, ties, hangers, or other approved supports, so that it does not vary from the position indicated on the Plans by more than 6mm. Blocks for holding reinforcement from contact with the forms shall be precast mortar blocks of approved shapes and dimensions. Layers of bars shall be separated by precast mortar blocks or by other equally suitable devices. The use of pebbles, pieces of broken stone or brick, metal pipe and wooden blocks shall not be permitted. Unless otherwise shown on the Plans or required by the Engineer, the minimum distance between bars shall be 40mm. Reinforcement in any member shall be placed and then inspected and approved by the Engineer before the placing of concrete begins. Concrete placed in violation of this provision may be rejected and removal may be required. If fabric reinforcement is shipped in rolls, it shall be straightened before being placed. Bundled bars shall be tied together at not more than 1.8m intervals.

All reinforcement shall be furnished in the full lengths indicated on the Plans. Splicing of bars, except where shown on the Plans, will not be permitted without the written approval of the Engineer. Splices shall be staggered as far as possible and with a minimum separation of not less than 40 bar diameters. Not more than one-third of the bars may be spliced in the same cross-section, except where shown on the Plans. Unless otherwise shown on the Plans, bars shall be lapped a minimum distance of:

Splice Type	Grade 40	Grade 60	But not less than
Tension	24 bar dia	36 bar dia	300 mm
Compression	20 bar dia	24 bar dia	300 mm

In lapped splices, the bars shall be placed in contact and wired together. Lapped splices will not be permitted at locations where the concrete section is insufficient to provide minimum clear distance of one and one-third the maximum size of coarse aggregate between the splice and the nearest adjacent bar. Welding of reinforcing steel shall be done only if detailed on the Plans or if authorized by the Engineer in writing. Spiral reinforcement shall be spliced by lapping at least one and a half turns or by butt welding unless otherwise shown on the Plans.

404.4 Method of Measurement

The quantity of reinforcing steel to be paid for will be the final quantity placed and accepted in a completed structure.

No allowance will be made for tie-wires, separators, wire chairs and other material used in fastening the reinforcing steel in place. If bars are substituted upon the Contractor's request and approved by the Engineer and as result thereof more steel is used than specified, only the mass specified shall be measured for payment.

No measurement or payment will be made for splices added by the Contractor unless directed or approved by the Engineer.

Quantities to be paid for shall be the calculated theoretical number of kilograms of reinforcing steel bars, mesh or mats as determined from the net length of the steel as shown on the drawings, incorporated in concrete and accepted.

Reinforcing steel bars shall not be measured and paid separately where structures are paid in unit, as they are deemed included in the unit pay items of the structures.

The weight of plain or deformed bars or bar-mat information to AASHTO Specifications will be computed from the theoretical weight of plain round bars of the same nominal size as shown on the following table:

Bar Designation	Size (mm)	Unit Weight (kg/m)
#2	6	0.222
#3	10	0.616
#4	12	0.888
#5	16	1.579
#6	20	2.466
#8	25	3.854
#9	28	4.833
#10	32	6.313
#11	36	7.991

The weight of reinforcing steel conforming to JIS Standards will be computed from an equivalent table appropriate to JIS Standards and approved by the Engineer.

404.5 Basis of Payment

The accepted quantity, measured as prescribed in Section 404.4, shall be paid for at the contract price for Reinforcing Steel which price and payment shall be full compensation for furnishing and placing all materials, including all labor, equipment, tools and incidentals necessary to complete the work prescribed in this Item.

Payments will be made under:

Pay Item Number	Description	Unit of Measurement
404(1)a	Reinforcing Steel Bar, (Grade 40)	Kilogram
404(1)b	Reinforcing Steel Bar, (Grade 60)	Kilogram

ITEM 405 STRUCTURAL CONCRETE

405.1 Description

405.1.1 Scope

This Item shall consist of furnishing, bending, placing and finishing concrete in all structures except pavements in accordance with this Specification and conforming to the lines, grades, and dimensions shown on the Plans. Concrete shall consist of a mixture of Portland Cement, fine aggregate, coarse aggregate, admixture when specified, and water mixed in the proportions specified or approved by the Engineer.

405.1.2 Classes and Uses of Concrete

Five classes of concrete are provided for in this Item, namely: A, B, C, P and Seal. Each class shall be used in that part of the structure as called for on the Plans.

The classes of concrete will generally be used as follows:

Class A – All superstructures and heavily reinforced substructures. The important parts of the structure included are slabs, beams, girders, columns, arch ribs, box culverts, reinforced abutments, retaining walls, and reinforced footings.

Class B – Footings, pedestals, massive pier shafts, pipe bedding, and gravity walls, unreinforced or with only a small amount of reinforcement.

Class C – Thin reinforced sections, railings, precast R.C. piles and cribbing and for filler in steel grid floors.

Class P – Prestressed concrete structures and members.

Seal – Concrete deposited in water.

405.2 Material Requirements

405.2.1 Portland Cement

It shall conform to all the requirements of Subsection 311.2.1.

405.2.2 Fine Aggregate

It shall conform to all the requirements of Subsection 311.2.2.

405.2.3 Coarse Aggregate

It shall conform all the requirements of Subsection 311.2.3 except that gradation shall conform to Table 405.1.

Table 405.1 – Grading Requirements for Coarse Aggregate

Standard Mm	Alternate US Standard	Class A	Class B	Class C	Class P	Class Seal
63	2-1/2"					
50	2"	100	100			
37.5	1-1/2"	95 – 100	-			100
25	1"	-	35 – 70		100	95-100
19.0	3/4"	35 – 70	-	100	-	-
12.5	1/2"	-	10 – 30	90 – 100	-	25-60
9.5	3/8"	10 – 30	-	40 – 70	20 – 55	-
4.75	No.4	0 - 5	0 - 5	0 – 15*	0 – 10*	0-10

*The measured cement content shall be within plus (+) or minus (-) 2 mass percent of the design cement content.

405.2.4 Water

It shall conform to the requirements of Subsection 311.2.4

405.2.5 Reinforcing Steel

It shall conform to the requirements of Item 710, Reinforcing Steel and Wire Rope.

405.2.6 Admixtures

Admixtures shall conform to the requirements of Subsection 311.2.7

405.2.7 Curing Materials

Curing materials shall conform to the requirements of Subsection 311.2.8.

405.2.8 Expansion Joint

Expansion joint materials shall be:

1. Preformed Sponge Rubber and Cork, conforming to AASHTO M 153.
2. Hot-Poured Elastic Type, conforming to AASHTO M 173.
3. Preformed Fillers, conforming to AASHTO M 213.

405.2.9 Elastomeric Compression Joint Seals

These shall conform to AASHTO M 220.

405.2.10 Elastomeric Bearing Pads

These shall conform to AASHTO M 251 or Item 412 – Elastomeric Bearing Pads.

405.2.11 Storage of Cement and Aggregates

Storage of cement and aggregates shall conform to all the requirements of Subsection 311.2.10.

405.3 Sampling and Testing of Structural Concrete

As work progresses, at least one (1) sample consisting of three (3) concrete cylinder test specimens, 150 x 300mm (6 x 12 inches), shall be taken from each seventy five (75) cubic meters of each class of concrete or fraction thereof placed each day.

Compliance with the requirements of this Section shall be determined in accordance with the following standard methods of AASHTO:

Sampling of fresh concrete	T 141
Weight per cubic meter and air content (gravi- Metric) of concrete	T 121
Sieve analysis of fine and coarse aggregates	T 27
Slump of Portland Cement Concrete	T 119
Specific gravity and absorption of fine aggregate	T 84

Tests for strength shall be made in accordance with the following:

Making and curing concrete compressive and flexural tests specimens in the field	T 23
Compressive strength of molded concrete Cylinders	T 22

405.4 Production Requirements

405.4.1 Proportioning and Strength of Structural Concrete

The concrete materials shall be proportioned in accordance with the requirements for each class of concrete as specified in Table 405.2, using the absolute volume method as outlined in the American Concrete Institute (ACI) Standard 211.1. "Recommended Practice for Selecting

Proportions for Normal and Heavyweight Concrete". Other methods of proportioning may be employed in the mix design with prior approval of the Engineer. The mix shall either be designed or approved by the Engineer. A change in the source of materials during the progress of work may necessitate a new mix design.

The strength requirements for each class of concrete shall be as specified in Table 405.2.

Table 405.2 Composition and Strength of Concrete for Use in Structures

Class Of Concrete	Minimum Cement Content Per m ³ kg (bag**)	Maximum Water/Cement Ratio kg/kg	Consistency Range in Slump mm (inch)	Designated Size of Coarse Aggregate Square Opening Std. mm	Minimum Compressive Strength of 150x300mm Concrete Cylinder Specimen at 28 days, MN/m ² (psi)
A	364 (9.1 bags)	0.53	50 – 100 (2 – 4)	37.5 – 4.75 (1-1/2" – No. 4)	20.7 (3000)
B	320 (8 bags)	0.58	50 – 100 (2 – 4)	50 – 4.75 (2" – No. 4)	16.5 (2400)
C	380 (9.5 bags)	0.55	50 – 100 (2 – 4)	12.5 – 4.75 (1/2" – No. 4)	20.7 (3000)
P	440 (11 bags)	0.49	100 max. (4 max.)	19.0 – 4.75 (3/4" – No. 4)	37.7 (5000)
Seal	380 (9.5 bags)	0.58	100 – 200 (4 – 8)	25 – 4.75 (1" – No. 4)	20.7 (3000)

*The measured cement content shall be within plus or minus 2 mass percent of the design cement content.

**Based on 40 kg/bag

405.4.2 Consistency

Concrete shall have a consistency such that it will be workable in the required position. It shall be of such a consistency that it will flow around reinforcing steel but individual particles of the coarse aggregate when isolated shall show a coating of mortar containing its proportionate amount of sand. The consistency of concrete shall be gauged by the ability of the equipment to properly place it and not by the difficulty in mixing and transporting. The quantity of mixing water shall be determined by the Engineer and shall not be varied without his consent. Concrete as dry as it is practical to place with the equipment specified shall be used.

405.4.3 Batching

Measuring and batching of materials shall be done at a batching plant.

1. Portland Cement

Either sacked or bulk cement may be used. No fraction of a sack of cement shall be used in a batch of concrete unless the cement is weighed. All bulk cement shall be weighed on an approved weighing device. The bulk cement weighing hopper shall be properly sealed and

vented to preclude dusting operation. The discharge chute shall not be suspended from the weighing hopper and shall be so arranged that cement will neither be lodged in it nor leak from it.

Accuracy of batching shall be within plus (+) or minus (-) 1 mass percent.

2. Water

Water may be measured either by volume or by weight. The accuracy of measuring the water shall be within a range of error of not more than 1 percent.

3. Aggregates

Stockpiling of aggregates shall be in accordance with Subsection 311.2.10. All aggregates whether produced or handled by hydraulic methods or washed, shall be stockpiled or binned for draining for at least 12 hours prior to batching. Rail shipment requiring more than 12 hours will be accepted as adequate binning only if the car bodies permit free drainage. If the aggregates contain high or non-uniform moisture content, storage or stockpile period in excess of 12 hours may be required by the Engineer.

Batching shall be conducted as to result in a 2 mass percent maximum tolerance for the required materials.

4. Bins and Scales

The batching plant shall include separate bins for bulk cement, fine aggregate and for each size of coarse aggregate, a weighing hopper, and scales capable of determining accurately the mass of each component of the batch.

Scales shall be accurate to one-half (0.5) percent throughout the range used.

5. Batching

When batches are hauled to the mixer, bulk cement shall be transported either in waterproof compartments or between the fine and coarse aggregate. When cement is placed in contact with moist aggregates, batches will be rejected unless mixed within 1-1/2 hours of such contact. Sacked cement may be transported on top of the aggregates.

Batches shall be delivered to the mixer separate and intact. Each batch shall be dumped cleanly into the mixer without loss, and, when more than one batch is carried on the truck, without spilling of material from one batch compartment into another.

6. Admixtures

The Contractor shall follow an approved procedure for adding the specified amount of admixture to each batch and will be responsible for its uniform operation during the progress of the work. He shall provide separate scales for the admixtures which are to be proportioned by weight, and accurate measures for those to be proportioned by volume.

Admixtures shall be measured into the mixer with an accuracy of plus or minus three (3) percent.

The use of Calcium Chloride as an admixture will not be permitted.

405.4.4 Mixing and Delivery

Concrete may be mixed at the site of construction, at a central point or by a combination of central point and truck mixing or by a combination of central point mixing and truck agitating. Mixing and delivery of concrete shall be in accordance with the appropriate requirements of AASHTO M 157 except as modified in the following paragraphs of this section, for truck mixing or a combination of central point and truck mixing or truck agitating. Delivery of concrete shall be regulated so that placing is at a continuous rate unless delayed by the placing operations. The intervals between delivery of batches shall not be so great as to allow the concrete in-place to harden partially, and in no case shall such an interval exceed 30 minutes.

In exceptional cases and when volumetric measurements are authorized, for small project requiring less than 75 cu.m. per day of pouring, the weight proportions shall be converted to equivalent volumetric proportions. In such cases, suitable allowance shall be made for variations in the moisture condition of the aggregates, including the bulking effect in the fine aggregate. Batching and mixing shall be in accordance with ASTM C 685, Section 6 through 9.

Concrete mixing, by chute is allowed provided that a weighing scales for determining the batch weight will be used.

For batch mixing at the site of construction or at a central point, a batch mixer of an approved type shall be used. Mixer having a rated capacity of less than a one-bag batch shall not be used. The volume of concrete mixed per batch shall not exceed the mixer's nominal capacity as shown on the manufacturer's standard rating plate on the mixer except that an overload up to 10 percent above the mixer's nominal capacity may be permitted, provided concrete test data for strength, segregation, and uniform consistency are satisfactory and provided no spillage of concrete takes place. The batch shall be so charge into the drum that a portion of the water shall enter in advance of the cement and aggregates. The flow of water shall be uniform and all water shall be in the drum by the end of the first 15 seconds of the mixing period. Mixing time shall be measured from the time all materials, except water, are in the drum. Mixing time shall not be less than 60 seconds for mixers having a capacity of 1.5m³ or less. For mixers having a capacity greater than 1.5m³, the mixing time shall not be less than 90 seconds. If timing starts, the instant the skip reaches its maximum raised position, 4 seconds shall be added to the specified mixing time. Mixing time ends when the discharge chute opens.

The mixer shall be operated at the drum speed as shown on the manufacturer's name plate on the mixer. Any concrete mixed less than the specified time shall be discarded and disposed off by the Contractor at his own expenses.

The timing device on stationary mixers shall be equipped with a bell or other suitable warning device adjusted to give a clearly audible signal each time the lock is released. In case of failure of the timing device, the Contractor will be permitted to continue operations while it is being repaired, provided he furnishes an approved timepiece equipped with minute and second hands. If the timing device is not placed in good working order within 24 hours, further use of the mixer will be prohibited until repairs are made.

Retempering concrete will not be permitted. Admixtures for increasing the workability, for retarding the set, or for accelerating the set or improving the pumping characteristics of the concrete will be permitted only when specifically provided for in the Contract, or authorized in writing by the Engineer.

1. Mixing Concrete: General

Concrete shall be thoroughly mixed in a mixer of an approved size and type that will insure a uniform distribution of the materials throughout the mass.

All concrete shall be mixed in mechanically operated mixers. Mixing plant and equipment for transporting and placing concrete shall be arranged with an ample auxiliary installation to provide a minimum supply of concrete in case of breakdown of machinery or in case the normal supply of concrete is disrupted. The auxiliary supply of concrete shall be sufficient to complete the casting of a section up to a construction joint that will meet the approval of the Engineer.

Equipment having components made of aluminum or magnesium alloys, which would have contact with plastic concrete during mixing, transporting or pumping of Portland Cement concrete, shall not be used.

Concrete mixers shall be equipped with adequate water storage and a device of accurately measuring and automatically controlling the amount of water used.

Materials shall be measured by weighing. The apparatus provided for weighing the aggregates and cement shall be suitably designed and constructed for this purpose. The accuracy of all weighing devices except that for water shall be such that successive quantities can be measured to within one percent of the desired amounts. The water measuring device shall be accurate to plus or minus 0.5 mass percent. All measuring devices shall be subject to the approval of the Engineer. Scales and measuring devices shall be tested at the expense of the Contractor as frequently as the Engineer may deem necessary to insure their accuracy.

Weighing equipment shall be insulated against vibration or movement of other operating equipment in the plant. When the entire plant is running, the scale reading at cut-off shall not vary from the weight designated by the Engineer more than one mass

percent for cement, 1-1/2 mass percent for any size of aggregate, or one (1) mass percent for the total aggregate in any batch.

2. Mixing Concrete at Site

Concrete mixers may be of the revolving drum or the revolving blade type and the mixing drum or blades shall be operated uniformly at the mixing speed recommended by the manufacturer. The pick-up and throw-over blades of mixers shall be restored or replaced when any part or section is worn 20mm or more below the original height of the manufacturer's design. Mixers and agitators which have an accumulation of hard concrete or mortar shall not be used.

When bulk cement is used and volume of the batch is 0.5m³ or more, the scale and weigh hopper for Portland Cement shall be separate and distinct from the aggregate hopper or hoppers. The discharge mechanism of the bulk cement weigh hopper shall be interlocked against opening before the full amount of cement is in the hopper. The discharging mechanism shall also be interlocked against opening when the amount of cement in the hopper is underweight by more than one (1) mass percent or overweight by more than 3 mass percent of the amount specified.

When the aggregate contains more water than the quantity necessary to produce a saturated surface dry condition, representative samples shall be taken and the moisture content determined for each kind of aggregate.

The batch shall be so charged into the mixer that some water will enter in advance of cement and aggregate. All water shall be in the drum by the end of the first quarter of the specified mixing time.

Cement shall be batched and charged into the mixer so that it will not result in loss of cement due to the effect of wind, or in accumulation of cement on surface of conveyors or hoppers, or in other conditions which reduce or vary the required quantity of cement in the concrete mixture.

The entire content of a batch mixer shall be removed from the drum before materials for a succeeding batch are placed therein. The materials composing a batch except water shall be deposited simultaneously into the mixer.

All concrete shall be mixed for a period of not less than 1-1/2 minutes after all materials, including water, are in the mixer. During the period of mixing, the mixer shall operate at the speed for which it has been designed.

Mixers shall be operated with an automatic timing device that can be locked by the Engineer. The time device and discharge mechanics shall be so interlocked that during normal operation no part of the batch will be charged until the specified mixing time has elapsed.

The first batch of concrete materials placed in the mixer shall contain a sufficient excess of cement, sand, and water to coat inside of the drum without reducing the required mortar content of the mix. When mixing is to cease for a period of one hour or more, the mixer shall be thoroughly cleaned.

3. Mixing Concrete at Central Plant

Mixing at central plant shall conform to the requirements for mixing at the site.

4. Mixing Concrete in Truck

Truck mixers, unless otherwise authorized by the Engineer, shall be of the revolving drum type, water-tight, and so constructed that the concrete can be mixed to insure a uniform distribution of materials throughout the mass. All solid materials for the concrete shall be accurately measured and charged into the drum at the proportioning plant. Except as subsequently provided, the truck mixer shall be equipped with a device by which the quantity of water added can be readily verified. The mixing water may be added directly to the batch, in which case a tank is not required. Truck mixers may be required to be provided with a means of which the mixing time can be readily verified by the Engineer.

The maximum size of batch in truck mixers shall not exceed the minimum rated capacity of the mixer as stated by the manufacturer and stamped in metal on the mixer. Truck mixing, shall, unless otherwise directed be continued for not less than 100 revolutions after all ingredients, including water, are in the drum. The mixing speed shall not be less than 4 rpm, nor more than 6 rpm.

Mixing shall begin within 30 minutes after the cement has been added either to the water or aggregate, but when cement is charged into a mixer drum containing water or surface wet aggregate and when the temperature is above 32°C, this limit shall be reduced to 15 minutes. The limitation in time between the introduction of the cement to the aggregate and the beginning of the mixing may be waived when, in the judgement of the Engineer, the aggregate is sufficiently free from moisture, so that there will be no harmful effects on the cement.

When a truck mixer is used for transportation, the mixing time specified in Subsection 405.4.4 (3) at a stationary mixer may be reduced to 30 seconds and the mixing completed in a truck mixer. The mixing time in the truck mixer shall be as specified for truck mixing.

5. Transporting Mixed Concrete

Mixed concrete may only be transported to the delivery point in truck agitators or truck mixers operating at the speed designated by the manufacturers of the equipment as agitating speed, or in non-agitating hauling equipment, provided the consistency and workability of the mixed concrete upon discharge at the delivery

point is suitable point for adequate placement and consolidation in place.

Truck agitators shall be loaded not to exceed the manufacturer guaranteed capacity. They shall maintain the mixed concrete in a thoroughly mixed and uniform mass during hauling.

No additional mixing water shall be incorporated into the concrete during hauling or after arrival at the delivery point.

The rate of discharge of mixed concrete from truck mixers or agitators shall be controlled by the speed of rotation of the drum in the discharge direction with the discharge gate fully open.

When a truck mixer or agitator is used for transporting concrete to the delivery point, discharge shall be completed within one hour, or before 250 revolutions of the drum or blades, whichever comes first, after the introduction of the cement to the aggregates. Under conditions contributing to quick stiffening of the concrete or when the temperature of the concrete is 30°C, or above, a time less than one hour will be required.

6. Delivery of Mixed Concrete

The Contractor shall have sufficient plant capacity and transportation apparatus to insure continuous delivery at the rate required. The rate of delivery of concrete during concreting operations shall be such as to provide for the proper handling, placing and finishing of the concrete. The rate shall be such that the interval between batches shall not exceed 20 minutes. The methods of delivering and handling the concrete shall be such as will facilitate placing of the minimum handling.

405.5 Method of Measurement

The quantity of structural concrete to be paid for will be the final quantity placed and accepted in the completed structure. No deduction will be made for the volume occupied by pipe less than 100mm in diameter or by reinforcing steel, anchors, conduits, weep holes or expansion joint materials.

405.6 Basis of Payment

The accepted quantities, measured as prescribed in Section 405.4 shall be paid for in the contract unit price for each of the Pay item listed below that is included in the Bill of Quantities.

Payment shall constitute full compensation for furnishing, placing and finishing concrete including all labor, equipment, tools and incidentals necessary to complete the work prescribed in the Item.

Payment will be made under:

Pay Item Number	Description	Unit of Measurement
405(1)b2	Structural Concrete Class "A", ($f_c' = 27.58 \text{ Mpa}$) 14 days	Cubic Meter
405(1)b3	Structural Concrete Class "A", ($f_c' = 27.58 \text{ Mpa}$) 28 days	Cubic Meter

ITEM 406 PRESTRESSED CONCRETE STRUCTURES

406.1 Description

This Item shall consist of prestressed concrete structures and the prestressed concrete portions of composite structures, constructed in reasonably close conformity with the lines, grades and dimensions shown on the Plans or established by the Engineer and in accordance with this Specification. It shall also include the furnishing and installing of any appurtenant items necessary for the particular prestressing system to be used, including but not limited to ducts, anchorage assemblies and grouts used for pressure grouting ducts.

406.2 Material Requirements

406.2.1 Concrete and Grout

The materials for concrete and grout shall conform to Item 405, Structural Concrete. The concrete shall be Class P as shown in Table 405.2, unless otherwise shown on the Plans or specified in the Special Provisions. The proportions of the grout will be as set out in Subsection 406.3.11, Bonding Steel.

406.2.2 Prestressing Reinforcing Steel

It shall conform to Item 710, Reinforcing Steel and Wire Rope.

406.2.3 Prestressing Steel

It shall conform to the requirements of Item 710, Reinforcing Steel and Wire Rope.

All prestressing steel shall be protected against physical damage and rust or other results of corrosion at all times from manufacture to grouting. Prestressing steel that has sustained physical damage at any time shall be rejected.

406.2.4 Packaging, Storing and Shipping

Prestressing steel shall be packed in containers or other shipping forms for the protection of the steel against physical damage and corrosion during shipping and storage. A corrosion inhibitor which prevents rust or other results of corrosion shall be placed in the package or form, or when permitted by the Engineer, may be applied directly to the steel. The corrosion inhibitor shall have no deleterious effect on the steel or concrete or bond

strength of concrete to steel. Packaging or forms damaged from any cause shall be immediately replaced or restored to original condition.

This shipping package or form shall be clearly marked with a statement that the package contains high-strength prestressing steel and the care to be used in handling, and the type, kind and amount of corrosion inhibitor used, including the date when placed, safety orders and instructions for use.

406.2.5 Elastomeric Bearing Pads

This shall conform to Item 412(1), Elastomeric Bearing Pads.

406.2.6 Water

It shall conform to the requirements of Subsection 311.2.4, Water.

406.2.7 Enclosures

Duct enclosures for pre-stressing steel shall be galvanized ferrous metal or of a type approved by the Engineer, mortar tight and accurately placed at the locations shown on the Plans or approved by the Engineer. Transition couplings connecting said ducts to anchoring devices need not be galvanized.

406.2.8 Sampling and Testing

All wire, strand, anchorage assemblies or bars to be shipped to the site shall be assigned a lot number and tagged for identification purposes.

All samples submitted shall be representative of the lot to be furnished and in the case of wire or strand, shall be taken from the same master roll.

All of the materials specified for testing shall be furnished free of cost and shall be delivered in time for tests to be made well in advance of anticipated time of use.

The Contractor shall furnish for testing the following samples selected from each lot, if ordered by the Engineer. The selection of samples will be made at the manufacturer's plant by the Engineer or his representative.

1. For pre-tensioning work-samples at least 2 m long shall be furnished of each size of wire or strand proposed.
2. For post-tensioning work-samples of the following lengths shall be furnished of each size of wire proposed.
 - a. For wire requiring heading, 2 m.
 - b. For strand to be furnished with fittings, 1.50 m between near ends of fittings.
 - c. For bars to be furnished with thread ends and nuts, 1.5 m between threads at ends.
3. Anchorage assemblies – If anchorage assemblies are not attached to reinforcement samples, two (2) anchorage assemblies shall be

furnished, completed with distribution plates of each size and type to be used.

When prestressing system has been previously tested and approved for similar projects by an agency acceptable to the Engineer, complete tendon samples need not be furnished, provided there is no change whatsoever in the materials, design or details previously approved.

406.3 Construction Requirements

406.3.1 General

Prestressed concrete structural members shall be constructed in accordance with the requirements of Item 405, Structural Concrete and Reinforcing Steel shall be placed in accordance with the requirements of Item 404, Reinforcing Steel, subject to the modifications and amendments contained herein.

406.3.2 Prestressing Method

The method of prestressing to be used shall be optional with the Contractor subject to all requirements hereinafter specified.

The Contractor, prior to casting any members to be prestressed, shall submit to the Engineer for approval complete details of the methods, materials and equipment he proposes to use in the prestressing operations. Such details shall outline the method and sequence of stressing, complete specifications and details of the prestressing, steel and anchoring devices proposed for use, anchoring stresses, type of enclosures and all other data pertaining to the prestressing operations, including the proposed arrangement of the prestressing units in the members, pressure grouting materials and equipment.

406.3.3 Prestressing Equipment

Hydraulic jacks used to stress tendons shall be equipped with either a pressure gauge or a load cell for determining the jacking stress. The pressure gauge, if used, shall have an accurate reading dial at least 154 mm (6 inches) in diameter and each jack and its gauge shall be calibrated as a unit with the cylinder extension in the approximate position that it will be at final jacking force, and shall be accompanied by a certified calibration chart. The load cell, if used, shall be calibrated and shall be provided with an indicator by means of which the prestressing force in the tendon may be determined. The range of the load cell shall be such that the lower ten (10) percent of the manufacturer's rated capacity will not be used in determining the jacking stress.

Safety measures shall be taken by the Contractor to prevent accidents due to possible breaking of the prestressing steel or the slipping of the grips during the prestressing process.

406.3.4 Casting Yard

The precasting of prestressed concrete structural members may be done at a location selected by the Contractor, subject to the approval of the Engineer.

406.3.5 Placing Enclosures

Enclosures for prestressed reinforcement shall be accurately placed at locations shown on the Plans or approved by the Engineer.

406.3.6 Placing Steel

Steel units shall be accurately placed at the position shown on the Plans and firmly held during the placing and setting of the concrete.

Ducts may be fabricated with either welded or interlocked seams. Galvanizing of the welded steel will not be required. Ducts shall have sufficient strength to maintain their correct alignment and shape during placing of concrete. Joints between sections of ducts shall be positive metallic connections which do not result in angle changes at the joints. Waterproof tape shall be used at the connections.

All ducts or anchorage assemblies shall be provided with pipes or other suitable connections for the injection of grout after prestressing.

Ducts for pre-stressing steel shall be securely fastened in place to prevent movement.

After installation in the forms, the end of ducts shall at all times be covered as necessary to prevent the entry of water or debris.

All ducts for continuous structures shall be vented over each intermediate support, and at additional locations as shown on the Plans. Vents shall be 12.7 mm (1/2 inch) minimum diameter standard pipe. Connections to ducts shall be made with metallic structural fasteners. The vents shall be mortar tight, taped as necessary, and shall provide means for injection of grout through the vents and for sealing the vents. Ends of vents shall be removed 25.4 mm (1 inch) below the roadway surface after grouting has been completed.

Distances from the forms shall be maintained by stays, blocks, ties, hangers or other approved supports. Blocks for holding units from contact with the forms shall be precast mortar blocks of approved shape and dimensions. Layers of units shall be separated by mortar blocks or other equally suitable devices. Wooden blocks shall not be left in the concrete.

When acceptable prestressing steel for post-tensioning is installed in ducts after completion of concrete curing, and if stressing and grouting are completed within ten (10) calendar days after the installation of the prestressing steel, rust which may form during said ten (10) days will not be caused for rejection of the steel. Prestressing steel, installed, tensioned and grouted in this manner, all within ten (10) calendar days, shall be subject to all the requirements in this Item pertaining to corrosion protection and rejection because of rust.

No welds or grounds for welding equipment shall be made on the forms or on the steel in the manner after the prestressing steel has been installed.

Wires, wire groups, parallel-lay cables and any other prestressing elements shall be straightened to insure proper positioning in the enclosures.

Suitable horizontal and vertical spacers shall be provided, if required, to hold the wires in place in true position in the enclosures.

406.3.7 Pretensioning

The prestressing elements shall be accurately held in position and stressed by jacks. A record shall be kept of the jacking force and the elongations produced thereby. Several units may be cast in one continuous line and stressed at one time. Sufficient space shall be left between ends of units to permit access for cutting after the concrete has attained the required strength. No bond stress shall be transferred to the concrete, nor end anchorages released until the concrete has attained a compressive strength, as shown by cylinder tests, of at least 28 MPa unless otherwise specified. The elements shall be cut or released in such an order that lateral eccentricity or prestress will be a minimum.

406.3.8 Placing Concrete

Concrete shall not be deposited in the forms until the Engineer has inspected the placing of the reinforcement, enclosures, anchorages and prestressing steel and given his approval thereof. The concrete shall be vibrated with care and in such a manner as to avoid displacement of reinforcement, conduits, or wires.

Prior to placing concrete, the Contractor shall demonstrate to the Engineer that all ducts are unobstructed.

406.3.9 Curing

Steam curing process may be used as an alternative to water curing. The casting bed for any unit cured with steam shall be completely enclosed by a suitable type of housing, tightly constructed so as to prevent the escape of steam and simultaneously exclude outside atmosphere. Two to four hours after placing concrete and after the concrete has undergone initial set, the first application of steam or radiant heat shall be made unless retarders are used, in which case the waiting period before application of the steam or radiant heat shall be increased to from four to six hours.

During the waiting period, the temperature within the curing chamber shall not be less than 10.0°C (50°F) and live steam or radiant heat may be used to maintain the curing chamber at the proper minimum temperature. The steam shall be at 100 percent relative humidity to prevent loss of moisture and to provide moisture for proper hydration of the cement. Application of the steam shall not be directly on the concrete. During application of the steam, or of radiant heat, the ambient air temperature shall increase at a rate not to exceed 4.41°C per hour until the curing temperature is reached. The maximum curing temperature within the enclosure shall not exceed 71.1°C. The maximum temperature shall be held until the concrete has reached the desired strength. Detensioning shall be accomplished immediately after the steam curing or the heat curing has been discontinued and additional curing is not required after detensioning.

1. Curing with Low Pressure Steam

Application of live steam shall not be directed on the concrete forms as to cause localized high temperatures.

2. Curing with Radiant Heat

Radiant heat may be applied by means of pipes circulating steam, hot oil or hot water, or by electric heating elements. Radiant heat curing shall be done under a suitable enclosure to contain the heat and moisture loss shall be minimized by covering all exposed concrete surfaces with plastic sheeting or by applying an approved liquid membrane curing compound to all exposed concrete surfaces. Top surface of concrete members to be used in composite construction shall be clear of residue of the membrane-curing compound so as not to reduce bond below design limits.

If the Contractor proposes to cure by any other special method, the method and its details shall be subject to the approval of the Engineer.

406.3.10 Post-tensioning

Tensioning of the prestressing reinforcement shall not be commenced until tests on concrete cylinders, manufactured of the same concrete and cured under the same conditions, indicate that the concrete of the particular member to be prestressed has attained compressive strength of at least 28 MPa unless otherwise specified.

After all concrete has attained the required strength, the prestressing reinforcement shall be stressed by means of jacks to the desired tension and the stress transferred to the end anchorage.

Cast-in-place concrete shall not be post-tensioned until at least ten (10) days after the last concrete has been placed in the member to be the post-tensioned and until the compressive strength of said placed concrete has reached the strength specified for the concrete at the time of stressing.

All side forms for girders shall be removed before post-tensioning. The falsework under the bottom slab supporting the superstructure shall not be released until a minimum of 48 hours have elapsed after grouting of the post-tension tendons nor until all other conditions of the Specifications have been met. The supporting falsework shall be constructed in such a manner that the super restructure will be free to lift off the falsework and shorten during post-tensioning. Formwork left inside box girders to support the roadway slab shall be detailed in such a manner so as to offer minimum resistance to girder shortening due to shrinkage and post-tensioning.

The tensioning process shall be so conducted that the tension being applied and the elongation of the prestressing elements may be measured at all times. The friction loss in the element, i.e., the difference between the tension of the jack and the minimum tension, shall be determined in accordance with Article 1.6.7 of AASHTO Standard Specifications for Highway Bridges.

Suitable shims or other approved devices shall be used to insure that the specified anchor set loss is attained.

Prestressing tendons in continuous post-tensioned members shall be tensioned by jacking at each end of the tendon. Such jacking of both ends

need not be done simultaneously.

A record shall be kept of gage pressure and elongation at all times and submitted to the Engineer for his approval.

406.3.11 Bonding Steel

Prestressing steel shall be bonded to the concrete by filling the void space between the duct and the tendon with grout

Grout shall consist of Portland Cement, water and an expansive admixture approved by the Engineer.

Water shall be potable.

No admixture containing chlorides or nitrates shall be used.

Water shall first be added to the mixer followed by cement and admixture.

The grout shall be mixed in mechanical mixing equipment of a type that will produce uniform and thoroughly mixed grout. The water content shall be not more than 19 litres (5 gallons) per sack of cement. Retempering of grout will not be permitted. Grout shall be continuously agitated until it is pumped.

Grouting equipment shall be capable of grouting at a pressure of at least 0.6894 MPa (100 psi).

Grouting equipment shall be furnished with a pressure gauge having a full-scale reading of not more than 2.07 MPa (300 psi).

Standby flushing equipment capable of developing a pumping pressure of 1.72 MPa (250 psi) and of sufficient capacity to flush out any partially grouted ducts shall be provided.

All ducts shall be clean and free of deleterious materials that would impair bonding of the grout or interfere with grouting procedures. All grout shall pass through a screen with a 2 mm (0.0787 inch) maximum clear openings prior to being introduced into the grout pump.

Grout injection pipes shall be fitted with positive mechanical shutoff valves. Vents and ejection pipes shall be fitted with valves, caps or other devices capable of withstanding the pumping pressures. Valves and caps shall not be removed or opened until the grout has set.

Post-tensioned steel shall be bonded to the concrete. All prestressing steel to be bonded to the concrete shall be free of dirt, loose rust, grease or other deleterious substances.

Immediately after completion of the concrete pour, the metal conduit shall be blown out with compressed oil free air to the extent necessary to break up and remove any mortar in the conduit before it hardens. Approximately 24 hours after the concrete pour, the metal conduits shall be flushed out with water and then blown out with compressed oil free air.

Prior to placing forms for roadway slabs of box girder structures, the Contractor shall demonstrate to the satisfaction of the Engineer that all ducts

are unobstructed and if the prestressing reinforcement has been placed, that the steel is free and unbonded in the duct.

After the tendons have been stressed to the required tension, each conduit encasing the prestressing steel shall be blown out with compressed oil free air. The conduit shall then be completely filled from the low end with grout under pressure. Grout shall be pumped through the duct and continuously wasted at the outlet until no visible slugs of water or air are ejected and the efflux time of ejected grout is not less than 11 seconds. All vents and openings shall then be closed and the grouting pressure at the injection end shall be raised to a minimum of 0.6894 MPa (100 psi) and held for a minimum of 10 seconds.

If aluminum powder is used to expand the grout, it shall be added as follows:

From 2 to 4 grams of the unpolished variety (about 1 to 2 teaspoons) shall be added for each sack of cement used in the grout. The exact amount of aluminum powder will be designated by the Engineer. The dosage per batch of grout shall be carefully weighed. A number of weighings may be made in the laboratory and doses placed in glass vials for convenient use in the mix. The aluminum powder shall be blended with pumicite or other inert powder in the proportion of one (1) part powder to fifty (50) parts pumicite (or other inert powder) by weight. The blend shall be thoroughly mixed with the cement. The amount of the blend used should vary from 120 g (4-1/2 ounces) per sack of cement for concrete having a temperature of 21.1°C to 190 g (7 ounces) for a temperature of 4.44°C after all ingredients are added, the batch shall be mixed for 3 minutes. Batches of grout shall be placed within 45 minutes after mixing.

406.3.12 Unbonded Steel

Where the steel is not to be bonded to the concrete, it shall be carefully protected against corrosion by a coating of tar or other waterproofing material, in addition to any galvanizing, which may be specified in addition to the requirements of ASTM A 416 (AASHTO M 203) and ASTM A 421 (AASHTO M 204.)

406.3.13 Handling

Extreme care shall be exercised in handling and moving precast prestressed concrete mortar members. Precast girders and slabs shall be transported in an upright position and the points of support and directions of the reactions with respect to the member shall be approximately the same during transportation and storage as when the members are in their final position. If the Contractor deems it expedient to transport or store precast units in other than this position, it shall be done at his own risk after notifying the Engineer of his intention to do so.

Prestressed concrete girders shall not be shipped until tests on concrete cylinders, manufactured of the same concrete and cured under the same conditions as the girders, indicate that the concrete of the particular girder has attained a compressive strength equal to the specified design

compressive strength of the concrete in the girder and has attained a minimum age of 14 days.

406.3.14 Composite Slab Construction

The manufacturing tolerances for pre-cast members shall not exceed those given for length, cross-section and straightness on the Plans, as specified in the Contract or as approved by the Engineer. In addition, where beams are laid side by side in a deck:

1. The difference on soffit level between adjacent units before the in-situ concrete is placed shall not exceed 5 mm for units up to 10 mm for longer units.
2. The width of the deck soffit shall be within ± 25 mm.
3. In adjacent span, the continuity of the outside beams shall be maintained.
4. The width of gap between individual beams shall not exceed twice the nominal gap.
5. The alignment of transverse holes shall permit the reinforcement or prestressing cables to be placed without distortion.

406.4 Method of Measurement

406.4.1 Structural Members

The quantity to be measured for payment will be the actual number of precast pre-stressed concrete structural members, except piling, of the several types and sizes, installed in place, completed and accepted. Each member will include the concrete, reinforcement and pre-stressing steel, anchorages, plates, nuts, elastomeric bearing pads, and other such material contained within or attached to the unit.

Piling will be measured as provided in Item 400.

406.4.2 Other Items

The quantities of other Contract items which enter into the completed and accepted structure will be measured for payment in the manner prescribed for the several items involved.

406.5 Basis of Payment

The accepted quantities, measured as prescribed in Section 406.4 shall be paid for at the contract unit price for each of the particular item listed below that is included in the Bill of Quantities, which price and payment shall be full compensation for furnishing and placing all materials, including all labor, equipment, tools and incidentals necessary to complete the work prescribed in this Item.

Payment will be made under:

Pay Item Number	Description	Unit of Measurement
406(1)g6	Prestressed Structural Concrete Members (AASHTO Girder Type VI, L= 31.30m)	Each
406(1)g7	Prestressed Structural Concrete Members (AASHTO Girder Type V, L= 32.00m)	Each
406(1)g8	Prestressed Structural Concrete Members (AASHTO Girder Type V, L= 32.75m)	Each
406(1)h2	Prestressed Structural Concrete Members (AASHTO Girder Type VI, L= 34.20m)	Each
406(1)h3	Prestressed Structural Concrete Members (AASHTO Girder Type VI, L= 35.00m)	Each
406(1)h4	Prestressed Structural Concrete Members (AASHTO Girder Type VI, L= 35.80m)	Each

ITEM 407 CONCRETE STRUCTURES

407.1 Description

This item shall consist of general description of the materials, equipment, workmanship and construction requirements of concrete structures and concrete portions of composite structures conforming to the alignment , grades, design, dimensions and details shown on the Plans and in accordance with the Specifications for piles reinforcing steel, structural steel, structural concrete and other items which constitute the completed structure. The class of concrete to be used in the structure or part of the structure shall be as specified in Item 405, Structural Concrete.

407.2 Material Requirements

1. Concrete and Concrete Ingredients

Concrete and concrete materials shall conform to the requirements in Item 405, Structural Concrete. Unless otherwise shown on the Plans or specified in the Special Provisions, concrete shall be Class A.

2. Reinforcing Steel

Reinforcing steel shall conform to the requirements in Item 404, Reinforcing Steel.

3. Structural Steel

Structural steel shall conform to the requirements of corresponding materials in Item 403, Metal Structures.

4. Bridge Bearing (Elastomeric Bearing Pad)

Elastomeric bearing pads shall conform to Item 412, Elastomeric Bearing Pads.

5. Paints

Paints shall conform to the requirements in Item 411, Paint.

6. Waterproofing and Damp-proofing.

Unless otherwise shown on the Plans and indicated in Special Provisions, materials for waterproofing and damp-proofing shall conform to the requirements of the following specifications;

- a. AASHTO M 115 Asphalt for damp-proofing and waterproofing.
- b. AASHTO M 116 Primer for the use with Asphalt in damp-proofing and waterproofing.
- c. AASHTO M 117 Woven cotton fabrics saturated with bituminous substances for use in waterproofing.
- d. AASHTO M 118 Coal-Tar pitch for roofing, damp-proofing and waterproofing.
- e. AASHTO M 121 Creosote for priming coat with coal-tar pitch damp-proofing and waterproofing.
- f. AASHTO M 159 Woven burlap fabric saturated with bituminous substances for use in waterproofing.
- g. AASHTO M 166 Numbered cotton duck and array duck.
- h. AASHTO M 239 Asphalt for use in waterproofing membrane construction.

7. Concrete Curing Compound

Curing compound shall conform to the requirements of AASHTO M 148 Liquid membrane-forming compounds for curing concrete.

8. Joint Filler

Unless otherwise shown in the Plans or in Special Provisions, materials for expansion joint filler shall conform to the requirements of AASHTO M 33, AASHTO M 153, AASHTO M 173, ASHTO M 213 and ASHTO M 220.

407.2.1 Proportioning and Strength of Structural Concrete

This shall be in accordance with Item 405 Structural Concrete.

407.2.2 Sampling and Testing

This shall be in accordance with Item 405, Structural Concrete.

407.3 Construction and Requirements**407.3.1 Handling and Placing Concrete: General**

Concrete shall not be placed until forms and reinforcing steel have been checked and approved by the Engineer.

If lean concrete is required in the Plan or as directed by the Engineer prior to placing of reinforcing steel bar, the lean concrete should have a minimum compressive strength of 13.8 MPa (2,000 psi)..

In preparation for the placing of concrete, all sawdust, chips and other construction debris and extraneous matter shall be removed from inside the formwork, struts, stays and braces, serving temporarily to hold the forms in correct shape and alignment, pending the placing of concrete at their locations, shall be removed when the concrete placing has reached an elevation rendering their service unnecessary. These temporary members shall be entirely removed from the forms and not buried in the concrete.

No concrete shall be used which does not reach its final position in the forms within the time stipulated under "Time of Hauling and Placing Mixed Concrete".

Concrete shall be placed so as to avoid segregation of the materials and the displacement of the reinforcement. The use of long troughs, chutes, and pipes for conveying concrete to the forms shall be permitted only on written authorization of the Engineer. The Engineer shall reject the use of the equipment for concrete transportation that will allow segregation, loss of fine materials, or in any other way will have a deteriorating effect on the concrete quality.

Open troughs and chutes shall be of metal lined; where steep slopes are required, the chutes shall be equipped with baffles or be in short lengths that reverse the direction of movement to avoid segregation.

All chutes, troughs and pipes shall be kept clean and free from coatings of hardened concrete by thoroughly flushing with water after each run. Water used for flushing shall be discharged clear of the structure.

When placing operations would involve dropping the concrete more than 1.5 m, concrete shall be conveyed through sheet metal or approved pipes. As far as practicable, the pipes shall be kept full of concrete during placing and their lower end shall be kept buried in the newly placed concrete. After initial set of the concrete, the forms shall not be jarred and no strain shall be placed on the ends of projecting reinforcement bars.

The concrete shall be placed as nearly as possible to its final position and the use of vibrators for moving of the mass of fresh concrete shall not be permitted.

407.3.1.1 Placing Concrete by Pneumatic Means

Pneumatic placing of concrete will be permitted only if specified in the Special Provisions or authorized by the Engineer. The equipment shall be so arranged that vibration will not damage freshly placed concrete.

Where concrete is conveyed and placed by pneumatic means, the equipment shall be suitable in kind and adequate in capacity for the work. The machine shall be located as close as practicable to the work. The discharge lines shall

be horizontal or inclined upwards from the machine. The discharge end of the line shall not be more than 3 m from the point of deposit.

At the conclusion of placing the concrete, the entire equipment shall be thoroughly cleaned.

407.3.1.2 Placing of Concrete by Pumping

The placing of concrete by pumping will be permitted only if specified or if authorized by the Engineer. The equipment shall be so arranged that vibration will not damage freshly placed concrete.

Where concrete is conveyed and placed by mechanically applied pressure the equipment shall be suitable in kind and adequate in capacity for the work. The operation of the pump shall be such that a continuous stream of concrete without air pockets is produced. When pumping is completed, the concrete remaining in the pipeline, if it is to be used, shall be ejected in such a manner that there will be no contamination of the concrete or separation of the ingredients. After this operation, the entire equipments shall be thoroughly cleaned.

407.3.1.3 Placing Concrete in Water

Concrete shall not be placed in water except with approval of the Engineer and under his immediate supervision. In this case the method of placing shall be hereinafter specified.

Concrete deposited in water shall be Class A concrete with a minimum cement content of 400 kg/m³ of concrete. The slump of the concrete shall be maintained between 10 and 20 cm. To prevent segregation, concrete shall be carefully placed in a compact mass, in its final position, by means of a tremie, a bottom-dump bucket, or other approved means, and shall not be disturbed after being placed.

A tremie shall consist of a tube having a diameter of not less than 250 mm constructed in sections having flanged couplings fitted with gaskets with a hopper at the top. The tremie shall be supported so as to permit free movement of the discharge and over the entire top surface of the work and so as to permit rapid lowering when necessary to retard or stop the flow of concrete. The discharge end shall be closed at the start of work so as to prevent water entering the tube and shall be completely submerged in concrete at all times; the tremie tube shall be kept full to the bottom of the hopper. When a batch is dumped into the hopper, the flow of concrete shall be induced by lightly raising the discharge end, but always keeping it in the placed concrete. The flow shall be continuous until the work is completed.

When the concrete is placed with a bottom-dump bucket, the top of the bucket shall be open. The bottom doors shall open freely downward and outward when tripped. The buckets shall be completely filled and slowly lowered to avoid backwash. It shall not be dumped until it rests on the surface upon which the concrete is to be deposited and when discharged shall be withdrawn slowly until well above the concrete.

407.3.2 Compaction of Concrete

Concrete during and immediately after placing shall be thoroughly compacted. The concrete in walls, beams, columns and the like shall be placed in horizontal layers not more than 30 cm thick except as hereinafter provided. When less than a complete layer is placed in one operation, it shall be terminated in a vertical bulkhead. Each layer shall be placed and compacted before the preceding layer has taken initial set to prevent injury to the green concrete and avoid surfaces of separation between the layers. Each layer shall be compacted so as to avoid the formation of a construction joint with a preceding layer.

The compaction shall be done by mechanical vibration. The concrete shall be vibrated internally unless special authorization of other methods is given by the Engineer or is provided herein. Vibrators shall be of a type, design, and frequency approved by the Engineer. The intensity of vibration shall be such as to visibly affect a mass of concrete with a 3 cm slump over a radius of at least 50 cm. A sufficient number of vibrator shall be provided to properly compact each batch immediately after it is placed in the forms. Vibrators shall be manipulated so as to thoroughly work the concrete around the reinforcement and embedded fixtures and into the corners and angles of the forms and shall be applied at the point of placing and in the area of freshly placed concrete. The vibrators shall be inserted into and withdrawn from the concrete slowly. The vibration shall be of sufficient duration and intensity to compact the concrete thoroughly but shall not be continued so as to cause segregation and at any one point to the extent that localized areas of grout are formed. Application of vibrators shall be at points uniformly spaced, and not farther apart than twice the radius over which the vibration is visibly effective. Vibration shall not be applied directly or thru the reinforcement to sections or layers of concrete that have hardened to the degree that the concrete ceases to be plastic under vibration. It shall not be used to make concrete flow in the forms over distances so great as to cause segregation, and vibrators shall not be used to transport concrete in the forms of troughs or chutes.

407.3.3 Casting Sections and Construction Joints

The concrete in each form shall be placed continuously. Placing of concrete in any such form shall not be allowed to commence unless sufficiently inspected and approved materials for the concrete is at hand, and labor and equipment are sufficient to complete the pour without interruption.

Joints in the concrete due to stopping work shall be avoided as much as possible. Such joints, when necessary, shall be constructed to meet the approval of the Engineer.

When the placing of concrete is temporarily discontinued, the concrete, after becoming firm enough to retain its shape, shall be cleaned of laitance and other objectionable material to a sufficient depth to expose sound concrete. Where a "faster edge" might be produced at a construction joint, as in the sloped top surface of a wingwall, an inset formwork shall be used to produce an edge thickness of not less than 15 cm in the succeeding layer. Work shall not be discontinued within 50 cm of the top of any face, unless provision has been made for a coping less than 50 cm thick, in which case if permitted by the Engineer, the construction joint may be made at the underside of coping.

Immediately following the discontinuance of placing concrete, all accumulations of mortar splashed upon the reinforcing steel and the surfaces of forms shall be removed. Dried mortar chips and dust shall not be puddled into the unset concrete. Care shall be exercised, during the cleaning of the reinforcing steel, not to injure or break the concrete-steel bond at and near the surface of the concrete.

407.3.4 Casting Box Culverts

In general, the base slab of box culverts shall be placed and allowed to set before the remainder of the culvert is constructed. In the construction of box culverts the side walls and top slab may be constructed as a monolith.

If the concrete in the walls and top slab is placed in two separate operations, special care shall be exercised in order to secure bonding in the construction joint and appropriate keys shall be left in the sidewalls for anchoring the top slab. Each wingwall shall be constructed, if possible, as a monolith. Construction joints where unavoidable, shall be horizontal and so located that no joints will be visible in the exposed face of the wingwall above the ground line.

Vertical construction joints shall be at right angles to the axis of the culverts.

407.3.5 Casting Columns, Slabs and Girders

Concrete in columns shall be placed in one continuous operation, unless otherwise directed. The concrete shall be allowed to set for at least 20 hours before the caps are placed.

Unless otherwise permitted by the Engineer, no concrete shall be placed in the superstructure until the column forms have been stripped sufficiently to determine the condition of the concrete in the column. The load of the superstructure shall not be allowed to come upon the bents until they have been in place at least 14 days, unless otherwise permitted by the Engineer.

Concrete in slab spans shall be placed in one continuous operation for each span unless otherwise provided.

Concrete in T-Beam or deck girder spans shall be placed in one continuous operation unless otherwise directed. If it is permitted to place the concrete in two separate operations, each of the operations, shall be continuous: first, to the top of the girder stems, and second, to completion. In the latter case, the bond between stem and slab shall be secured by means of suitable shear keys which may be formed by the use of timber blocks approximately 50 mm x 100 mm in cross-section having a length of 100 mm less than the width of the girder stem. These key blocks shall be placed along the girder stems as required, but the spacing shall not be greater than 300 mm center to center. The blocks shall be beveled and oiled in such a manner as to insure their ready removal, and they shall be removed as soon as the concrete has set sufficiently to retain its shape. If the contractor wishes to place the concrete in two separate operations, he shall, with his request for permission to do so, submit plans and proposals of the required changes to the reinforcement, which plans and proposals shall be subject to the approval of the Engineer. In box girders, the concrete in the bottom slab be poured first, as a separate operation.

The concrete in the webs and the top slab shall be placed in one continuous operation unless otherwise specified. If it is permitted to place the concrete in more than one operation, the requirements for T-beam shall apply.

407.3.6 Construction Joints

Construction joints shall be made only where shown on the Plans or called for in the pouring schedule, unless otherwise approved by the Engineer. Shear keys or reinforcement shall be used, unless otherwise specified, to transmit shear or to bond the two sections together.

Before depositing new concrete on or against concrete which has hardened, the forms shall be retightened. The surface of the hardened concrete shall be roughened as required by the Engineer, in a manner that will not leave loose particles of aggregate or damage concrete at the surface. It shall be thoroughly cleaned of foreign matter and laitance. When directed by the Engineer, the surface of the hardened concrete which will be in contact with new concrete shall be washed with water to this satisfaction, and to insure an excess of mortar at the juncture of the hardened and the newly deposited concrete, the cleaned and saturated surfaces, including vertical and inclined surfaces shall first be thoroughly covered with a coating of mortar of the same proportion of sand and cement as the class of concrete used against which the new concrete shall be placed before the grout or mortar has attained its initial set.

The placing of concrete shall be carried continuously from joint to joint. The face edges of all joints which are exposed to view shall be carefully finished true to line and elevation.

407.3.7 Concrete Surface Finishing

Surface finishing shall be classified as follows:

- Class 1, Ordinary Finish
- Class 2, Rubbed Finish
- Class 3, Floated Finish

All concrete shall be given Class 1, Ordinary Finish and additionally any further finish as specified.

Unless otherwise specified, the following surfaces shall be given a Class 2, Rubbed Finish.

1. The exposed faces of piers, abutments, wingwalls, and retaining walls.
2. The outside faces of girders, T-beams, slabs, columns, brackets, curbs, headwalls, railings, arch rings, spandrel walls and parapets.

Excluded, however, are the tops and bottoms of floor slabs and sidewalks, bottoms of beams and girders, sides of interior beams and girders, backwalls above bridge seats or the underside of copings. The surface finish on piers and abutments shall include all exposed surfaces below the bridge seats to 20 cm below low water elevation or 50 cm below finished ground level when such ground level is above the water surface. Wingwalls shall be finished from the top to 50 cm below the finished slope lines on the outside face and

shall be finished on top and for a depth of 20 cm below the top on the back sides.

Unless otherwise specified, the surface of the traveled way shall be Class 3, Floated Finish.

Class 1, Concrete Ordinary Finish

Immediately following the removal of forms, all fins and irregular protection shall be removed from all surface except from those which are not to be exposed or are not to be waterproofed. On all surfaces the cavities produced by form ties and all other holes, honeycomb spots, broken corners or edges and other defects shall be thoroughly cleaned, and after having been kept saturated with water for a period of not less than three hours shall be carefully pointed and made true with a mortar of cement and fine aggregate mixed in the proportions used in the grade of the concrete being finished. Mortar used in pointing shall not be more than one hour old. The mortar patches shall be cured as specified under Subsection 407.3.8. All construction and expansion joints in the completed work shall be left carefully tooled and free of all mortar and concrete. The joint filler shall be left exposed for its full length with a clean and true edges.

The resulting surface shall be true and uniform. All repaired surfaces, the appearance of which is not satisfactory to the Engineer, shall be "rubbed" as specified below.

Class 2, Concrete Rubbed Finish

After removal of forms, the rubbing of concrete shall be started as soon as its condition will permit. Immediately before starting this work, the concrete shall be kept thoroughly saturated with water for a minimum period of three hours. Sufficient time shall have elapsed before the wetting down to allow the mortar used in the pointing of road holes and defects to thoroughly set. Surfaces to be finished shall be rubbed with a minimum coarse carborundum stone using a small amount of mortar on each face. The mortar shall be composed of cement and fine sand mixed in the proportions used in the concrete being finished. Rubbing shall be continued until all form marks, protections and irregularities have been removed, all voids have been filled, and a uniform surface has been obtained. The face produced by this rubbing shall be left in place at this time.

After all concrete above the surface being created has been cast, the final finish shall be obtained by rubbing with a fine carborundum stone and water. This rubbing shall be continued until the entire surface is of smooth texture and uniform color.

After the final rubbing is completed and the surface has dried, it should be rubbed with burlap to remove loose powder and shall be left free from all unsound patches, paste, powder and objectionable marks.

Class 3, Concrete Floated Finish

After the concrete is compacted as specified in Subsection 407.3.2, Compaction of Concrete, the surface shall be carefully struck off with a strike board to conform to the cross-section and grade shown on the Plans. Proper allowance shall be made for camber if required. The strike board may be operated longitudinally or transversely and shall be moved forward with a combined longitudinal and transverse motion, the manipulation being such that neither is raised from the side forms during the process. A slight excess of concrete shall be kept in front of the cutting edge at all times.

After striking off and consolidating as specified above, the surface shall be made uniform by longitudinal or transverse floating or both. Longitudinal floating will be required except in places where this method is not feasible.

The longitudinal float, operated from foot bridges, shall be worked with a sawing motion while held in a floating position parallel to the road centerline and passing gradually from one side of the pavement to the other. The float shall then be moved forward one-half of each length and the above operation repeated. Machine floating which produces an equivalent result may be substituted for the above manual method.

The transverse float shall be operated across the pavement by starting at the edge and slowly moving to the center and back again to the edge. The float shall then be moved forward one-half of each length and the above operation repeated. Care shall be taken to preserve the crown and cross-section of the pavement.

After the longitudinal floating has been completed and the excess water removed, but while the concrete is still plastic, the slab surface shall be tested for trueness with a straight-edge. For the purpose, the Contractor shall furnish and use an accurate 3 m straight-edge swing handless 1 m longer than one half the width of the slab.

The straight-edge shall be held in successive positions parallel to the road centerline and in contact with the surface and the whole area gone over from one side of the slab to the other as necessary advancement along the deck shall be in successive stages of not more than one-half the length of the straight-edge. Any depression found shall be immediately filled with freshly mixed concrete, struck off, consolidated and refinished. The straight-edge testing and refloating shall continue until the entire surface is found to be free from observable departure from the straight-edge and the slabs has the required grade and contour, until there are no deviations of more than 3 mm under the 3 m straight-edge.

When the concrete has hardened sufficiently, the surface shall be given a broom finish. The broom shall be an approved type. The strokes shall be square across the slabs from edge to edge, with adjacent strokes slightly overlapped, and shall be made by drawing the broom without tearing the concrete, but so as to produce regular corrugations not over 3 mm in depth. The surface as thus finished shall be free from porous spots, irregularities, depressions and small pockets or rough spots such as may be caused by accidental

disturbing, during the final brooming of particles of coarse aggregate embedded near the surface.

Concrete Surface Finish for Sidewalk.

After the concrete has been deposited in place, it shall be compacted and the surface shall be struck off by means of strike board and floated with a wooden or cork float. An edging tool shall be used on all edges and at all expansion joints. The surface shall not vary more than 3 mm under a 3 m straight-edge. The surface shall have a granular or matted texture which will not slick when wet.

407.3.8 Curing Concrete

All newly placed concrete shall be cured in accordance with this Specification, unless otherwise directed by the Engineer. The curing method shall be one or more of the following:

1. Water Method

The concrete shall be kept continuously wet by the application of water for a minimum period of 7 days after the concrete has been placed.

The entire surface of the concrete shall be kept damp by applying water with an atomizing nozzle. Cotton mats, rugs, carpets, or earth or sand blankets may be used to retain the moisture. At the expiration of the curing period the concrete surface shall be cleared of the curing medium.

2. Curing Compound

Surfaces exposed to the air may be cured by the application of an impervious membrane if approved by the Engineer.

The membrane-forming compound used shall be practically colorless liquid. The use of any membrane-forming compound that will alter the natural color of the concrete or impart a slippery surface to any wearing surface shall be prohibited. The compound shall be applied with a pressure spray in such a manner as to cover the entire concrete surface with a uniform film and shall be of such character that it will harden within 30 minutes after application. The amount of compound applied shall be ample to seal the surface of the concrete thoroughly. Power-operated spraying equipment shall be equipped with an operational pressure gauge and means of controlling the pressure.

The curing compound shall be applied to the concrete following the surface finishing operation immediately after the moisture sheen begins to disappear from the surface, but before any drying shrinkage or craze cracks begin to appear. In the event of any delay, in the application of the curing compound, which results in any drying or cracking of the surface, application of water with an atomizing nozzle as specified under "Water Method", shall be started immediately and shall be continued until the application of the compound is resumed or started, however, the compound shall not be applied over any resulting free standing water. Should the film of compound be damaged from any cause before the expiration of 7 days after the concrete is placed in the case of structures, the damaged portion shall be repaired immediately with additional compound.

Curing compound shall not be diluted or altered in any manner after manufacture. At the time of use, the compound shall be in a thoroughly mixed condition. If the compound has not been used within 120 days after the date of manufacture, the Engineer may require additional testing before the use to determine compliance to requirements.

An anti-setting agent or a combination of anti-setting agents shall be incorporated in the curing compound to prevent caking.

The curing compound shall be packaged in clean barrels or steel containers or shall be supplied from a suitable storage tank located on the Site. Storage tank shall have a permanent system designed to completely redisperse any settled material without introducing air or any other foreign substance. Containers shall be well-sealed with ring seals and lug type crimp lids. The linings of the containers shall be of a character that will resist the solvent of the curing compound. Each container shall be labeled with a manufacturer's name, specification number, batch number, capacity and date of manufacture, and shall have label warning concerning flammability. The label shall also warn that the curing compound shall be well-stirred before use. When the curing compound is shipped in tanks or tank trunks, a shipping invoice shall accompany each load. The invoice shall contain the same information as that required herein for container labels.

Curing compound may be sampled by the Engineer at the source of supply and on the Site.

3. Waterproof Membrane Method

The exposed finished surfaces of concrete shall be sprayed with water, using a nozzle that so atomizes the flow that a mist and not a spray is formed until the concrete has set, after which a curing membrane of waterproof paper or plastic sheeting shall be placed. The curing membrane shall remain in place for a period of not less than 72 hours.

Waterproof paper and plastic sheeting shall conform to the specification of AASHTO M 171.

The waterproof paper or plastic sheeting shall be formed into sheets of such width as to cover completely the entire concrete surface.

All joints in the sheets shall be securely cemented together in such a manner as to provide a waterproof joint. The joint seams shall have a minimum lap of 100 mm.

The sheets shall be securely weighed down by placing a bank of earth on the edges of the sheets or by other means satisfactory to the Engineer.

Should any portion of the sheets be broken or damaged within 72 hours after being placed, the broken or damaged portions shall be immediately repaired with new sheets properly cemented into place.

Sections of membrane which have lost their waterproof qualities or have been damaged to such an extent as to render them unfit for curing, the concrete shall not be used.

4. Forms-In-Place Method

Formed surfaces of concrete may be cured by retaining the form-in-place. The forms shall remain in place for a minimum period of 7 days after the concrete has been placed, except that for members over 50 cm in least dimensions, the forms shall remain in place for a minimum period of 5 days. Wooden forms shall be kept wet by watering during the curing period.

5. Curing Cast-In-Situ Concrete

All newly placed concrete for cast-in-situ structures, other than highway bridge deck, shall be cured by the water method, the forms-in-place method, or as permitted herein, by the curing compound method, all in accordance with the requirements of Subsection, 407.3.8 Curing Concrete.

The curing compound method may be used on concrete surfaces which are to be buried under ground and surfaces where only Ordinary Surface Finish is to be applied and on which a uniform color is not required and which will not be visible from public view.

The top surface of highway bridge decks shall be cured by either the curing compound method or the water method. The curing compound shall be applied progressively during the deck finishing operations. The water cure shall be applied not later than 4 hours after completion of the deck finishing.

When deemed necessary by the Engineer during periods of hot weather, water shall be applied to concrete surface being cured by the curing compound method or by the forms-in-place method until the Engineer determine that a cooling effect is no longer required.

6. Curing Pre-Cast Concrete (except piles)

Pre-cast concrete members shall be cured for not less than 7 days by the water method or by steam curing. Steam curing for pre-cast members shall conform to the following provisions:

- a. After placement of the concrete, members shall be held for a minimum 4-hour pre-steaming period.
- b. To prevent moisture loss on exposed surfaces during the pre-steaming period, members shall be covered immediately after casting or the exposed surface shall be kept wet by fog spray or wet blankets.
- c. Enclosures for steam curing shall allow free circulation of steam about the member and shall be constructed to contain the live steam with a minimum moisture loss. The use of tarpaulins or similar flexible covers will be permitted, provided they are kept in good condition and secured in such a manner to prevent the loss of steam and moisture.
- d. Steam at jets shall be low pressure and in a saturated condition. Steam jets shall not impinge directly on the concrete, test cylinders, or forms. During application of the steam, the temperature rise within the enclosure shall not exceed 20°C per hour. The curing temperature throughout the enclosure shall not exceed 65°C and shall be maintained at a constant level for a sufficient time necessary to develop the required compressive strength. Control cylinders shall be

covered to prevent moisture loss and shall be placed in a location where temperature of the enclosure will be the same as that of the concrete.

- e. Temperature recording devices that will provide an accurate continuous permanent record of the curing temperature shall be provided. A minimum of one temperature recording device per 50 m of continuous bed length will be required for checking temperature.
- f. Curing of pre-cast concrete will be considered completed after the termination of the steam curing cycle.

7. Curing Pre-cast Concrete Piles

All newly placed concrete for pre-cast concrete piles, conventionally reinforced or prestressed shall be cured by the "Water Method" as described in Subsection 407.3.8, Curing Concrete, except that the concrete shall be kept under moisture for at least 14 days. At the option of the Contractor, steam curing may be used in which case the steam curing provisions of Subsection 407.3.8 (6), Curing Pre-Cast Concrete (except piles) shall apply except that the concrete shall be kept wet for at least 7 days including the holding and steaming period.

407.3.9 Falsework Design and Drawings

Detailed working drawings and supporting calculations of the false work shall be furnished by the Contractor to the Engineer. No falsework construction shall start until the Engineer has reviewed and approved the design. The Contractor shall provide sufficient time for the Engineer to complete this review. Such time shall be proportionate to the complexity of the falsework design and in no case be less than two weeks.

The Contractor may review the falsework drawings at any time provided sufficient time is allowed for the Engineer's review before construction is started on the revised portion.

Assumptions used in design of the falsework shall include but not be limited to the following:

1. The entire superstructure cross-section, except for the railing, shall be considered to be placed at one time, except when in the opinion of the Engineer, a portion of the load is carried by members previously cast and having attained a specified strength.
2. The loading used on timber piles shall not exceed the bearing value for the pile and shall in no case exceed 20 tonne per pile.
3. Soil bearing values and soil condition (wet and dry) shall be designated by the Contractor on the falsework drawings. Falsework footings shall be designed to carry the loads imposed upon them without exceeding estimated soil bearing values or allowable settlements.
4. The maximum loadings and deflections used on jacks, brackets, columns and other manufactured devices shall not

exceed the manufacture's recommendations. If requested by the Engineer, the Contractor shall furnish catalogue or other data verifying these recommendations.

5. If the concrete is to be prestressed, the falsework shall be designed to support any increased or readjusted loads caused by the prestressing forces.
6. Joints supporting slabs and overhangs shall be considered as falsework and designed as such.

For the construction of falsework over and adjacent to roadways where falsework openings are required for maintaining traffic, the Contractor shall provide any additional features for the work needed to insure that the falsework will be stable if subjected to impact by vehicles.

The falsework design at the locations where said openings are required shall include but not be limited to the following minimum provisions:

- a. Each exterior stringer in a span shall be securely anchored to the following cap or framing.
- b. Adequate bracing shall be used during all stages of falsework construction and removal over or adjacent to public traffic.
- c. Falsework members shall be at least 300 mm clear of temporary protective railing members.

The falsework drawings shall include a superstructure placing diagram showing proposed concrete placing sequence and construction joint locations, except that where a schedule for placing concrete is shown on the Contract Plans, no deviation will be permitted there from unless approved in writing by the Engineer.

The falsework drawings shall show pedestrian openings which are required through the falsework.

Anticipated total settlements of falsework and forms shall be indicated by the Contractor on the falsework drawings. These should include falsework footing settlements over 20 mm will not be allowed unless otherwise permitted by the Engineer. Deck slab forms between girders shall be constructed with no allowance for settlement relative to the girders.

Detailed calculations by the Contractor showing the stresses deflections, and camber necessary to compensate for said deflections in all load supporting members shall be supplied.

After approving the Contractor's falsework deflection camber, the Engineer will furnish to the Contractor the amounts of camber necessary to compensate for vertical alignment or anticipated structure deflection, if these are not shown on the drawings. The total camber used in constructing falsework shall be the sum of the aforementioned cambers.

407.3.10 Falsework Construction

The falsework shall be constructed to conform to the falsework drawings. The materials used in the falsework construction shall be of the quantity and quality necessary to withstand the stresses imposed. The workmanship used in falsework shall be of such quality that the falsework will support the loads imposed on it without excessive settlement or take-up beyond that shown on the falsework drawings.

When falsework is supported on piles, the piles shall be driven to a bearing value equal to the total calculated pile loading as shown on the falsework drawings.

Suitable jacks or wedges shall be used in connection with falsework to set the forms to their required grade and to take up any excessive settlement in the falsework either before or during the placing of concrete.

The Contractor shall provide tell-tales attached to the soffit forms easily readable and in enough systematically-placed locations to determine the total settlement of the entire portion of the structure where concrete is being placed.

Should unanticipated events occur, including settlements that deviate more than ± 20 mm from those indicated on the falsework drawings, which in the opinion of the Engineer would prevent obtaining a structure conforming to the requirement of the Specification, the placing of concrete shall be discontinued until corrective measures satisfactory to the Engineer are provided. In the event satisfactory measures are not provided prior to initial set of the concrete in the affected area, the placing of concrete shall be discontinued at a location determined by the Engineer. All unacceptable concrete shall be removed.

407.3.11 Removing Falsework

Unless otherwise shown on the drawings, or permitted by the Engineer, falsework supporting any span of a supported bridge shall not be released before 14 days after the last concrete, excluding concrete above the bridge deck, has been placed. Falsework supporting any span of a continuous or rigid frame bridge shall not be released before 14 days after the last concrete excluding concrete above the bridge deck, has been placed in that span and in the adjacent portions of each adjoining span for a length equal to at least half the length of the span where falsework is to be released.

Falsework supporting deck overhangs and deck slabs between girders shall not be released until 7 days after the deck concrete has been placed.

In addition to the above requirements, no falsework for bridges shall be released until the supported concrete has attained a compressive strength of at least 80% of the required 28-day strength. Falsework for cast-in place prestressed portion of structure shall not be released until after the prestressing steel has been tensioned.

All falsework materials shall be completely removed. Falsework piling shall be removed at least 50 cm below the surface of the original ground or stream bed. When falsework piling is driven within the limits of ditch or channel

excavation areas, the falsework piling within such areas shall be removed to at least 50 cm below the bottom and side slopes of said excavated areas.

All debris and refuse resulting from work shall be removed and the site left in a neat and presentable condition.

407.3.12 Formwork Design and Drawings

The Contractor shall prepare drawings and materials data for the formwork and shutters to be submitted to the Engineer for approval unless otherwise directed.

The requirements for design of formwork are the same as described under Section 407.3.9.

407.3.13 Formwork Construction

Concrete forms shall be mortar-tight, true to the dimensions, lines and grades of the structure and with the sufficient strength, rigidity, shape and surface smoothness as to leave the finished works true to the dimensions shown on the Plans or required by the Engineer and with the surface finish as specified.

Formwork and shutters are to be constructed in accordance with the approved Plans.

The inside surfaces of forms shall be cleaned of all dirt, mortar and foreign material. Forms which will later be removed shall be thoroughly coated with form oil prior to use. The form oil shall be of commercial quality form oil or other approved coating which will permit the ready release of the forms and will not discolor the concrete.

Concrete shall not be deposited in the forms until all work in connection with constructing the forms has been completed, all materials required for the unit to be poured, and the Engineer has inspected and approved said forms and materials. Such work shall include the removal of all dirt, chips, sawdust and other foreign material from the forms.

The rate of depositing concrete in forms shall be such to prevent bulging of the forms or form panels in excess of the deflections permitted by the Specification.

Forms for all concrete surfaces which will not be completely enclosed or hidden below the permanent ground surface shall conform to the requirements herein for forms for exposed surfaces. Interior surfaces of underground drainage structures shall be completely enclosed surfaces.

Formwork for concrete placed under water shall be watertight. When lumber is used, this shall be planed, tongued and grooved.

Forms for exposed concrete surface shall be designed and constructed so that the formed surface of the concrete does not undulate excessively in any direction between studs, joists, form stiffeners, form fasteners, or wales. Undulations exceeding either 2 mm or 1/270 of the center to center distance between studs, joists, form stiffeners, form fasteners, or wales will be considered to be excessive. Should any form of forming system, even

though previously approved for use, produce a concrete surface with excessive undulations, its use shall be discontinued until modifications satisfactory to the Engineer have been made. Portions of concrete structures with surface undulations in excess of the limits herein specified may be rejected by the Engineer.

All exposed surfaces of similar portions of a concrete structure shall be formed with the same forming material or with materials which produce similar concrete surface textures, color and appearance.

Forms for exposed surfaces shall be made of form materials of even thickness and width and with uniform texture. The materials shall have sharp edges and be mortar-tight.

Forms for exposed surfaces shall be constructed with triangular fillets at least 20 mm wide attached so as to prevent mortar runs and to produce smooth straight chamfers at all sharp edges of the concrete.

Form fasteners consisting of form bolts, clamps or other devices shall be used as necessary to prevent spreading of the forms during concrete placement. The use of ties consisting of twisted wire loops to hold forms in position will not be permitted.

Anchor devices may be cast into the concrete for later use in supporting forms or for lifting precast members. The use of driven types of anchorage for fastening forms or form supports to concrete will not be permitted.

407.3.14 Removal of Forms and Falseworks

Forms and falsework shall not be removed without the consent of the Engineer. The Engineer's consent shall not relieve the Contractor of responsibility for the safety of the work. Blocks and bracing shall be removed at the time the forms are removed and in no case shall any portion of the wood forms be left in the concrete.

Falsework removal for continuous or cantilevered structures shall be as directed by the Engineer or shall be such that the structure is gradually subjected to its working stress.

When concrete strength tests are used for removal of forms and supports, such removal should not begin until the concrete has attained the percentage of the specified design strength shown in the table below.

	Minimum Time	Minimum Percentage Design Strength
Centering under girders, beams frames or arches	14 days	80%
Floor slabs	14 days	70%
Walls	1 day	70%
Columns	2 days	70%
Sides of beams and all other vertical surfaces	1 day	70%

In continuous structures, falsework shall not be released in any span until the first and second adjoining spans on each side have reached the strength specified herein, or in the Special Specifications. When cast-in-place post

tensioned bridges are constructed, falsework shall remain in place until all post tensioning has been accomplished.

Falsework under all spans of continuous structures shall be completely released before concrete is placed in railings and parapets. In order to determine the condition of column concrete, forms shall be removed from columns before releasing supports from beneath beams and girders.

Forms and falsework shall not be released from under concrete without first determining if the concrete has gained adequate strength without regard to the time element. In the absence of strength determination, the forms and falsework are to remain in place until removal is permitted by the Engineer.

The forms for footings constructed within cofferdams or cribs may be left in place when, in the opinion of the Engineer, their removal would endanger the safety of the cofferdam or crib, and when the forms so left intact will not be exposed to view in the finished structure. All other forms shall be removed whether above or below the ground line or water level.

All forms shall be removed from the cells of concrete box girders in which utilities are present and all formwork except that necessary to support the deck slab shall be removed from the remaining cells of the box girder.

To facilitate finishing, forms used on ornamental work, railing, parapets and exposed vertical surfaces shall be removed in not less than 12 nor more than 48 hours, depending upon weather conditions. In order to determine the condition of concrete in columns, forms shall always be removed from them before the removal of shoring from beneath beams and girders.

Falsework and centering for spandrel-filled arches not be struck until filling at the back of abutments has been placed up to the spring line. Falsework supporting the deck of rigid frame structure shall not be removed until fills have been placed back to the vertical legs.

407.4 Method of Measurement

The quantity of structural steel, structural concrete, reinforcing steel, or other Contract Pay Items shall constitute the completed and accepted structure which shall be measured for payment in the manner prescribed in the several items involved..

407.5 Basis of Payment

The accepted quantities measured as prescribed in Section 407.4 Method of Measurement, shall be paid for at the contract unit price for each of the several pay items listed below that are included in the Bill of Quantities. The price and payment shall be full compensation for furnishing, preparing, fabricating, placing, and curing and for all labor, equipment, tools and incidentals necessary to complete the Item. Such payment shall constitute full payment for the completed concrete structure ready for use.

Payment will be made under:

Pay Item Number	Description	Unit of Measurement
407(8)	Lean Concrete (Class B, $f'c=16.50$ Mpa)	Cubic Meter

ITEM 412 ELASTOMERIC BEARING PADS

412.1 Description

412.1.1 Scope

This Item shall consist of the requirement for elastomeric bearing pads whose main function is to transfer loads or accommodate relative movement between a bridge superstructure and its supporting structure, or both while avoiding damaging strain and additional tension. Elastomeric bearings shall include unreinforced pads (consisting of elastomer only) and reinforced bearings with steel laminates.

412.1.2 General Requirements

All bearings shall be designed in accordance with specifications contained in the latest edition of the AASHTO Standard Specification for Highway Bridges, 15th Edition, 1992.

412.1.3 Classification and Use

The following are the types of elastomeric bearings:

- a. Plain Elastomeric Bearing Pad
- b. Plain Elastomeric Sandwich Bearing
- c. Steel-Laminated Elastomeric Bearing without External Load Plates
- d. Steel-Laminated Elastomeric Bearing with External Load Plate(s)

A laminated bearing pad is required when the thickness of the plain pad is more than 31.75 mm and the compressive strain is more than 15%.

412.2 Material Requirements

The elastomer for the manufacture of the bearing is furnished in two types as follows:

- 1) Type CR-Chloroprene Rubber
- 2) Type NR-Natural Rubber

The elastomer compound used in the construction of a bearing shall contain only either natural rubber or a chloroprene rubber as the raw polymer. No reclaimed rubber shall be used.

Steel laminates used for reinforcement shall be made from rolled mild steel conforming to ASTM A 36, A 570 or equivalent, unless otherwise specified by the Engineer. The laminates shall have a minimum nominal thickness of 20 gages.

412.2.1 Physical Requirements

- A. The elastomer compound shall meet the minimum requirement of Table 1.
- B. Dimensions and Permissible Variations

All elastomeric layers, for example, plain bearing pads, laminates, and covers, shall be of uniform thickness unless otherwise specified in the contract or purchase order.

All internal steel laminates shall be of uniform thickness. When specified in the contract or purchase order, the thickness of the outer steel laminates may differ if not adjacent to an external load plate.

The minimum thickness of internal steel laminates shall be 1.5 mm or 0.060 in (16 gage) when the greater of the length or width of a rectangular bearing or diameter of a circular bearing is less than 450 mm or 18 in. In all other cases, the minimum thickness shall be 2 mm or 0.075 inch (14 gage).

Bearing dimensions and elastomer layer thicknesses shall satisfy the tolerances in Table 2, in which D is the length, width or diameter as appropriate, and T is the total elastomer thickness.

Variation from a plane parallel to a design surface shall not exceed an average slope of 0.005 for the upper surface and 0.006 for a side surface.

Table 1 – Quality Control Properties of Elastomer

	Natural Rubber (NR)		Chloroprene Rubber (CR)	
Grade (Durometer)	60	70	60	70
Physical Properties:				
A. Before Aging				
Tensile Strength, MPa (D412)	15.5 (min.)	15.5 (min.)	15.5 (min.)	15.5 (min.)
Elongation, % (D412)	400 (min.)	300 (min.)	350 (min.)	300 (min.)
Durometer Hardness, Shore Pts. (D2240)	60±5	70±5	60±5	70±5
Tear Resistance, N/mm (D624)	31.5 (min.)	31.5 (min.)	31.5 (min.)	31.5 (min.)
Compression Set, % (D395)	25 (max.)	25 (max.)	35 (max.)	35 (max.)
Method B, Temperature, °C	70	70	100	100
B. After Aging				
Temperature of the Test, °C	70	70	100	100
Aging Time, Hours	168	168	70	70
Tensile Strength, % (D573)	-25 (max.)	-25 (max.)	-15 (max.)	-15 (max.)
Elongation, %	-25 (max.)	-25 (max.)	-40 (max.)	-40 (max.)
Durometer Hardness, Shore Pts.	+10 (max.)	+10 (max.)	+15 (max.)	+15 (max.)
Other Properties:				
Ozone Resistance (D1149)				
Partial Pressure, MPa	25	25	100	100
Duration, Hours	48	48	100	100

Tested at 20% strain 37.7 °C ±1 °C Mounting procedure D518	-	-	No cracks	No cracks
Procedure A Brittleness D2137, low temp. Brittleness at -40 °C	Pass	Pass	Pass	Pass
Shear Modulus Nominal Hardness Shear Modulus at 23 °C, MPa	0.85-1.1	1.13-1.84	0.85-1.1	1.13-1.84

Plain pads and laminated bearings shall be manufactured to the design dimensions and these specifications with the tolerances listed in Table 2, unless other tolerances are shown on the design drawings.

Table 2 – Tolerances

Design Dimensions /Parts	Mm
Overall vertical dimensions Design thickness 32 mm (1 ¼ in) or less Design thickness over 32 mm (1 ¼)	-0, +3 -0, +6
Overall horizontal dimensions 914 mm (36 in) and less Over 914 mm (36 in)	-0, +6 -0, +12
Thickness of individual layers of elastomer (laminated bearing only) at any point within the bearing	±20 percent of design value but no more than ±3 mm (1/8 in)
Variation from a plane parallel to the theoretical surface: (as determined by measurements at the edge of the bearings) Top	Slope relative to the bottom of no more than 0.005 radian
Sides	6
Position of exposed connection members	3
Edge cover of embedded laminated connection members	-0, +3
Size of holes, slots or inserts	±3
Position of holes, slots, or inserts	±3

412.3 Construction Requirements

412.3.1 Handling, Transport, Storage and Installation

During handling, transport, storage, and installation, bearings shall be kept clean and protected from mechanical damage, heat, contaminants and other deleterious effects.

Bearings shall be placed on surfaces that are plane to within 1.6 mm and unless the bearings are placed in opposing pairs, horizontal to within 0.01 radians.

Any lack of parallelism between the top of bearing and the underside of the girder that exceeds 0.01 radians shall be corrected either grinding of the surface, grout pack bearing seats or modification of the bearing such that the intended bearing placement is as originally designed with the least amount of bearing modification, or as otherwise directed by the Engineer.

Exterior plates of the bearing shall not be welded unless at least 38.1 mm of steel exists between the weld and the elastomer.

Each completed bearing shall have its components clearly identified, be securely bolted, straffed or otherwise fastened to prevent any relative movement and marked on its top as to location and orientation in each structure in the projects conformity with the plans.

Dismantling at the site shall not be done unless absolutely necessary for inspecting or installation.

412.3.2 Sampling

Sampling, testing and acceptance consideration will be made on a lot basis. A lot shall be further defined as the smallest number of bearings as determined by the following criteria:

- a. A lot shall not exceed a single contract or project quantity.
- b. A lot shall not exceed 50 bearings.
- c. A lot shall consist of those bearings of the same type regardless of load capacity.

For acceptance purposes, bearing from within the lot shall be selected at random as samples for inspection and testing.

A minimum of three bearings shall be taken from the lot for testing. If the number of bearings in the lot exceeds 50 then for each additional 50 or part thereof, one additional bearing shall be taken for testing.

412.3.3 Acceptance Requirements

1. If lack of elastomer to steel bond is indicated, the bearing shall be rejected.
2. If laminate placement faults are observed which results in elastomer layer thickness that exceed the tolerances in Table 2, the bearing shall be rejected.
3. If there are at least three separate surface cracks which are each at least 2 mm wide and 2 mm deep. The bearing shall be rejected.
4. Record the median compressive stiffness (K) of the bearing of median stiffness. The compressive stiffness of each bearing tested shall not differ from (K) by more than 10%.

5. For each bearing that fails to meet the requirements in (1), two additional bearings maybe sampled and shall meet the requirements in (1) or the lot shall be rejected.
6. If the lot is not rejected, the bearing of median stiffness (K) shall be subjected to the elastomeric material tests in (2).

412.4 Method of Measurement

The quantity of elastomeric bearing pad to be paid for will be the final quantity placed and accepted in the completed structure. The dimensions of elastomeric bearing pads will be the quantity placed in accordance with the Plans or as otherwise directed by the Engineer.

412.5 Basis of Payment

The accepted quantity, measured as prescribed in Section 412.4, shall be paid for at the contract unit price for Elastomeric Bearing Pads which price and payment shall be full compensation for furnishing and placing all materials, including all labor, equipment, tools and incidentals necessary to complete the work prescribed in this Item.

Payment will be made under:

Pay Item Number	Description	Unit of Measurement
412 (1)	Elastomeric Bearing Pads, DURO 60	Each

ITEM 507 – RUBBLE CONCRETE

507.1 Description

This item shall consist of the construction of rubble concrete in accordance with this specification and in conformity with the lines, grades, slopes and dimensions shown in the Plans or established by the Engineer.

507.2 Material Requirements

507.2.1 Stone

The stone shall be cleaned, hard, and durable and shall be subject to the Engineer's approval. Adobe stone shall not be used unless otherwise specified. Stones to be used shall be more than 0.015 cubic metre in volume and not less than 75 percent of the total volume of rock embankment and shall consist of stones 0.03 cubic metre in volume as described in Item 506.2. Stones obtained from excavation performed under this contract may be used.

507.2.2 Concrete Class "B"

Concrete shall be Class "B" in accordance with Item 405, Structural Concrete.

507.3 Construction Requirements**507.3.1 Preparation of Foundation Bed**

The foundation bed shall be excavated to the lines and grades as shown in the plans as directed by the Engineer, and shall be thoroughly compacted in accordance with Item 104.3.3.

507.3.2 Falsework and Formwork Construction

Falsework/formwork shall be constructed so as to withstand the stresses imposed.

Formwork used shall be constructed with sufficient strength, rigidity and shape as to leave the finished works true to the dimensions shown on the Plans and with the surface finished as specified.

The inside surface of the forms shall be cleaned of all dirt, water and foreign materials. Forms shall be thoroughly coated with form oil prior to use. The form oil shall be commercial quality form oil or other approved coating which will permit the ready release of forms and will not discolor the concrete.

507.3.3 Placing

One layer of concrete Class "B" shall be placed at the prepared bed prior to placing of stones. Clearance between stones shall not be less than 2-1/2 inches or the maximum size of concrete aggregate for Class "B".

Concrete Class "B" shall be placed after each layer of stone and shall be thoroughly consolidated by means of a vibrator inserted in each layer of concrete. In no case shall the vibrator be operated longer than 10 seconds in any location.

After removal of forms, any cavities, voids and honeycomb spots shall be filled up with mortar composed of one part cement and two parts sand.

All debris and refuse resulting from work shall be removed and the site left in a neat and presentable condition.

507.3.4 Weepholes

It shall conform to the requirements of Item 504, Riprap and Grouted Riprap under Subsection 504.3.4, Weepholes.

507.4 Method of Measurement

The quantity to be paid for shall be the number of cubic meters of rubble concrete complete in place and accepted. In computing the quantity of payment the dimension used shall be those shown on the plans or ordered in writing by the Engineer. No reduction shall be made for weepholes.

507.5 Basis of Payment

The quantity of rubble concrete determined as provided in the preceding section 507.4, Method of Measurement, shall be paid for at the contract unit price per cubic

meter for rubble concrete, which price and payment shall be full compensation for the preparation of the bed, furnishing, necessary excavations, falsework, and for all labor, equipment, tools and incidentals necessary to complete the Item.

Payment will be made under:

Pay Item Number	Description	Unit of Measurement
507 (1)	Rubble Concrete	Cubic Meter

ITEM 517 DRAIN PIPE

517.1 Description

This Item shall consist of furnishing and installing drain pipes, fastened with steel straps that are either bolted to pier copings, welded or fastened to girders in various locations of the bridge, or as indicated in accordance with this Specification and in conformity with the lines, and grades and dimensions shown in the Plans or as established by the Engineer.

Longitudinal drainage for bridges shall be provided by scuppers (catch basin) or drainpipe, which is of sufficient size and number to drain the storm water in the gutter adequately. Downspouts, where required, shall be made of rigid corrosion-resistant material not less than 150 mm in least dimension and should be provided with cleanouts. The details of drains shall such as to prevent the discharge of drainage water against any portion of the structure or on moving traffic below and to prevent erosion at the outlet of the downspout. Downspout shall be provided with pipe supports, where required on the Drawings.

The Contractor shall submit working drawings to the Engineer for his review. All working drawings shall show full detailed dimensions, sizes for all component parts of the structure. The required grade of steel for each individual steel fabrication shall be clearly indicated.

517.2 Material Requirements

Polyvinyl Chloride (PVC) pipe shall meet the requirements specified in one of the following specification: ASTM 3034, D 2241, D 1785, D 2665, D 2680, F 789, F 679 or AASHTO M 304M (D 2729).

Galvanized iron pipe shall meet the requirements specified in one of the following specifications: ASTM A53, AASHTO M 36 or M 218.

Steel strap shall meet the requirements of Item 712, Structural Metal; Item 409, Welded Structural Steel and Item 411, Paint, DPWH Standard Specifications, Volume II, Highways, Bridges and Airports.

Anchor bolts and bolts fasteners shall meet the requirement of Item 712, Structural Metal, DPWH Standard Specifications, Volume II, Highways, Bridges and Airports. 2013 edition.

Drain pipes for all bridges other than steel girder bridges shall be of standard galvanized iron pipe conforming to ASTM A501 with the diameter of 150 mm or as shown on the Drawing.

517.3 Construction Requirements

Drain pipes shall be constructed in accordance with the lines, dimensions and details shown on the Drawings or as directed by the Engineer. Drain pipe extension, if needed shall be attached to the ends of existing drain pipes either using pipe sleeves or pipe with bell sockets. The length of the extension shall depend on the existing drain pipe condition and the location as shown in the Plans and shall be lower than the required vertical clearance or as directed by the Engineer.

Pipes and fittings shall be homogenous throughout and free from visible cracks, holes, foreign inclusions or other injurious defects. Pipes installed shall be as uniform as commercially practical in color, opacity, density and other physical properties.

Fabrication of steel straps shall conform to the dimensions shown in the Plans and must be galvanized. Steel strap, unless otherwise specified, shall be coated with two shop coats of red lead paint and two field coats of paint as specified under Item 411, paint, DPWH Standard Specifications, Volume II, highways, bridges and Airports.

Anchor bolts shall be placed as provided under Item 403, metal Structures.

Welded connections shall conform to the requirements of Item 409, Welded Structural Steel, DPWH Standard specification, Volume II. Highways, bridges and Airports.

517.4 Measurement and Payment

Drain pipes shall be measured and paid on a linear meter basis, completed and accepted.

The quantities measured shall be paid for at the contract price for the Pay Items which price and payment shall be full compensation for furnishing and placing all materials and for all labor, equipment, tools, testing, supervision, transportation, shipping and storage costs, test assembly and all incidentals and appurtenances necessary to complete the work.

The payment shall be deemed to include full compensation for all additional materials and work not shown on the Drawings or specified, which are necessary to complete the installation.

Payment will be made under:

Pay Item Number	Description	Unit of Measurement
517(1)a	Drain Pipe 100 mm Diameter, (G.I Pipe including Pipe Fittings)	Linear Meter

ITEM 508 HAND-LAID ROCK EMBANKMENT**508.1 Description**

This Item shall consist of hand-laid rock embankment, as designated in the Bid Schedule, constructed in accordance with this Specification and in conformity with the lines and grades shown on the plans or established by the Engineer.

508.2 Material Requirements

Stones to be furnished and used shall be sound, clean, hard, and durable and in a well balanced range of sizes that would meet the requirements herein. Stones shall be approved by the Engineer. Unless otherwise specified on the Drawings, all stones shall be more than 0.015 cubic meter in volume and not less than 75 percent of the total volume of rock embankment shall consist of stone 0.03 cubic meter in volume. Stones obtained from excavation performed under this Contract may be used and shall be approved by the Engineer. Adobe stone shall not be used for the construction of rock embankment, unless otherwise specified. Broken concrete pieces 300 mm maximum size may be used with the approval of the Engineer.

508.3 Method of Measurement

The quantities to be measured and paid for shall be the number of cubic metre of hand laid rock embankment as indicated in the Bill of Quantities including stones furnished, place laid in position, completed and accepted by the Engineer.

508.4 Basis of Payment

The quantities determined in Section 508.3 Method of Measurement, will be paid for at the contract unit per cubic meter which price and payment shall constitute full compensation for excavation and preparation of bed, furnishing, selecting and transporting of stones, for placing stones by hand, backfilling or filling and for all labor, equipment, tools and incidentals necessary to complete the Item.

Payment will be made under:

Pay Item Number	Description	Unit of Measurement
508(1)	Hand-Laid Rock Embankment	Cubic Meter

ITEM SPL-801 PREMOLDED EXPANSION JOINT FILLER WITH SEALANT

Premolded expansion joint filler with sealant for concrete paving and structural construction shall conform to the applicable requirements of AASHTO M153.

PART G

DRAINAGE AND SLOPE PROTECTION STRUCTURES

ITEM 500 PIPE CULVERTS AND STORM DRAINS**500.1 Description**

This Item shall consist of the construction or reconstruction of pipe culvert and storm drains, hereinafter referred to as "conduit" in accordance with this Specification and in conformity with the lines and grades shown on the plans or as established by the Engineer.

500.2 Material Requirements

Material shall meet the requirement specified in the following specifications: Reinforced concrete culvert, storm drain and sewer pipe – AASHTO M 170

Joint Mortar – Joint mortar for concrete pipe shall consist of 1 part, by volume of Portland Cement and two (2) parts of approved sand with water as necessary to obtain consistency.

500.3 Construction Requirements**500.3.1 Excavation**

Trenches shall be excavated in accordance with the requirement of Item 103, Structure Excavation, to a width sufficient to allow for proper jointing of the conduit and thorough compaction of the bedding and backfill materials under and around the conduit.

500.3.2 Bedding

The minimum thickness of bedding material beneath the pipe shall be 100 mm. The bedding material shall be sand or selected sandy soil all of which a 9.5 mm sieve and not more than 10 percent of which passes a 0.075 mm sieve.

500.3.3 Backfilling

Materials for backfilling on each side of the conduit for the full trench width and to an elevation of 300 mm above the top of the conduit shall be fine, readily compactible soil or granular material selected from excavation or from an approved source, and shall not contain stones that would be retained on a 50 mm sieve, chunks of highly plastic clay, or other objectionable material. Granular backfill material shall have not less than 95 % passing a 12.5 mm sieve and not less than 95 % retained on a 4.75 mm sieve. Over size material, shall be removed from the backfill, except as directed by the Engineer.

500.4 Method of Measurement

The quantities to be paid for, for each class and diameter of new pipe culverts, shall be the lengths of pipes between the outside faces of the headwalls, measured along the axis of the pipes as, installed in place, completed and accepted.

500.5 Basis of Payment

The accepted quantities of conduit, determined as provided for in Section 500.4, Method of Measurement shall be paid for at the Contract unit price per linear meter for the conduit of the types and sizes specified and completed in place. The price and payment shall be full compensation for furnishing and placing all materials, including granular bedding and backfill and all labor, equipment, tools and incidentals necessary to complete the item.

Excavation for culverts, including excavation below flow line grade and for imperfect trench, shall be measured and paid for as provided in Item 103, Structure Excavation.

Payment will be made under:

Pay Item Number	Description	Unit of Measurement
500(1)a	RC Pipe Culvert, 460mm diameter Class II, Type B	Linear Meter
500(1)a3	RC Pipe Culvert, 910mm diameter Class II, Type B	Linear Meter

ITEM 502 MANHOLES, INLETS AND CATCH BASINS**502.1 Description**

This Item shall consist of the construction of manholes, inlets and catch basins in accordance with this Specification and to the lines, grades, dimensions and locations shown on the Drawings or as established by the Engineer.

502.2 Material Requirement

Unless otherwise indicated on the Drawings, concrete for these structures shall be concrete Class "A" and shall be in accordance with item 405, Structural Concrete, and reinforcing steel AASHTO M 31.

502.3 Method of Measurement

Excavation for manholes, inlets and catch basins will be measured and paid for as provided in item 103 Structure Excavation. No payment shall be made on areas over cut or excavated outside the specified section as shown in the Plan detail. shall be paid

502.4 Basis of Payment

Payment will be made under:

Pay Item Number	Description	Unit of Measurement
502 (1)a	Manhole (1.0m x 1.0m) for 460mm diameter RCPC	Each
502 (1)a7	Manhole (1.50m x 1.50m) for Lateral Drains	Each
502 (3)a3	Catch Basin , 910mm diameter	Each
502 (4)a	Concrete Cover for Manhole (1.0m x 1.0m Manhole)	Each
502 (4)a7	Concrete Cover for Manhole (1.5m x 1.5m Manhole)	Each

ITEM 505 RIPRAP AND GROUTED RIPRAP**505.1 Description**

This Item shall consist of furnishing and placing of riprap with grout in accordance with this Specification and to the lines, grades and dimensions shown on the Drawings. This work also includes construction of weep holes.

505.2 Material Requirements**505.2.1 Stones**

Cobbles and boulders for Class A riprap shall consist of rock as nearly rectangular in section as is practicable or round natural stones ranging from 200mm to 250mm in diameter. Boulders shall be sound, tough, durable, dense, resistant to the action of air and water, and suitable in all aspects for the purpose intended.

505.2.2 Filter Materials

For weep-hole, non-woven geotextiles sewed like a bag and filled with gravel, 20 mm diameter, in accordance with DPWH standards shall be used as filter as shown in the Drawings.

The PVC pipe shall be durable and of accepted quality and shall be subject to the approval of the Engineer. Unless otherwise shown on the drawing the pipe shall be schedule 40 and minimum 50mm diameter.

505.2.3 Mortar

Mortar for grouted riprap shall be one (1) part cement to three (3) parts sand by volume and enough water to obtain the required consistency and shall conform to the requirements of Item 405, Structural Concrete.

505.3 Construction Requirements**505.3.1 Excavation**

The bed for grouted riprap shall be excavated to the required depths and to the design slope properly compacted, trimmed and shaped as shown on the Drawings.

The grouted riprap shall be founded in a toe trench dug below the depth of scour as shown on the Drawings or as ordered by the Engineer. The toe trench shall be filled with stones of the same class as that specified for the grouted riprap, unless otherwise specified.

505.3.2 Placing

The stones shall be laid by hand or individually by machines. They shall be laid with close, broken joints and shall be firmly bedded into the slope and against the adjoining stones. Each stone shall be laid in close contact with each adjacent stones. The riprap shall thoroughly be rammed into place as construction progresses and the finished surface shall present an even, tight surface. Interstices between stones shall be filled with small broken fragments firmly rammed into place. The surface of the riprap shall not vary from the theoretical surface by more than 100mm at any point.

505.3.3 Grouting

Sufficient mortar shall be used to completely fill all spaces between stones throughout the thickness of the riprap except that the face surface of the stones shall be left exposed. Grout shall be placed from bottom to top of the surface and swept with a stiff broom. After grouting is completed, the surface shall be cured as specified in Item 405, Structural Concrete for a period of at least three days. Hardened grout left during the previous days' operation shall be cleaned thoroughly from earth or dust and other unnecessary materials with water and broom before another layer of stone and grout is added.

505.4 Method of Measurement

Riprap and grouted riprap shall be measured by the number of cubic metre in place, completed and accepted by the Engineer in accordance with the Drawings. Only accepted work will be measured for payment and the computation of the quantity thereof will be based on the volume within the limiting dimensions designated on the Drawings or as determined by the Engineer. No separate measurement shall be made for filter materials.

505.5 Basis of Payment

The quantities measured as provided under Sub-Section 505.4, Method of Measurement shall be paid for at the Contract unit price as listed in the Bill of Quantities, which price and payment shall be full compensation for excavation and preparation of the bed, for furnishing and placing all materials including weep holes, filter materials, backfill, and additional fill to bring the riprap bed to the line, grades and dimension as shown on the Drawings and for all labor, equipment, tools and incidentals necessary to complete the work Item.

Payment will be made under:

Pay Item Number	Description	Unit of Measurement
505(2)a	Grouted Riprap, Class A	Cubic Meter

ITEM 506 STONE MASONRY**506.1 Description**

This Item shall consist of stone masonry in minor structures, in headwall for culverts, in retaining walls at the toes of slope, and at other places called for on the plans, constructed on the prepared foundation bed, in accordance with this Specification and to the lines, grades and dimensions shown on the Drawings. This work also includes construction of weep holes.

506.2 Material Requirements**506.2.1 Stone**

Stones shall be clean, hard and durable and shall be subject to the approval of the Engineer. Unless otherwise specified on the Drawings or as directed by the Engineer, stones for masonry shall be Class A as described in Item 504, Riprap and Grouted Riprap. Stones shall have roughly similar blunted ends.

506.2.2 Mortar

The mortar for stone masonry shall be composed of one (1) part Portland cement to two (2) parts of sand by volume and sufficient water to obtain the required consistency and shall conform to the requirements of materials under Item 405, Structural Concrete.

506.3 Construction Requirement**506.3.1 Selection and Placing**

Care shall be taken to prevent the bunching of small stone or stones of the same size. Large stones shall be used in the corners.

All stones shall be cleaned thoroughly and wetted immediately before being set, and the bed shall be cleaned and moistened before the mortar is spread. They shall be laid with their longest faces horizontal in full beds of mortar, and the joint shall be flushed with mortar.

506.3.2 Weepholes

It shall conform to the requirement of item 504, Riprap and Grouted Riprap.

506.3.3 Cleaning Exposed Faces

Immediately after being laid, all outside face stone shall be thoroughly cleaned of mortar stains and shall be kept clean until the work is completed.

506.4 Method of Measurement

Stone Masonry shall be measured by the number of cubic meter in place, completed and accepted by the Engineer in accordance with the Drawings. Only accepted work will be measured for payment and the computation of the quantity thereof will be based on the volume within the limiting dimensions designated on the Drawings or as determined by the Engineer. No separate measurement shall be made for filter materials.

506.5 Basis of Payment

The quantities measured as provided under Sub-Section 506.4, Method of Measurement shall be paid for at the Contract unit price as listed in the Bill of Quantities, which price and payment shall be full compensation for excavation and preparation of the bed, for furnishing and placing all materials including weep holes, filter materials, backfill, and additional fill to bring the riprap bed to the line, grades and dimension as shown on the Drawings and for all labor, equipment, tools and incidentals necessary to complete the work item.

Payment will be made under:

Pay Item Number	Description	Unit of Measurement
506(1)	Stone Masonry	Cubic Meter

PART H

MISCELLANEOUS STRUCTURES

PART H MISCELLANEOUS STRUCTURES**ITEM 600 CURB AND GUTTER****600.1 Description**

This Item shall consist of the construction of curb and gutter either Precast or Cast in place, made of concrete in accordance with this Specification at the location, and in conformity with the lines, grades, dimensions and design, shown on the Plans or as required by the Engineer.

600.2 Material Requirements**600.2.1 Material for Bed Course**

Bed course materials as shown on the plans shall consist of cinder, sand, slag, gravel, crushed stone, or other approved porous material of such grading that all the particles will pass through 12.5 mm sieve.

600.2.2 Concrete

Concrete shall be of the class indicated on the Plans and shall conform to the requirements of Item 405, Structural Concrete.

600.2.3 Expansion Joint Filler

Expansion joint shall be conform to the requirements of AASHTO M 153/Item 705.

600.2.4 Cement Mortar

Cement mortar shall consist of one part of Portland cement and two parts of fine aggregates with water added as necessary to obtain the required consistency. The mortar shall be used within 30 minutes of preparation.

600.2.5 Bonding Compound

Where bonding compound is used, it shall conform to AASHTO M 200.

600.3 Construction Requirements**600.3.1 Bedding**

Excavation shall be made to the required depth and the base upon which the curb and/or gutter is to be set shall be compacted to a firm and even surface. All soft and unsuitable material shall be removed and replaced with suitable material.

Bed course material shall be placed and compacted to form a bed of the required thickness as shown on the Plans.

600.3.2 Cast in Place Curb and Gutter

600.3.2.1 Placing

Forms shall conform to the requirements of Item 407, Concrete Structures. Metal forms shall be of an approved section.

Forms to hold the concrete shall be built and set-in-place as described in Item 407, Concrete Structures. Forms for at least 50 m of curb and gutter shall be in-place and checked for alignment and grade before concrete is placed. Curbs and gutters constructed on curves shall have forms of either wood or metal and they shall be accurately shaped to the curvature shown on the Plans.

Mixing, Placing, Finishing and curing of concrete shall conform to the requirements of Item 405, Structural Concrete, as modified by the requirements below.

The concrete shall be placed in the forms in layers of 100 or 125 mm each, and to the depth required. It shall be tamped and spaded until mortar entirely covers the top and surfaces of the forms. The top of the concrete shall be finished to a smooth and even surface and the edges rounded to the radii shown on the Plans. Before the concrete is given the final finishing, surface of the gutter shall be tested with a 3-m straight-edge and any irregularities of more than 10 mm in 3 m shall be corrected.

The curb and gutter shall be constructed in uniform section of not more than 50 m in length except where shorter sections are required to coincide with the location of weakened planes or contraction joints of 2 m long. The sections shall be separated by sheet templates set perpendicular to the face and top of the curb and gutter. The templates shall be approximately 5 mm in thickness and of the same width as that of the curb and/or gutter and not less than 50 mm deeper than the depth of the curb and/or gutter. Templates shall be set carefully and held firmly during the placing of the concrete and shall remain in place until the concrete has set sufficiently to hold its shape but shall be removed while the forms are still in place. A preformed joint filler approved by the Engineer may be used in lieu of the sheet template mentioned above. In this event the fiber board shall be pre-cut to the shape of the curb so that its outer edge will be flushed with the abutting curb and/or gutter.

Expansion joint shall be formed at intervals shown on the Plans. Where a curb is placed next to a concrete pavement, expansion joints in the curb shall be located opposite expansion joints in the pavement.

The form shall be removed within 24 hours after the concrete has been placed. Minor defects shall be repaired with mortar containing one part of Portland cement and two parts of fine aggregate. Plastering shall not be permitted and all rejected portions shall be removed and replaced at the Contractor's expense. The exposed surface shall be wetted soft brick or wood until they are smooth. The surfaces shall be wetted thoroughly, either by dipping the brick or wood in water, or by throwing water on the surfaces with a brush. After the concrete has been rubbed smooth using water, it shall

then be rubbed with a thin grout containing one part of Portland cement and one part of fine aggregates. Rubbing with grout shall continue until uniform color is produced. When completed, the concrete shall be covered with suitable material may be applied as provided in Item 405, Structural Concrete. The concrete shall be suitably protected from the weather until thoroughly hardened.

After the concrete has set sufficiently, the spaces on the back of the curb which were excavated for placing the curb shall be refilled to the required elevation with suitable material which shall be tamped in layers of not more than 150 mm until consolidated.

600.3.3 Precast Curb and Gutter

600.3.3.1 Placing

The precast concrete curb and gutter shall be set in 20 mm of cement mortal as specified in Subsection 600.2.4 to the line level and grade as shown on the approved Plans.

The precast curb shall not be more than 20 cm in width at the top portion and not be more than 25 cm at the base. The precast curb and gutter shall be 1.0 m in length and shall be put side consecutively with joint in between.

Joints between consecutive curb and gutter shall be filled with cement mortar to the full section of the curb and gutter. Expansion joints shall be formed at intervals shown on the Plans. Where a curb and gutter is placed next to a concrete pavement, expansion joints in the curb and gutter shall be located opposite expansion joints in the pavement.

Minor defects shall be repaired with mortar containing one part of portland cement and two parts of fine aggregates. Plastering shall not be permitted and all rejected portions shall be removed and replaced at the contractor's expense. The exposed surface shall be finished by rubbing the surfaces with a wetted soft brick or wood until they are smooth. The surfaces shall be wetted thoroughly, either by dipping the brick or wood in water, or by throwing water on the surfaces with a brush. After the concrete has been rubbed smooth using water, it shall then be rubbed with a thin grout containing one part of Portland cement and one part of fine aggregate. Rubbing with grout shall continue until uniform color is produced.

600.3.3.2 Handling Precast Curb and Gutter

1. In preparation for the handling of precast curb and gutter, all fabricated curb and gutter of one (1) meter in length shall be provided or inserted with 2(25 mm) Ø PVC pipes for fitting at their required locations. The PVC pipes shall be placed 25 mm from both edge during the plastic state of fresh concrete.

2. Precast curb and gutter shall be lifted on upright position and not at the points of support and shall be the same during transporting and storage.
3. Extreme care shall be exercised in handling and moving precast curb and gutter to avoid cracking.
4. No precast curb and gutter shall be used that does not reach its final position in the forms with the required time stipulated prior to installation.
5. Precast curb and gutter shall be transferred to the construction site. Fresh curb and gutter shall not be placed against in-situ concrete which has been in a position for more than 30 minutes.
6. Precast curb and gutter may only be transported to the delivery point in truck agitators truck mixer operating at the speed designated by the manufacturer of the equipment, provided that the consistency and workability of the mix concrete upon discharge at the delivery point is suitable for adequate placement.

600.4 Method of Measurement

The length of curb and gutter to be paid shall be the number of linear meters of curb and gutter (cast in place) or the number of pieces of precast curb and gutter of the required dimension shown on the Plans measured along its front face in-place, completed and accepted. No deductions shall be made for flattening of curbs at entrances and no additional allowances shall be made for curbs and gutters constructed on curves.

600.5 Basis of Payment

The length of curb and gutter determined in Subsection 600.4, Method of Measurement, shall be paid for at the contract unit price per linear meter for curb and gutter which price and payment shall constitute full compensation for furnishing and placing all materials for concrete, forms for drainage openings, excavation for curb and gutter, backfilling, dumping and disposal of surplus materials, and for all labor, equipment, tools and incidentals necessary to complete the Item.

Payment will be made under:

Pay Item Number	Description	Unit of Measurement
600(1)	Concrete Curb (Cast in Place)	Linear Meter
600(4)	Combination Curb and Gutter (Cast in Place)	Linear Meter

ITEM 601 SIDEWALK**601.1 Description**

This Item shall consist of the construction of asphalt or portland cement concrete sidewalk in accordance with this Specification and to the lines, grades, levels and dimensions shown on the Plans, or as required by the Engineer.

601.2 Material Requirements**601.2.1 Portland Cement Concrete**

The cement concrete shall be Class A as specified in Item 405, Structural Concrete.

601.2.2 Asphalt

Asphaltic material shall be specified in Item 308, Bituminous Plant-Mix Surface Course, Cold-Laid, or Item 310, Bituminous Concrete Surface Course, Hot-Laid.

601.2.3 Expansion Joint Filler

Unless otherwise ordered, the preformed joint filler shall have a thickness of 5 mm and shall conform to the requirements of Item 311, Portland Cement Concrete Pavement.

601.2.4 Forms

Forms shall be of wood or metal as approved by the Engineer and shall extend to the full depth of the concrete. All forms shall be straight, free from warps and of adequate strength to resist distortion.

601.2.5 Bed Course Material

Bed course material consists of cinders, sand, slag, gravel, crushed stone or other approved permeable granular material of such grading that all particles shall pass a 12.5 mm (1/2 inch) sieve.

601.2.6 Asphaltic Prime Coat

Prime coat shall be cut-back asphalt conforming to the requirements of Item 301, Bituminous Prime Coat.

601.3 Construction Requirements**601.3.1 Asphalt Sidewalk**

Excavation shall be made to the depth and width required that will permit the installation and bracing of the forms. The foundation shall be shaped and compacted to a firm and even surface conforming to the section shown on the Plans. All materials from soft areas shall be removed and replaced with suitable materials.

The bed course shall be compacted in layers not exceeding 100 mm to the depths, lines and levels shown on the Plans.

The prepared bed course material shall receive an application of prime coat in accordance with the requirements of Item 301, Bituminous Prime Coat.

The asphalt mixture shall be placed on the previously primed and prepared bed only when, in the opinion of the Engineer, the bed is sufficiently dry and weather conditions are suitable. The mixture shall be placed in one or more layers of uniform thickness to the total depth shown on the Plans. Each layer shall be smoothed by raking or screeding and shall be thoroughly compacted by rolling with a hand operated roller of a type satisfactory to the Engineer. After compaction, the surfacing shall be of the thickness and section shown on the Plans and shall be smooth, even and of a dense uniform texture. Forms, if used, shall be removed and the shoulders shaped and compacted to the required section.

601.3.2 Cement Concrete Sidewalk

Excavation shall be as specified above. The bed course material shall be placed in accordance with the Item 200, Aggregate Subbase Course.

All forms shall be staked securely in position at the correct line and level. Performed joint filler shall be set in position shown on the Plans before placing of the concrete is started. The top of the joint filler shall be placed 5 mm below the top surface of the finished sidewalk.

The mixing, placing, finishing and curing of concrete shall be as specified in Item 405, Structural Concrete. The Portland cement concrete shall be placed to the total depth shown on the Plans.

The surface shall be cut through to a depth of 10 mm with a trowel at intervals of 1 m or, were required, in straight lines perpendicular to the edge of sidewalk. The surface shall then be brushed. The edges of the sidewalk and the transverse cuts shall be shaped with a suitable tool so formed as to round the edges to a radius of 15 mm.

601.4 Method of Measurement

The area to be paid for shall be the number of square meters of sidewalk measured, completed in-place and accepted.

601.5 Basis of Payment

The quantity as determined in Subsection 601.4, Method of Measurement, shall be paid for all the contract unit price per square meter for Sidewalk which price and payment shall constitute full compensation for furnishing and placing all materials for asphalt sidewalk, concrete sidewalk, expansion joint material, for excavating and compacting the foundation bed, for furnishing and placing cinders, gravel or other permeable bed course material, for prime coat material, for forms and for all labor, equipment, tools and incidentals necessary to complete the Item.

Payment will be made under:

Pay Item Number	Description	Unit of Measurement
601(1)a	Reinforced Concrete Sidewalk 0.10m thk. With Homogeneous Granite Tile Finished	Square Meter
601(1)b	Reinforced Concrete Sidewalk 0.10m thk. With Colored Cement Finished	Square Meter
601(1)c	Sidewalk Concrete Plank Paver Finished (0.125m x 0.368m, Dark Gray)	Square Meter

ITEM 602 MONUMENTS, MARKERS AND GUIDE POSTS

602.1 Description

This item shall consist right-of-way monuments, maintenance marker posts, kilometer posts, drainage marker post and/or guide posts, furnished and installed in accordance with this Specification at the locations, and in conformity with the sizes, dimensions and design, shown on the plans, or as required by the Engineer.

602.2 Materials Requirement

Unless otherwise indicated on the Drawings, concrete shall be Class "A" and shall be composed of materials conforming to the requirements of Item 405, Structural Concrete

Reinforcing steel shall conform to the requirements of item 404, Reinforcing Steel.

The metal material shall conform to the requirements shown on the Plans, or as stipulated in the Special Provisions.

Paints, if required, shall conform to the requirements shown on the Plans, or as stipulated in the Special Provisions.

Warning reflectors, if required, shall conform to the requirements shown on the Plans, or as stipulated in the Special Provisions.

602.3 Construction Requirements

Construction or fabrication and installation of monuments and posts shall be as shown on the plans and shall include the attaching of warning reflectors and the painting of posts, if required. Each monument and post shall be set accurately at the required location and elevation and in such manner as to insure its being held firmly in place. In constructing pre-cast monuments, the forms shall not be removed until after the concrete has hardened. Monuments that are warped shall be rejected. The exposed surface of the finished monuments shall be uniform or even texture, and shall be free from holes, cracks and chipped edges. The precast monuments shall not be transported to the work until the concrete has been cured.

602.4 Method of Measurement

The quantities to be paid for shall be the actual number of kilometer post and drainage marker furnished, placed and accepted.

602.5 Basis of Payment

Wood post shall be fabricated from an approved or specified timber specie and shall be of the quality, diameter or section and length as specified, or as shown on the Plans.

Steel post shall be of the section and length as specified, or as shown on the Plans. They shall be of a copper bearing steel when so specified. Steel shall conform to the requirements of AASHTO M 183 for the grade specified. The posts shall be galvanized or shop painted as may be specified.

Pre-cast reinforced concrete posts shall be of a section and length as specified or as shown on the Plans. Concrete shall conform with the requirements of Item 405, Structural Concrete, for class specified. Reinforcement shall conform with the requirements of AASHTO M 31 Grade 60. All bars shall be of the deformed type.

Concrete deadmen for end anchorages shall be as specified, or as shown on the Plans. Concrete and reinforcement shall conform to the requirements as stated above the precast reinforced concrete posts.

Paints for steel and wood shall be specified and conform to the requirements specified in Item 411, Paint.

603.3 Construction Requirements

603.3.1 Posts

Post shall be set vertically in the position shown on the Plans and, where embedded in a concrete foundation block, shall remain undisturbed for a minimum of 48 hours. The space around the post shall be backfilled to the ground line with approved materials in layers of exceeding 100mm and each layer shall be moistened and thoroughly compacted

603.3.2 Rail Elements

Rail elements shall be erected in a manner resulting in a smooth continuous installation. All bolts, except adjustment bolts, shall be drawn tight. Bolts shall be of sufficient length to extend beyond the nuts at least 5mm but not more than 10mm.

Where painting of railing components is specified, any damage to the shop coat of paint shall be corrected by an application of an approved rust-inhibitive primer prior to further painting. Any surface inaccessible to painting after erection shall be given the specified number of coats of paint uniformly applied by thorough brushing using an approved pressure spray.

Galvanized surfaces which have been abraded so that the base material is exposed, threaded portions of all fittings and fasteners and cut ends of bolts shall be protected in a manner as may be specified or directed by the Engineer.

The surfaces and sawed edges of untreated or salt-treated guardrail shall be painted with three coats of white paint to within 200 mm of the ground line. The first 200 mm of posts above the ground shall be painted with two coats of black paint. Painting shall be done only when the timber is dry and clean. Each coat of paint shall be thoroughly dry before the next coat is applied. Paint shall be applied in heavy coats, completely covering every part of the surface and

shall be worked well into the joints and open spaces. It shall be thoroughly and evenly spread that no excess paint collects at any point.

Guardrail and posts, after erection has been completed, shall be stained with two applications of approved creosote stain, covering the rails and the exposed portions of the posts. The wood shall be dry before being stained. The first coat shall be thoroughly dry before the second is applied. Stain shall not be applied in damp weather.

For beam type guardrails, metal works not galvanized shall be given one shop coat of red lead, zinc chromate paint or an approved fast-drying rust-inhibitive primer and two field coats of white or aluminum paint. Untreated wood posts shall be given three coats of paints of the color indicated on the Plans, or as specified. Painting shall conform to the requirements of Item 411, Paint.

603.4 Method of Measurement

Guardrail shall be measured by linear meter from center to center of end post except where end connections are made on masonry or steel structures, in which case measurement will be to the face of such structures.

Terminal sections or end pieces will be measured as units of each kind as shown on the Bill of Quantities. If no pay item for anchorages or terminal sections appear in the Bid Schedule, measurement therefore shall be included in the linear meter measurement of completed guardrail.

603.5 Basis of Payment

The accepted quantities of guardrail, determined in Subsection 603.4 Method of Measurement, shall be paid for at the contract unit price per linear meter for the type specified, completed in place.

Payment will be made under:

Pay Item Number	Description	Unit of Measurement
603 (3)a1	Metal Guardrail (Metal Beam), with Post	Linear Meter
603 (4)a	Metal Beam, End Piece	Each

ITEM 604 FENCING

604.1 Description

This Item shall consist of furnishing and constructing posts and barbed wire or chain link fences in accordance with the details, and at the locations, shown on the Plans, or as required by the Engineer.

604.2 Material Requirements

604.2.1 Barbed Wire

Barbed wire shall conform to the requirements of ASTM A 121, Class I. The barbed wire shall consist of 2 strands of 12.5 gauge wire, twisted with 2 points, 14 gauge barbs spaced 100 mm apart.

604.2.2 Chain Link Fence Fabric

Chain link fence fabric shall be fabricated from 10 gauge galvanized wire conforming to AASHTO M 181 and shall be of the type shown on the Plans. Before ordering the chain link fence fabric, the Contractor shall submit a sample of the material to the Engineer for testing and for approval.

604.2.3 Concrete Post

Concrete posts shall be made of Class A concrete in accordance with Item 405, Structural Concrete. The posts shall be cast to a tapered section 3 m long, or to the length shown on the detailed Plans, and shall have a smooth surface finish.

604.2.4 Steel Post

Steel posts shall be of the sections and length as specified or as shown on the Plans. The posts shall be copper bearing steel and shall conform to the requirements of AASHTO M 183 for the grade specified.

604.2.5 Hardware

Nuts, bolts, washer and other associated hardware shall be galvanized after fabrication as specified in ASTM A 153.

604.3 Construction Requirements

The Contractor shall perform such clearing and grubbing as may be necessary to construct the fence to the required grade and alignment.

Fence shall generally follow the contour of the ground. Grading shall be performed where necessary to provide a neat appearance.

604.3.1 Erection Post

The post shall be erected vertically in position inside the formwork of the foundation block prior to the placing of concrete and shall be adequately support by bracing to prevent movement of the post during the placing and setting of the concrete. The posts shall be erected to the height and location shown on the Plans. or as ordered by the Engineer.

604.3.2 Installation of Chain Link Fence Fabric

The chain link fence fabric shall be set to line and elevation, and pulled taut between each post before spot welding or other method of fixing, is carried out. Where splicing of the fence fabric is necessary, or at joints, the lapping of the chain link fabric shall be for a minimum of 100 mm and shall occur only at the post. No horizontal splicing will be permitted. The fence fabric shall be fixed to the posts as shown on the Plans. Any surface protective layer damaged during welding and/or construction shall be restored properly.

604.4 Method of Measurement

The quantity to be paid for shall be the number of linear meters measured center to center of posts of fencing erected in place and accepted.

604.5 Basis of Payment

The quantity, as determined in Section 604.4, Method of Measurement, shall be paid for at the contract price per unit of measurement respectively for each of the particular items listed below and as shown in the Bid Schedule, which price and payment shall be full compensation for furnishing and placing all materials and for all labor, equipment, tools and incidentals necessary to complete the Item.

Payment will be made under:

Pay Item Number	Description	Unit of Measurement
604 (2)	Fencing (Chain Link Fence Fabric) Including Pedestal	Linear Meter

ITEM 605 ROAD SIGNS

605.1 Description

This item shall consist of furnishing and installing road signs in accordance with this Specification, at the locations, and in conformity with the lines and grades shown on the Plans, or as required by the Engineer.

Road sign shall be classified as standard or non-standard. Standard signs consist of all warning signs, regulatory signs and informative signs with the exception of direction signs, place identification signs and the line. Non-standard signs consists of all informatory signs which as not classified as standard signs.

605.2 Materials Requirement

605.2.1 Sign Panels

Sign panels for warning, regulatory, and informatory signs shall be manufactured from aluminum sheeting at least 3 mm thick.

605.2.2 Reflective Sheeting

Table 605.1 – Reflective Brightness of Traffic Signs Surfaces

Color	Angle of Incidence	Angle of Divergence	Minimum Reflective Brightness Value Compared with MgO
Red	-4°	0.5°	15
	20°	0.5°	10
	50°	0.5°	3
White	-4°	0.5°	75
	20°	0.5°	70
	50°	0.5°	70
Yellow	-4°	0.5°	35
	20°	0.5°	35
	50°	0.5°	10
Blue	-4°	0.5°	6
	20°	0.5°	4.5

	50 ⁰	0.5 ⁰	0.5
Green	-4 ⁰	0.5 ⁰	6
	20 ⁰	0.5 ⁰	4.5
	50 ⁰	0.5 ⁰	0.5

605.2.3 Post and Frames

Posts for road signs shall be either G.I. pipe conforming to ASTM A 283 Grade D. In lieu of wide flange steel posts, the Contractor may use tubular steel posts conforming to ASTM A 501. All posts shall be thoroughly cleaned, free from grease, scale and rust and shall be given one coat of rust inhibiting priming paint and two coats of gray paint in accordance with Item 411, Paint.

Other structural steel members shall conform to ASTM A 283 Grade D.

605.2.4 Nuts and Bolts

Nuts, bolts, washers and other metal parts shall be hot-dip galvanized after fabrication in accordance with the requirements of AASHTO M 111.

605.2.5 Concrete Foundation Blocks

The concrete for the foundation blocks shall be class A in accordance with item 405, Structural Concrete and shall be of the size shown on the plans.

The exposed portions of the fastening hardware on the face of the signs shall be painted with enamel matching the background color.

605.3 Construction Requirements

605.3.1 Excavation and Backfilling

Hole shall be excavated to the required depth to the bottom of the concrete foundation as shown on the Plans.

Backfilling shall be carried out by using suitable material approved by the Engineer and shall be compacted in layers not exceeding 150mm in depth. Surplus excavated material shall be disposed of by the Contractor as directed by the Engineer.

605.3.2 Erection of Posts

The post shall be erected vertically in position inside the formwork of the foundation block prior to the placing of the concrete and shall be adequately supported by bracing to prevent movement of the post during the placing and setting of concrete. The post shall be located at the positions shown on the Plans.

605.3.3 Sign Panel Installation

Sign panels shall be installed in accordance with the details shown on the Plans. Any chipping or bending of the sign panels shall be considered as sufficient cause to require placement of the panels at the Contractor's expense.

The exposed portion of the fastening hardware on the face of the signs shall be painted with enamels matching the background color.

All newly erected traffic road signs shall be covered until ordered removed by the Engineer.

605.4 Method of Measurement

The quantities of standard reflective warning and regulatory signs shall be the number of such signs of the size specified, including the necessary posts and supports erected and accepted.

605.5 Basis of Payment

The accepted quantities of road signs, determined in Subsection 605.4 Method of Measurement, shall be paid for at the contract unit price per unit for the type specified, completed in place.

Payment will be made under:

Pay Item Number	Description	Unit of Measurement
605 (1)c2	Warning Signs, 750mm Triangle (W1- 3B) (Curve Sign)	Each
605 (1)g3	Warning Signs, 750mm Triangle (W2- 1C) (T-Junction)	Each
605 (1)j3	Warning Signs, 750mm Triangle (W2- 4C) (Cross Road)	Each
605 (2)r2	Regulatory Signs, 600mm Circle (R4 -1B) (Speed Limit Sign)	Each
605 (3)	Guide or Informative Signs, 800mm x 1200mm Rectangle (Load Limit Sign)	Each
605 (3)a2	Guide or Informative Signs, 960mm x 2100mm Rectangle (G1-2, Advance Direction Sign)	Each

ITEM 612 REFLECTIVE THERMOPLASTIC STRIPPING MATERIAL (SOLID FORM)

612.1 Description

This standard specifies the requirement for reflectorized thermoplastic pavement stripping material conforming to AASHTO M249 that is applied to the road surface in a molten state by mechanical means with surface application of glass beads at a rate of not less than 350 g/L of glass beads having a size range of drop-in type and will produce an adherent reflectorized stripe of specified thickness and width capable of resisting deformation by traffic.

612.2 Material Requirements

1. Reflectorized Thermoplastic Pavement Material shall be homogeneously composed of pigment, filler, resins and glass reflectorizing spheres.

- 2. Glass Beads (Pre-Mix) shall be uncoated and shall comply with the following requirements:

Refractive Index, min. - 1.50
 Spheres, Percent, min. - 90

Gradation:

Sieve, mm	Mass Percent Passing
0.850	100
0.600	75-95
0.425	-
0.300	15-35
0.180	-
0.150	0-5

612.3 General Requirements

612.3.1 Composition

The pigment, beads and filler shall be uniformly dispersed in the resin. The material shall be free from all skins, dirt and foreign objects and shall comply with the requirements as specified in Table 612.1

Table 612.1 Composition Requirements

Components	White	Yellow
Binder, min	18.0	18.0
Glass Beads:		
Min.	30.0	30.0
Max.	40.0	40.0
Titanium Dioxide, min.	10.0	
Chrome Yellow, Medium. Min.		10.0
Calcium Carbonate And Inert Fillers, Max.	42.0	42.0

612.3.2 Qualitative

The material shall conform to the qualitative requirements as specified in Table 612.2

Table 612.2- Qualitative Requirements

Property	Requirements	
	White	Yellow
Specific Gravity, max	2.15	
Drying Time, minutes, max	10.00	
Bond Strength to Portland Cement Concrete after heating for four (4) hours ± min. @ 218 °C, Mpa, max	1.24	
Cracking Resistance@ low temp. after heating for four (4) hours ±5min. @218±2°C	No Cracks	
Impact Resistance after heating for four (4) hour ±5 min. @ 218 ±2°C and forming test specim mm/Kg, min.	115.00	
Softening Point after heating for four (4) hours ±5 min. @ 218 ±2°C.	102.5 ± 9.5 °C	
Daylight reflectant @ 45 Degrees – 0 degree, & min.	75.00	45.00

612.4 Application Properties

The material shall readily extrude at a temperature of 211 ± 7°C, from approved equipment to produce a line 3.2 to 4.8 mm thick, which shall be continuous and uniform in shape having clear and sharp dimensions.

The material shall not exude fumes which, are toxic, obnoxious or injurious to persons or property when heated during applications.

The application of additional glass beads by drop-in method shall be at a rate of not less than 350g/L of glass beads having a size range for drop-in type. The Typical size range of spheres of drop-in type paints is as follows;

Passing 850 um (#20) sieve and retained on 250 um (#60) sieve, %	80 – 100
---	----------

a) Preparation of Road Surface

The materials should be applied only on the surface which is clean and dry. It shall not be laid into loose detritus, mud or similar extraneous matter, or over an old paint marking, or over an old thermoplastic marking which is faulty. In the case of smooth, polished surface stones such as smooth concrete, old asphalt surfacing with smooth polished surface stones and/or where the method of application of the manufacturer of the thermoplastic materials shall be recommended the application of materials shall be with the approval of the Engineer.

b) Preparation of Thermoplastic Materials

The materials shall be melted in accordance with the manufacturer’s instruction in a heater fitted with a mechanical stirrer to give a smooth consistency to the thermoplastic and such that the local overheating shall be avoided. The temperature of the mass shall be within the range specified by the manufacturer and shall on no account be allowed to exceed the maximum temperature stated by the manufacturer. The molten material shall be used as expeditiously as

possible and for thermoplastics which have natural resin binders or otherwise sensitive to prolong heating the materials shall not be maintained in a molten condition for more than 4 hours.

c) Laying

Center lines, lane lines and edges shall be applied by approved mechanical means and shall be laid to regular alignment. Other markings may be applied by hand-screed, hand propelled machine or by self-propelled machine approved or directed by the Engineer. After transfer to the laying apparatus the materials shall be maintained within the temperature range specified by the manufacturer and stirred to maintain the right consistency for laying.

In the case of screen application the material shall be laid to a thickness of not less than 3mm (approx. 1/8 inch) or more than 6mm (1/4 inch) unless specifically authorized by the Engineer when laid over an existing marking. In the case of sprayed application the material shall be laid to the thickness of not less than 1.5 mm unless specifically authorized by the Engineer. In all cases the surface produced shall be uniform and appreciably free from bubbles and streaks. Where the Contract Documents require or the Engineer directs that balloting shall be applied to the surface of the markings, these shall be applied uniformly to the surface of hot thermoplastic immediately after laying such that the quality of ballotini firmly embedded and retained in the surface after completion complies with the requirements of Subsection 606.2.2 Materials Requirements.

Road markings of a repetitive nature, other center lines, lane lines, etc. shall unless otherwise directed by the Engineer be set out with stencils which comply with the size and spacing requirements shown on the Drawings.

d) Re-use of Thermoplastic Materials

At the end of the day as much as possible, the remaining material in the heater and/or laying apparatus shall be removed. This may be broken and used again provided that the maximum heating temperature has not been exceeded and such re-using of material shall be approved by the Engineer.

612.4.1 Defective Materials or Workmanship

Materials which are defective shall be replaced by a new one, to the satisfaction and approval of the Engineer. If in case pavement marking has been applied in an unsatisfactory manner or in incorrect dimensions or in a wrong location, it shall be removed immediately and shall be corrected by the Contractor at his own expense. The road pavement shall be made good to the satisfaction and approval of the Engineer.

612.4.2 Protection of the Traffic

The Contractor shall protect pedestrians, vehicles and other traffic adjacent to the working area against damage or disfigurement by construction equipment, tools and materials or by spatters, splashes and smirches or paint or other construction materials and during the course of the work, provide and maintain adequate signs and signals for the warning and guidance of traffic.

612.5 Sampling

A minimum weight of 10 kg. of Reflectorized Thermoplastic paint shall be taken for every 100 bags or fraction thereof.

612.6 Testing

The material shall be tested in accordance with AASHTO T 250 or with the appropriate method in ASTM designation.

612.7 Packing and Marking

The material shall be packaged in a suitable containers to which it will not adhere during shipment and storage. The blocks of cast thermoplastic material shall be approximately 300 x 915 by 51 mm and shall weigh approximately 23 kg. Each container label shall designate the color, manufacturer's name, batch number and date of manufacture. Each batch manufactured shall have its own separate number. The label shall warn the user that the material shall be heated to $211 \pm 7^{\circ}\text{C}$ during application.

612.8 Method of Measurement

The quantity of pavement markings to be paid for shall be the area in square meter as shown on the Drawings of symbols, lettering, hatching and the like, as completed and accepted.

The quantity shown in the Bill of Quantities represents the approximate quantity in square meter of pavement markings, with width as shown and applied at the centerline of the road pavements to which may be increased or decreased depending on the Engineer's decision whether to require additional markings or delete parts of it. Other markings representing symbols, lettering, hatching and others in locations where they maybe required by the Engineer shall, likewise, be implemented by the Contractor using reflectorized thermoplastic pavement markings as approved and directed.

612.9 Basis of Payment

The quantities measured as determined in section 612.8, Method of Measurement, shall be paid for at the appropriate contract unit price for the Pay Items shown in the Bill of Quantities which price and payment shall constitute full compensation for furnishing and placing all materials, sampling and packing, for the preparation of the surface, and for all labor, equipment, tools and incidentals necessary to complete the Item.

Payment will be made under:

Pay Item Number	Description	Unit of Measurement
612(1)	Reflectorized Thermoplastic Pavement Markings (White) 3.20mm thick	Square Meter

ITEM 613 CONCRETE JOINT SEALANT (HOT-POURED ELASTIC TYPE)**613.1 Description**

This item shall consist of furnishing and placing joint sealant, composed of a mixture of materials that will form a resilient and adhesive compound capable of effectively sealing joints and cracks applied either hot or cold in concrete pavements, bridges and other structures, in accordance with the Specification and to the details shown on the Plans, or as directed by the Engineer.

This specification applies to the following types of concrete joint sealant:

- a. Concrete Joint Sealant Hot-Poured Elastic Type
- b. Concrete Joint Sealant Cold-applied Type

613.2 Materials Requirements**613.2.1 Sealing Compound**

Concrete joint sealant materials shall be homogeneously composed of one substance, or of two or more substances that are to be mixed prior to application. The substance shall be of such a character that a homogeneous preparation can readily be obtained by mechanical or manual stirring without heating the blended material above a temperature of 38°C. The sealing compound, after curing, shall be a resilient and adhesive material that is capable of sealing joints in concrete.

613.2.2 General Requirements

The concrete joint sealant shall be capable of sealing joints and/or cracks against the infiltration of moisture and foreign materials throughout repeated cycles of expansion and contraction with temperature changes, and that will not flow from the joint/crack or be picked-up by vehicle tires on pavement at summer temperature.

The concrete joint sealant shall be capable at being brought to a uniform application consistency suitable for completely filling the joints without inclusion of large air holes or discontinuities and without damage to the material.

The sealing compound, after curing, shall be of such nature that it will adhere to dry but dust-free concrete or to damp concrete free from surface moisture.

613.2.3 Backer Material

Backer material when used shall conform to ASTM D 5249.

Backer material or bond breaker in the bottom of the joint to be filled with concrete joint sealer shall be used to control the depth of sealant and achieve the desired shape factor, and to support the sealant against indentation and sag. Backer materials shall be compatible with the concrete joint sealer. It shall be compressible without extruding the concrete, and shall recover to maintain contact with the joint faces when the joint is open.

613.3 Construction Requirements

613.3.1 Equipment

For installation of the joint sealer, hot-poured elastic type, all equipment necessary for the satisfactory performance of this construction shall be on the project site and approved by the Engineer before work will be permitted to begin.

613.3.2 Joints Preparation

Pavement joints in new construction for application of concrete joint sealer shall be dry, clean of all scale, dirt, dust, curing compound, and other foreign matter. The sidewalls of the joint space to be sealed shall be thoroughly cleaned, blown free of loose sand by high-pressure air.

For maintenance or resealing of joint that have previously contained either similar or dissimilar sealing material, the joint shall be dry, cleaned thoroughly with a plow, router, wire brush, concrete saw, or other suitable tools designed for the purpose of neatly cleaning pavement joints. Loose material shall be blown free of loose sand with high-pressure air.

613.3.3 Heating

The concrete joint sealer shall be heated within the manufacturer's specified application temperature range, in a kettle or melter, constructed as a double boiler, with the space between the inner and outer shells filled with oil or other heat transfer medium. Positive temperature control, mechanical agitation, and recirculating pumps shall be provided. The Engineer shall approve other methods of indirect heating. Direct heating shall not be used.

The manufacturer shall certify that the material is capable of being reheated satisfactorily at least once and specifically designate any limits to the number of reheating times for the material.

613.3.4 Application

Concrete joint sealer shall be applied to joint using a melter-applicator. Joints shall be filled in a neat workmanlike manner from flush to 5mm below the adjacent pavement surface.

The joint sealer shall be protected from traffic until it is fully cured.

Restriction on joint width and pavement temperature at the time of joint sealer application shall be shown on the Plans. In the absence of temperature range, applications above 32°C shall not be permitted.

613.4 Delivery and Storage

Joint sealer shall be delivered in manufacturer's original unopened containers and packaging, with labels clearly identifying product name and manufacturer. The joint sealer shall be stored in dry and shaded area in accordance with manufacturer's instructions. Containers shall be sealed until it is ready for use. Expired joint sealer shall be removed from the site.

613.5 Sampling and Testing

Sampling shall be taken at the plant or warehouse prior to delivery or at the time of delivery. If sampling is done prior to shipment, the Engineer shall have the access to the materials to be sampled. The Engineer shall be provided all reasonable facilities for inspection and sampling shall be conducted so as not to interfere unnecessarily with the operation of the works.

Sample shall consist of one of the manufacturer’s original sealed containers selected at random from the lot or batch of finished material that was manufactured simultaneously or continuously, as a unit between the time of compounding and the time of packaging or placing in shipping containers.

Obtain the hot-poured type sealant portion for testing from the selected manufacturer’s original sealed container in accordance with ASTM D 5167. The sample portion added to and heated in the melter shall weigh 800 ± 50 g.

Heat the material in accordance with ASTM D 5167

Testing for hot-poured type sealant shall be in accordance with ASTM D 5329.

613.6 Method of Measurement

The quantity to be measured and paid for will be the number of kilogram of any joint sealant applied in the accepted pavement or structure.

613.7 Basis of Payment

The accepted quantity measured as prescribed in Section 613.6, Method of Measurement shall be paid for at the contract unit price of the joint sealant, which price and payment shall be full compensation for furnishing and placing all materials, including all labor, equipment, tools and incidentals necessary to complete this Item.

Payment will be made under:

Pay Item Number	Description	Unit of Measurement
613 (1)	Concrete Joint Sealant (Hot Poured Elastic Type)	Kilogram

ITEM 618 REFLECTORIZED THERMOPLASTIC RUMBLE STRIPS

618.1 Description

This Item shall consist of furnishing and applying reflectORIZED thermoplastic rumble strips on the surface of the pavement in accordance with this Specification and at the locations shown on the Plans, or required by the Engineer.

618.2 Material Requirements

618.2.1 ReflectORIZED Thermoplastic Pavement Material and Glass Beads (Pre-Mix)

Both materials shall conform to their respective requirements of Section 612.2, Materials Requirements, Item 612 – Reflective Thermoplastic Pavement Marking.

618.3 General Requirements

618.3.1 Design

618.3.1.1 General

Reflectorized thermoplastic rumble strips shall have the following dimension:

Height	:	4.0 mm to 13 mm
Width	:	50 mm to 100 mm
Spacing	:	200 mm to 500 mm

As much as possible, placement of reflectorized thermoplastic rumble strips shall be limited to rural locations and shall not be installed near residential areas because of the noise it can generate. It should not be placed through pedestrian crossings or on bicycle routes.

The recommended length of road section where reflectorized thermoplastic rumble strips are to be installed shall be from 20 m to 30 m depending on the advisory speed limit of the road section.

The color of reflectorized thermoplastic rumble strips shall be either white or yellow.

Reflectorized thermoplastic rumble strips placed in the travelled way should not be overused. If used at too many locations, reflectorized thermoplastic rumble strips may lose their ability to gain the motorist's attention.

618.3.1.2 Pattern

The Contractor shall lay out a reflectorized thermoplastic rumble strips test pattern prior to the start of construction for approval by the Engineer. Pattern shall be balanced to provide adequate warning to drivers without being so severe that they state drives or upset motorcycles.

The pattern of reflectorized thermoplastic rumble strips shall finish within 50 m of any hazard it is associated with.

618.3.1.3 Composition

It shall conform to the requirements of Subsection 612.3.2, Composition, Item 612 – Reflective Thermoplastic Stripping Materials (Solid Form).

618.3.1.4 Qualitative

It shall conform to the requirements of Subsection 618.3.3, Qualitative,

Item 612 – Reflective Thermoplastic Stripping Materials (Solid Form).

618.4 Application Properties

It shall conform to the requirements of Subsection 618.4, Application Properties, Item 612 – Reflective Thermoplastic Stripping Materials (Solid Form).

Reflectorized thermoplastic rumble strips shall be placed transverse to motor vehicle traffic movement. It shall not adversely affect overall pavement skid resistance under wet or dry conditions and shall not be placed on sharp horizontal or vertical curves. It shall be applied over deteriorating existing reflectorized thermoplastic rumble strips or pavement surface.

A sign warning the drivers of the onset of reflectorized thermoplastic rumble strips may be placed in advanced of rumble strips installation.

618.5 Sampling

It shall conform to the requirements of Section 618.5, Sampling Item 612 – Reflective Thermoplastic Stripping Materials (Solid Form).

618.6 Testing

It shall conform to the requirements of Section 618.6, Testing, Item 612 – Reflective Thermoplastic Stripping Materials (Solid Form).

618.7 Packing and Marking

It shall conform to the requirements of Section 618.7, Packing and Marking, Item 612 – Reflective Thermoplastic Stripping Materials (Solid Form).

618.8 Method of Measurement

The area to be paid for under this Item shall be the number of square meter (m²) of reflectorized thermoplastic rumble strips applied and accepted.

618.9 Basis Payment

Payment shall constitute full compensation for furnishing and application of reflectorized thermoplastic rumble strips including all labor, equipment, tools and incidentals necessary to complete the Item.

Payment will be made under:

Pay Item Number	Description	Unit of Measurement
618(1)	Reflectorized Thermoplastic Rumble Strips (White) 6.0mm thick	Square meter

ITEM 622 BIO-ENGINEERING SOLUTIONS (COCONET)

622.1 Description

This Item cover installation of cocnut coir fiber made into geonets such as coconets, coco-logs, coco twines and coco peat as bioengineering materials for controlling soil erosion and slope stabilization in accordance with the cross section shown on the Plans or as directed by the Engineer.

622.2 Material Requirements

622.2.1 Coconut Coir

Coconut coir fiber materials for use in the fabrication of cocnut geonets shall be a multi-cellular fiber with 12 to 24 microns in diameter and the ratio of the length to diameter shall be 35. The fiber shall also be hygroscopic, with moisture content of 10% to 12% at 65% humidity and 22% to 55% at 95%relative humidity.

622.2.2 Coco-net and Coco-log/Fascine

Coco-net and Coco-log shall conform to the Table 1 and Table 2 respectively.

Table 1- Physical Properties of Coco-net

Property		Coconet 400	Coconet 700	Coconet 900
Thicknes,mm Width,m Length,m		10.0 Min 1.0Min. 25.0Min.		
Unit Weight 1g.m2		400±20	700±35	900±45
Diameter of Twine,mm Hand and Machine Spuns		5.0 mm ± 0.50 mm		
No of Twines/m (Hand&Machine) Spuns	Crosswise Direction	40 Min	40 Min	70 Min
	Lenghtwise Direction	40 Min	70 Min	70 Min

Table 2 Physical Properties of Coco- log

Type of Coco-log/Fascine	Diameter (mm)	Weight (min.) (Kg/m)
Cocolog 100	100	2.0
Cocolog 200	200	4.5
Cocolog 300	300	10
Cocolog 400	400	20
Cocolog 500	500	30

622.2.3 Backfill

Backfill shall be in accordance with the approved Plan and shall conform to the requirements of Item 104-Embankment.

622.2.4 Bamboo Stakes

Bamboo stakes shall be mature and shall be 30 to 40mm in width and 300 mm long.

622.3 Construction Requirements**622.3.1 Quality Control**

The coconut geonets manufacturer shall be responsible for establishing and maintaining a quality control program to assure compliance with the requirements.

622.3.2 Equipment

Equipment and tools necessary for handling materials and performing all parts of the works shall be approved by the Engineer as to design, capacity and mechanical condition. The equipment shall be at the jobsite sufficiently ahead of the start of construction operations.

622.3.3 Site Measurement

Site measurement shall be done to prepare specific lengths of the coco-nets to conform the necessary area requirements and the necessary length for coco-logs to be installed/placed.

622.3.4 Preparation of Beds

Site for net installation shall be graded and sloped to the approved shall be design and any runoff control such as diversions, dikes and berms shall be completed prior to installation. All depression/gullies and eroded portions shall be backfilled for the coco-nets to snugly come in contact with the soil surface. The face of the slope shall be smoothed. Rocks, clods, vegetation (deemed detrimental to the erosion control system to be installed), and other obstructions shall be removed from the tip to the toe of the slope to ensure complete contact to the coco-nets with the soil.

622.4 Method of Measurement

The area to be paid for under this Item shall be the number of square meter (m²) of coco-net, linear meter for coco-log, square meter of live vetiver grass hedgerow and square meter of effective vegetative growth of grass cover, installed/placed and accepted into the completed project.

622.5 Basis Payment

Payment shall constitute full compensation for the accepted quantities prescribed in Subsection 622.4 Method of Measurement and shall be paid for at the contract unit price for the coconut geonets, which price and payment shall be for the preparation of bed and furnishing of all materials for placing/installation of coconut geonets and furnishing of all labor, maintenance of plants, equipment, tools and incidentals necessary to complete the Item.

Payment will be made under:

Pay Item Number	Description	Unit of Measurement
622 (1)a	Bio-Engineering Solutions (Coco-net 700CGN)	Square meter
622 (3)a	Bio-Engineering Solutions (Vegetation Grass-Cover)	Square meter

ITEM SPL 1200-1 BIKEWAY PAVING (Reinforced Concrete with Exposed *Glow in the Dark Aggregates* Finished)

1.0 Description

This Item shall consist of the construction of portland cement concrete bikeway in accordance with this Specification and to the lines, grades, levels and dimensions shown on the Plans, or as required by the Engineer.

2.0 Material Requirements

2.1 Portland Cement Concrete

The cement concrete shall be Class A as specified in Item 405, Structural Concrete.

2.2 Glow In the Dark Aggregates

Glow in the Dark Aggregate material shall be use for this bikeway lane.

2.3 Reinforcing Bars

All reinforcing bars must conform to the requirement of Item 404- Reinforcing Steel.

2.4 Expansion Joint Filler

Unless otherwise ordered, the preformed joint filler shall have a thickness of 5 mm and shall conform to the conform to the requirements of Item 311, Portland Cement Concrete Pavement.

2.5 Forms

Forms shall be of wood or metal as approved by the Engineer and shall extend to the full depth of the concrete. All forms shall be straight, free from warps and of adequate strength to resist distortion.

2.6 Bed Course Material

Bed course material consists of cinders, sand, slag, gravel, crushed stone or other approved permeable granular material of such grading that all particles shall pass a 12.5 mm (1/2 inch) sieve.

3.0 Construction Requirements

Installation

- a) Forms must be made of wood, metal or plastic, and are attached to stakes to contain the concrete in the area desired. It is important that forms are in good condition, be set to provide the proper slope or grade for drainage, and should be constructed to create clean corners where they abut each other or on bridge sidewalks.

All forms shall be staked securely in position at the correct line and level. Performed joint filler shall be set in position shown on the Plans before placing of the concrete is started. The top of the joint filler shall be placed 5 mm below the top surface of the finished sidewalk.

The mixing, placing, finishing and curing of concrete shall be as specified in Item 405, Structural Concrete. The Portland cement concrete shall be placed to the total depth shown on the Plans.

The surface shall be cut through to a depth of 10 mm with a trowel at intervals of 1 m or, were required, in straight lines perpendicular to the edge of sidewalk. The surface shall then be brushed. The edges of the sidewalk and the transverse cuts shall be shaped with a suitable tool so formed as to round the edges to a radius of 15 mm.

- b) Using steel reinforcing bars or welded wire mesh is critical in providing structural function and support in the slab. The main reasons to include reinforcement in the slab is to help control cracking, provide structural capacity, increase impact resistance, and reduce joint maintenance. The most common method for placing concrete is to have the ready-mix truck pull up to the placement area and deposit the concrete from the chute. The concrete should be placed as close to its final destination as possible because moving it around too much (with shovels or other tools) can lead to segregation. Also be sure plastic sheeting is used to protect adjacent slab or other existing slabs from concrete splatter. The type of concrete used is also crucial to successful placement. Make sure to discuss with the Engineer and submit a construction methodology for approval to avoid issues on the proper slump, or mix design.
- c) Sidewalk/bikeway slabs should be monolithically poured with concrete with a design mix as follows: portland cement, 1 part by weight, three-eighths inch and smaller pea gravel, 3.2 parts by weight, and concrete sand, 2.3 parts by weight.
- d) The work done immediately following concrete placement is critical, since this is when you must create the perfect canvas for decorative stamping.

Factors to be considered are as follows;

1. The surface shall be leveled to prevent any low or high spots, and that cement paste should be brought to the surface to permit a well-defined imprint. Water should be carefully controlled to hold the slump as low as practicable for workability. In placing the concrete, usual procedures should be followed with respect to spreading and screed leveling. Following the straightedge, the slab should be wood floated

with darbles or bull floats until the surface is leveled and properly sloped to drains.

2. Toss the ½ inch diameter **glow-in-the-dark aggregates** over the entire concrete surface as it is setting up. Gently work the aggregates into the curing concrete with a trowel, leaving them just under the surface covered with a thin film of concrete. The spread of glow-in-the-dark aggregates per square meter shall be 200 grams
3. To expose the aggregates, the curing concrete surface shall be lightly sprayed by a concrete retarding agent. The concrete retarder chemically slows down the curing process leaving 1/8 to 3/8 inch of the surface uncured. The top is then pressure-washed off, which exposes the **glow-in-the-dark and the non-glow-in-the-dark aggregates** on the surface. After washing, normal curing practices should be employed.

4.0 Method of Measurement

The area to be paid for shall be the number of square meters of sidewalk/bikeway measured, completed in-place and accepted.

5.0 Basis of Payment

The quantity as determined in Subsection SPL 601()a 4.0, Method of Measurement, shall be paid for all the contract unit price per square meter for Bikeway which price and payment shall constitute full compensation for furnishing and placing all materials for bridge concrete sidewalk, glow in the dark aggregates, expansion joint material, for excavating and compacting the foundation bed, for furnishing and placing cinders, gravel or other permeable bed course material, for forms and for all labor, equipment, tools and incidentals necessary to complete the Item.

Payment will be made under:

Pay Item Number	Description	Unit of Measurement
SPL 1200-1	Bikeway Paving , (75mm thick Reinforced Concrete with Exposed Glow in the Dark Aggregates Finished)	Square Meter

PART K

STREET LANDSCAPE

PART K - LANDSCAPE**SPL 1200 – STREET LANDSCAPE****7.1 Scope of Work**

This section includes the furnishing of all plant, tools, equipment, materials and other in the installation of waterproofing and roofing, including miscellaneous sheet metal works as required providing a waterproof installation.

7.2 Hardscape Components**7.2.1 Concrete Reinforcement*****Product Delivery, Storage and Handling***

All reinforcing bars delivered to the site shall be new and shall be carefully stored and sheltered to prevent from rust, oil defects, grease per kinks.

Materials

- a. Deformed Reinforcing bar: ASTM A G15 M-82
- b. G.I Wire Ga. No.16 - shall be used for tying bar intersections
- c. Reinforcing bars specified by structural engineer's drawings for landscape area

Preparatory Works

Bends for stirrups and ties shall be made around a pin having diameter not less than two times the minimum thickness of the bar. Bends for other bars shall be made around a pin having a diameter not less than six times the minimum thickness of the bar, except for bar larger than 1- inch, the pin shall not less than eight times the minimum thickness of bar. All bars shall be bent cold. Heating of reinforcement will not be permitted and reinforcement shall not be bent or straightened in any manner that will injure the material.

Installation

- a) Metal reinforcement shall be accurately placed in accordance with the plans and shall be secured in position by concrete or metal chairs or spacers. Nails shall not be driven into forms to support reinforcement nor shall tie wires come in contact with forms. All steel reinforcement shall be accurately placed against displacement by tying them together at each bar intersection with Ga. No. 16 G.I. wire
- b) Design: Laps and splices shall be sufficient to transfer stress between bars by bond and shares. Splices generally shall be avoided at points of maximum shear in every member. Bar extension of cut-off reinforcing bars shall be 12 times bar diameter of the effective depth, whichever is greater.

Concrete Protection

Unless otherwise noted, the thickness of concrete over reinforcement shall be as follows:

- a. Where concrete is deposited against ground without use of forms, not less than 75mm.
- b. Where concrete maybe exposed to ground but placed on forms not less than 50mm.
- c. Where concrete maybe exposed to weather, not less than 50mm.
- d. In all cases, the thickness of concrete over the reinforcement shall be at least equal to the diameter of round bars or one and one half times the side dimensions of square bars.

Do not allow pedestrian traffic on the newly installed reinforcement to prevent misalignment of bars.

Cleaning

Upon installation of reinforcing bars is completed, surplus, materials, apparatus, etc. shall be removed and shall be left in a clean and neat condition ready for concreting.

7.2.2 Stone and Other Finishes

7.2.2.a Textured Homogenous Tiles on Concrete Slab

Preparation

- a) Structural slabs with limited bending: Prepared in accordance with ANSIA108.1. Before stones are applied with dry set mortar, the structural concrete floor shall be tested for levelness or uniformity of slope by using a straight edge. Areas where the floor does not meet the required tolerances shall be filled and leveled in accordance with ANSI A108.5 and provide expansion joints.
- b) Slab on Grade construction where no bending stresses occur: Prepare in accordance with ANSI A108.1.
- c) The concrete surface shall be wet for at least four (4) hours before the scratch coat is applied. The required scratch coat of cement mortar is the proportion of one (1) part Portland cement to two (2) parts sand, by volume shall be applied to not more than $\frac{3}{4}$ in thickness.

Installation

- a) The buttering mortar for tiles shall be per manufacturer specifications and shall be worked to true even plain, either leveled or sloped to drain as required. For areas of more than 100 sq. ft. screed strip shall be set as temporary guide to secure this result. As large a floor area as can be covered with tiles before the mortar has reached its initial set, shall be placed in one operation. When more setting mortar has been spread then it can thus be covered, it shall be cut to a clean beveled edge close to the tiles and be removed.
- b) Tiles shall be firmly secured in place. Joints shall be well-filled, lines kept straight and true, and finished surfaces brought to a true plane. The complete work shall be free from loose, cracked or broken units.

Grouting

Grouting shall be done as soon as the mortar beds have sufficiently settled. Cement grout shall be colored as called for by the color of the tiles.

Protection

Spaces in which tiles are being laid shall be closed to traffic or other work shall be kept free until the floors are completed and the stones firmly set. Tile work shall be adequately protected from damage until the completion of the contract.

Cleaning

Upon completion of the work, wash the finished surface with clean water and brush thoroughly to produce a clean and sparkling appearance.

7.2.2.b Exposed Aggregate Finish with Glow-in-the-Dark Aggregates

Installation

- a) Forms, made from wood, metal or plastic, are attached to stakes to contain the concrete in the area desired. It is important that forms are in good condition, be set to provide the proper slope or grade for drainage, and are erected to create clean corners where they abut each other or structures.
- b) Using steel reinforcing bars or welded wire mesh is critical to providing structural function and support in the slab. The main reasons to include reinforcement in the slab is to help control cracking, provide structural capacity, increase impact resistance, and reduce joint maintenance. The most common method for placing concrete is to have the ready-mix truck pull up to the placement area and deposit the concrete from the chute. The concrete should be placed as close to its final destination as possible because moving it around too much (with shovels or other tools) can lead to segregation. Also be sure plastic sheeting is used to protect adjacent buildings, landscaping, or other existing slabs from concrete splatter. The type of concrete used is also crucial to successful placement. Make sure to discuss with your contractor how he plans to avoid issues that can arise without the proper slump, or mix design.
- c) Slabs should be cast monolithically with a mix as follows: portland cement, 1 part by weight, three-eighths inch and smaller pea gravel, 3.2 parts by weight, and concrete sand, 2.3 parts by weight.
- d) The work done immediately following concrete placement is critical, since this is when you must create the perfect canvas for decorative stamping. The two most important factors are that the surface is leveled to prevent any low or high spots, and that cement paste is brought to the surface to permit a well-defined imprint. Water should be carefully controlled to hold the slump as low as practicable for workability. In placing the concrete, usual procedures should be followed with respect to spreading and screed leveling. Following the straightedge, the slab should be wood floated with darbles or bull floats until the surface is level and properly sloped to drains.
- e) Toss the ½ inch diameter glow-in-the-dark aggregates over the entire concrete surface as it is setting up. Gently work the aggregates into the curing concrete with a trowel, leaving them just under the surface covered with a thin film of concrete. The spread of glow-in-the-dark aggregates per square meter shall be 200 grams

- f) To expose the aggregates, the curing concrete surface shall be lightly sprayed by a concrete retarding agent. The concrete retarder chemically slows down the curing process leaving 1/8 to 3/8 inch of the surface uncured. The top is then pressure-washed off, which exposes the glow-in-the-dark and the non-glow-in-the-dark aggregates on the surface. After washing, normal curing practices should be employed.

7.2.2.c Groove Line Finish

The concrete shall be screed and floated to the required finish level with no coarse aggregate visible while concrete is still green, steel or wood trowel to an even, smooth finish and then a fiber bristle brush in a direction transverse to that of the main traffic. This should be used on sidewalks in plain cement finish.

7.2.2.d Concrete Pavers on Sand Setting

Paving Material

0.125m x 0.368m x 0.05m Plank Paver, Dark Gray, 3000 psi minimum by Quality-Star Concrete Products, Inc. or approved equivalent

Sand Setting Bed Material

Sand shall generally referred to as sand setting and shall free of organic materials and any other contaminates that could potentially stain or otherwise damage the unit pavers.

Edge Restraint

Paving banding materials as indicated in landscape architectural drawings.

Execution

Examine all surfaces to receive the parts of the work specified. Contractor shall verify all dimensions of in-place and subsequent construction. Contractor shall not proceed with the work until unsatisfactory conditions have been corrected. Installation of concrete pavers and associated construction constitutes acceptance of the adjacent and underlying construction.

Installation of Sand Setting Bed

- a) (Optional) Place a layer of the specified geotextile filter fabric uniformly on the surface of the properly prepared grade that is ready to receive the sand setting bed. Cover the designated area in its entirety.
- b) Place solid steel $\frac{3}{4}$ or 1 inch thick control bars directly on the sand or geotextile filter fabric. Install shims under bars for minor adjustment of depth and finish paver elevations and slopes. Space bars approximately 7 feet apart and parallel to each other to serve as guides for strike-off boards. Spacing can vary as determined by the size of the area and layout.
- c) Place sand setting bed between control bars on the sand or geotextile filter fabric to not less than thickness of the designated control bars. Spread material and strike off by pulling the material with a 8 foot long x 2

inch x 6 inch wood board several times to produce a smooth firm and even setting bed. Add fresh material in low areas after each pass of the strike-off board. After each panel is complete remove and advance the first control bar to the next panel position in readiness for placing and striking adjacent panels. Fill in depressions left by the control bar and any shims.

Paver Installation

- a) Install concrete pavers, slabs and curbs in locations, patterns and at elevations and with slopes for surface drainage as shown on the Drawings. Install concrete pavers, slabs and curbs in accordance with the manufacturer's printed installation instructions and the final reviewed shop drawings.
- b) Lay out pavement in working area modules according to concrete paver mainfield as specified in landscape architectural drawings. Set concrete pavers, slabs and curbs by hand, on sand setting bed in patterns shown on the drawings with hand tight joints 1/8 to 3/16 inch wide joints and uniform top surfaces.
- c) Field cut concrete pavers in accordance with manufacturer's recommendations for methods, equipment and precautions.
- d) Maintain accurate alignment and check for creep and shrinkage. Make adjustments to creep and shrinkage within the concrete paver working area or mainfield.
- e) Install edge restraints where required and as shown on landscape architectural drawings and details.
- f) Spread sand to fill joints immediately after installing concrete pavers on setting bed. Brush in sand until joints are completely filled, remove surplus sand. Do not allow traffic on installed pavers, slabs or curbing until the joints have been filled.
- g) Protect newly laid pavers with plywood panels on which workers stand. Advance protective panels as work progresses but maintain protection in areas subject to continued movement of materials and equipment to avoid creating depressions or disrupting alignment of installed pavers.
- h) Contractor to replace cracked or chipped concrete pavers until final acceptance period by Owner.

Cleaning and Protection (Responsibility of end user)

- a) Remove and replace pavers, which are loose, chipped, broken, stained or otherwise damaged or if units do not match adjoining units as intended. Provide new units to match adjoining units and install in same manner as original units with same joint treatment to eliminate evidence of replacement
- b) Cleaning: Remove soiling from exposed paver surfaces and brush of particles aside from sand.

- c) Provide final protection and maintain conditions in a manner acceptable to installer, which ensures paver work being without damage or deterioration at time of substantial completion.
- d) Spread sand to backfill the spaces along the edges of the concrete paver mainfield and level concrete pavers to specified finish floor elevation as per landscape architecture drawings.

7.2.3 Metal Works

Materials

- a) All metals shall be free from defects impairing strength, durability or appearance and shall be of best commercial quality for each intended purpose.
- b) Fastening: Which are exposed shall be of the same material, color and finish as the metal to which they are applied, unless otherwise shown on the drawings or as specified. All items employed with galvanized iron and steel shall be galvanized ferrous metal.
- c) Steel Shapes: Shall conform to the requirements of ASTM A36 for the Structural Steel. Steel Pipes shall conform to ASTM A53 or A120.
- d) Cast Iron: Shall conform to the requirements of ASTM A36 for the structural Steel. Steel pipes shall conform to ASTM A53 or A120.
- e) Gauges: Of sheet iron and steel are U.S. Standard for sheet and plate where needed. Gauges of non-ferrous metals are Brown and Matte.

Installation

- a) Take all measurements required at the building. Check and compare dimensions and other data with various trades, installing adjoining work to assure proper coordination.
- b) Do all drilling and fitting, cutting, welding, bolting and riveting required to erect, install and fit metal work to adjoining work. Conform to AISC Code. Furnish all screws, bolts, anchors, etc., required to attach metal work securely to adjoining work.
- c) Do not cut or alter members in the field without Landscape Architect's approval or Engineer's approval. Do not enlarge unfair holes by burning or forcing, but correct by reaming.
- d) Be responsible for the correct location of miscellaneous metal work, including anchor bolts and base plates, lintels and others. Take particular care to details.
- e) All work should be accurately set to established lines and elevations and rigidly fastened in place with suitable attachments to the construction of the building.
- f) Furnish, fabricate, install and anchor all lights steel, miscellaneous and ornamental metal/grille work as indicated in the drawings as specified

herein. Install all supports and anchors for miscellaneous metal work, except those to be cast into concrete or built into masonry.

- g) Furnish all metal inserts, dovetail anchor slots, anchors, anchor bolts, fastenings, etc. for a attachment of work of all trades to concrete and masonry, except where otherwise specified or obviously included under other Section of the Specifications.

7.3 Softscape Components

7.3.1 Scope of Works

The scope of work in this section shall include but not be limited to the following:

- a. Installation of plants
- b. Removal and transfer of existing trees
- c. Maintenance of landscape area

7.3.2 Quality of Workmanship and Materials

- a. All materials and workmanship shall be of the highest standards and quality demanded by this specification. Substandard work and materials identified by the Installer's cost.
- b. All plant materials shall be of the genus, species and variety specified and substitutions shall not be permitted unless authorized in writing by the Landscape Architect.
- c. All trees and shrubs installed by the Plant Installer shall be free of pest, disease, discoloration and damage. Plants shall be well branched with vigorous shoots. The root systems of each plant shall contain a good proportion of fibrous roots.
- d. All materials are to be approved by the Landscape Architect or by the Engineer prior to use on site. Materials shall be obtained from approved sources, manufacturers and/or suppliers.
- e. Where particular products are specified and the Plant Installer wishes the use of similar products from other suppliers, prior confirmation in writing shall be obtained from the Landscape Architect or the Engineer.

7.3.3 Supply of Softscape Materials

- a) The Landscape Architect reserves the right to make field adjustments and reasonable substitutions to ensure implementation of the landscape concept in relation to field conditions.
- b) The Plant Installer (from the Contractor side) shall submit his proposed construction program based on the criteria of the Master Program showing the intended sequences, stages, and order of proceeding with the works together with the period of time he has estimated for each and every stage of progress.
- c) The Plant Installer shall liaise with other Contractors at each phase to program and execute the works.

- d) The Plant Installer shall complete the works on or before the date of completion as set forth in the Contract.
- e) All work carried out must be done in accordance with the relevant Code of Practice as stipulated by the relevant Government and Statutory bodies.
- f) The Plant Installer shall undertake all responsibility for defects and maintenance to the landscape for a period of twelve (12) months from the date of practical completion.
- g) This specification is a set of directions for the installation of Softscape Works. The Plant Installer must read these specifications at the time of tender in order to be aware of his obligations under the Contract should he be the successful bidder.
- h) It is essential therefore that the Plant Installer is fully conversant with the techniques set out in this specification and is adequately prepared with the trained management, supervisors, foreman and labor force as well as tools, equipment and materials to complete the works to the specifications.
- i) The Plant Installer shall not use different techniques or quality criteria or materials unless the alternative system has been approved in writing by the Landscape Architect or the Engineer. No cost increased for alternative specifications will be entertained unless formally submitted in writing as an improvement in the quality of a product and accepted in writing following the Client's/Owner's approval, through the Landscape Architect.
- j) The Plant Installer is to study the drawings at the time of tender and notify the Landscape Architect of any discrepancy at the time of tender submission.
- k) On completion of the works, the Plant Installer will prepare a set of as-built drawings covering the areas installed. These drawings shall be at the same scale as the original planting plans and shall contain the accurate positions of all planting with the actual number of plants installed. These drawings and the quantities shall be approved by the Landscape Architect before being signed and stamped by the Plant Installer.
- l) The general description of the works mentioned above is only for the guidance of the Plant Installer (Contractor's side) and any error or omission shall not constitute a ground for claim by the Plant Installer. The onus for investigating and ensuring the actual extent and nature of the works comprised in this Contract prior to the submission of the tender is solely with the Plant Installer. Any doubts should be clarified with the Landscape Architect before the tender is submitted. No claim arising out of lack of clarity or availability of information will be entertained. Allowance for any or all of these provisions shall be made in the tender.

7.3.4 Backfill and Growing Media

Materials for backfilling and planting holes and beds shall consist of approved quality topsoil transplanted to the site and thoroughly mixed with sand, organic compost and coco peat. The Plant Installer must submit samples for approval of Landscape Architect.

The soilmix compositions are as follows or other growing mix as specified by Landscape Architect:

Planting on Grade

Loamy topsoil	50%
White washed sand	10%
Soil Conditioner	10%
Sugarcane waste soil	6%
Rice hull	6%
fiber	6%
6% Sugarcane waste soil	6%
Rice hull	6%
6% Begasse	6%

Planter Boxes on concrete slab decks

Loamy topsoil	30%
White washed sand	10%
Soil Conditioner	7.5%
Vermiculite	7.5%
Perlite	16%
Coconut fiber	5%
Begasse	6%
Chicken manure (composted)	6%
Coconut fiber	6%
Chicken manure(composted)	6%

Soil Mix

For soil mix, submit a written statement to the Landscape Architect or Engineer by delivery, stating location of soil source and chemical analysis of soil samples including pH, percentage of soluble salts, and amount of potassium, phosphorus and nitrogen.

Mechanical Analysis of topsoil will determine conformance percentage of sand, silt, clay and organic matter.

Samples of Materials

2 soil aggregate types	-	2 liters each
2 drainage aggregate types	-	2 liters each
Soil conditioner	-	2 liters each
Filter Fabric	-	0.4 sq. m.
Mulch	-	2 kg bag
Fertilizer	-	1 liter plus manufacturer's label
Anti-Transpirant Spray	-	500 ml plus manufacturer's label

Top Soil

Soil composition for turfed areas shall be 70% sandy loam, 20% sand (washed), and 10 % organic compost (as outlined).

- a. Shall be fertile natural red/brown topsoil transported to the site, free from stones, clay, wood and sod, and obtained from naturally well-drained area. Topsoil shall neither be excessively acidic nor have high alkalinity, and shall be free from any toxic matter liable to be harmful to plant growth. The pH for topsoil shall be in the range of 5.5-6.5.
- b. Topsoil shall generally be reasonably loose in a form containing not more than 10-15% of moisture content. Topsoil delivered in a wet and soggy condition will be rejected by the Landscape Architect.
- c. Topsoil depth in designated planting areas shall be as follows:
 1. Lawns and Sodded Areas - 0.15cm
 2. Ground Cover Areas - 0.30 cm
 3. Shrubbery Areas - 0.60 cm
 4. Palms and trees - Shall conform with the size of

the root ball. Allow 0.30 minimum dimension from palm/tree root ball edge to rim of prepared excavation.

Depth of pit excavation shall have a minimum of 0.60 cm. Allow 0.30 cm soil pedestal to prevent balled tree from settling. Actual pit depth shall be determined by the existing root ball dimensions. Refer to tree planting details.

Soil Conditioner

Shall be peat moss, coco peat, ground bark, well composted chicken manure, bagasse, sugarcane (mud) waste/pulp or other approved fibrous organic matter suitable for mixing with topsoil to make a friable growing medium for plants, resistant to rapid decay, free of soluble salts below 900 ppm, pH 6-6.5, free of large lumps or debris.

Lightweight Aggregate

Shall be an approved low-density, inert material such as charcoal, expanded shale or porous volcanic stone free from dust and debris, pH 6-6.5, free of soluble salts.

Organic Compost

Shall be an organic vegetable compost e.g. tree bark compost produced by a thorough horticultural or industrial composting process. Compost is to have a clean, under composed smell free from any rotting substances, debris, refuse, clay or visible fungus. A sample and test data is to be submitted before being packed for transport and odorous materials used on site will be rejected. Any vermin resulting in use of organic compost will have to be controlled by the Plant Installer within 12 hours of any infestation.

Soil Analyst's Test Reports on Mechanical Analysis of Soil Mix

Shall be clean, coarse-grained and angular material with a minimum 1mm diameter section. It shall be well-graded, free from soluble salts ranging in size so that 80- 100% passes the 3mm sieve and 0-50% passes the 2mm sieve, with 0% passing through a 1mm sieve.

Fertilizer and Lime

- a. Fertilizer used shall be complete food having an N:P:K formulation of 15:15:15 for foliage plants and trees, and 12:12:17:2 for flowering plants.
The Plant

Installer shall also provide an approved basic fertilizer (slow release fertilizer) for every plant that is being potted and reported. The nutrients in the fertilizer must be freely available to the plants and all fertilizer must be delivered in original, unopened containers, bearing the manufacturer's guaranteed analysis.

- b. Triple Superphosphate 0-46-0 uniform in composition delivered to the site in unopened containers, each fully labeled, conforming to the applicable fertilizer laws, and bearing the name or mark of the manufacturer.

- c. Ground dolomitic limestone not less than 85% total carbonates, minimum 20% calcium and 10% magnesium. Ground so that 50% passes through the 250 microns sieve materials will be acceptable and the specified rates of application are increased proportionally on the basis of quantities passing through the 250 microns sieve.

Mulches

Coarse, ground organic materials such as coco peat, or other approved available organic matter free from soluble salts and with a pH between 5.0-7.0.

7.3.5 Plant Material

Nomenclature

Names of plants required under this contract conform to those given in Exotic Plant Manual, Alfred Byrd Graf, 3rd Edition, Roers Company, East Rutherford, N.J., USA. Names of varieties not included therein conform to names generally accepted in the nursery trade.

Quality and Size

- a. Provide plants grown in approved nursery, acclimatized not fertilized for a period of at least four months before delivery. Habit of growth that is normal for the species, sound, healthy, vigorous and free from insects, diseases, injuries, abrasions, sunscald, disfigurement. Equal to or exceeding measurements specified in branches in normal position; necessary pruning done at time of planting as recommended by the

Landscape Architect Sizes and methods of handling according to accepted practice where it is not indicated.

- b. Plants shall be grown or established in containers in which they will be delivered for at least six months but not more than twenty-four months in advance or final planting.
- c. Trees shall be well-formed with uniform branching. There shall be no abrasion of the bark, and no fresh cuts of limbs over 30 mm which have not completely callused over.
- d. Trees and palms larger in size than specified may be used but increase in price is as limited by the contract documents. It is the responsibility of the Plant Installer to ascertain that materials larger in size than that specified can be accommodated in the proposed locations.

Plants Required

The species (scientific and common name) size, manner in which to be furnished, and indication of the approximate number to complete the planting plan are given in the plant list. Plant quantities on the list are indicated only for the convenience of the Plant Installer. The Plant Installer shall furnish and plant all plant materials required by the plans. Surpluses or shortages in the list shall not be used for claims for additional compensation.

Substitution

- a. Plants of kinds other than those named in the plant list will not be accepted unless specifically approved in writing by the Landscape Architect. Proposed substitute, in each case, must possess the same essential characteristics as the type of plant actually specified in regard to appearance, ultimate height, shape, habit of growth and other requirements. Where a substitution is approved for the Plant Installer's convenience, plants of greater value may be accepted without additional cost to the Employer.
- b. The Plant Installer or his authorized representative shall be present during inspection.
- c. Make a written request to the Landscape Architect or to the Engineer, a minimum of thirty working days in advance of all inspections at the nursery. List the particular plants which are to be inspected as well as the size of the plants.

Special Guarantee

All plant materials furnished under this Section shall be guaranteed for a period of one year from Completion as to the species, hybrid, flower color and/or variety specified herein or on the drawings. If after the issue of the completion certificate for the Main Contract by the Landscape Architect, any guaranteed plant material proves to be of different species, hybrid, flower color and/or variety not initially determined, the Plant Installer shall replace that plant with a new plant of the originally specified species, hybrid, flower color and/or variety.

Minor Materials

Accessories or other materials not described but required for completed work shall conform to commonly accepted industry standards and shall be of types of sizes best suited for the intended purpose and related conditions such as using a plastic plant separator for separating lawn from shrubs and planting from grade and other purposes. The Plant Installer is required to submit samples to the Landscape Architect for approval, before installation.

7.3.6 Installation***Acclimatization***

Local practice will dictate the percent shade that should be provided during this acclimatization period. Light levels listed in the schedule of plant materials represent the approximate condition that the plant will be provided when it is installed in the building and not the light level that should be produced during the first stage of acclimatization when the plant is grown under shade before installation.

Planting

- a. Planting shall be performed in accordance with the recognized best horticultural practice.
- b. All plants must come with pots or plastic bags in which they were originally grown and established in the nursery.

- c. All plants are to be removed from their original growing receptacles prior to installation. They should be arranged in a manner such that the leaves complement each other and are within touching distance of the other and not overlapping one another unless specified to the contrary.
- d. All planting works shall have the appearance of established growth. Plants shall be arranged with their foliage showing off their best face so that the intended design will be fully realized.
- e. Plants shall be set plumb and at such a level or elevation to level surrounding ground as they bore to ground from which they were dug. All plants shall be planted on and in soil mix. The soil mix will be properly compacted before the placement of trees with a heavy root ball.
- f. Earth balled and hessian covered plants shall have all cloth, ropes, etc. removed from the tops of the earth balls but no cloth shall be pulled out from under the earth balls.
- g. In planting beds designated, deposit planting mix to full required depth as shown on the drawings. Deposit enough material to allow for settling and compaction. Compact by hand tamping and rolling. Do not compact by puddling. After soil is spread and compacted and just before planting, moisten evenly to full depth with a fine water spray. Place additional planting mix as necessary, to correct any settling occurring at this time.
- h. Bare-rooted plants are not acceptable.
- i. Disturbance to the root system or ball or earth shall be prevented in removing plants from containers. Root bound plants shall not be planted.
- j. After placing the plant, the plant pit shall be back filled with planting soil mix placed in layers and tamped firmly to eliminate air-void, minimize settlement and provide stability for the plant. A watering ring should be made out of the soil around the plant to store water.
- k. During and after planting, the plants shall be thoroughly watered to eliminate air voids around the roots and watered regularly as required for the planting to become established.
- l. All saplings shall be securely staked and tied.
- m. All semi-matured instant trees and palm shall be staked by guying or by ground anchors as specified
- n. Trees of the species and of the size specified on the plans shall be planted in locations shown. Trees shown on plans at spacing shall be accurately and evenly spaced in true lines.
- o. Shrubs shall be positioned in the location and numbers shown on plan and placed to achieve even spacing and proper matching of shapes related in a random fashion of approximately equal centers to obtain a natural dense cover.
- p. Groundcover plants and all potted plants shall be planted with a hand trowel to firm soil around roots.

7.3.7 Staking

- a. Provide all necessary support for plant material as required, such as posts and line wires for tree and tall shrub planting, stakes or tripods for tall tree sand palms, using durable materials which will remain in good condition for the duration of the contract.
- b. Stakes for supporting trees shall be sound wood, uniform in size, reasonably free of knots and capable of standing in the ground for at least one (1) year. Stakes for supporting trees, two meters tall and over shall be 50mm and not less than 2.5 meters in length.
- c. Wire for tree bracing and guying shall be pliable 12 to 14 gauge (2.0-2.8mm) galvanized soft steel wire.
- d. Ground anchors shall be 25mm diameter GI anchors or equivalent. Hose shall be two-ply fiber bearing garden hose, not less than ½” (1cm) inside diameter.
- e. Wrapping material shall be first quality, heavy waterproof crepe paper manufactured for this purpose, or first quality burlap not less than 15cm nor more than 25cm wide of suitable strength and manufactured for this purpose.

7.3.8 Maintenance Operations

- a. Watering of plants and turfed areas is the responsibility of the sub-contractor to water and spray water to remove dust to all plants regularly.

All the external plants shall be watered twice daily in the absence of sufficient natural rainfall.

- b. Weeding - all weeds found growing in the landscaped area under maintenance must be removed. All plant beds must be weeded weekly.
- c. Forking - all plant beds must be forked fortnightly to loosen the soil and provide sufficient aeration for the roots.
- d. Pruning - plant shoots must be pruned when necessary. All trees, palms, shrubs and groundcovers shall be pruned by thinning out and shortening branches to the extent of 1/3 of the existing growth. Trees shall be pruned if dead, rotten or crossed branches are present or to maintain a clear stem up to the specified height using the methods described below. Allowances are to be made for all shrubs and climbers to be pruned at least twice during the Maintenance Period to promote bushy growth and good flowering characteristics. The shrubs shall be checked and all dead wood, broken, damaged or crossed branches shall be cut back, depending on species. Allowances must be made for the regular pruning of dead and dying plant parts. Pruning and removal of branches are to be carried out using sharp and clean instruments to give a clean, sloping cut with one flat face. Ragged edges of bark or wood are to be trimmed with a sharp knife. Dead wood and broken or badly bruised branches shall be removed. Main leaders shall not be cut. Pruning shall be done with clean and sharp tools to produce a clean-cut face.
- e. Topdressing/ Mulching - plant with exposed root planting beds and turfing with low topsoil level and those affected by rainwater splashing and erosion

shall be topdressed a minimum of every three months or as instructed. A mulch can reduce the amount of water loss through surface evaporation, weed generation and soil erosion. All planting beds must be mulched with coco peat with a minimum depth of 75mm every three months or as instructed. Mulch should not touch the stem of a plant or cover the foliage in any situation.

- f. Spraying of plants - all foliage and flowering plants must be sprayed with a fungicide, miticide and an insecticide once every two weeks or as directed by the Landscape Architect. Trees are to be sprayed with the proper pesticide when required.
- g. Fertilizing of plants - slow release of NPK (nitrogen, phosphorus, potassium) combined with fast release organic fertilizer shall be applied regularly to ensure healthy growth, repeating the application once every four to six weeks. All trees, foliage and flowering plants are to be given fertilizer according to the following dosage, fertilizer type:

(A) Trees/Palms (NPK - 15:15:15)

<u>Age Group</u>	<u>Application Rate</u>
1-3 yrs.	2 kg/plant per year in two applications <ul style="list-style-type: none"> • 1 kg each time
3-5 yrs.	4 kg/plant per year in three applications <ul style="list-style-type: none"> • 1.3 kg each time
5 yrs. and above	6 kg/ plant per year in three applications <ul style="list-style-type: none"> • 2 kg each time

The Plant Installer shall put manure on every tree each month with slow releasing fertilizer, recommended and approved by the Landscape Architect.

(B) Shrubs/ Climbers/ Foliage/ Groundcovers

Height of Plants	Application Date	Remarks
1 m ht	35g/plant per month	NPK:15:15:15 and 1-12:12:17 as and when Directed by the Landscape Architect
1-1.5 m ht	50g/plant per month	
1.5 m ht	65g/plant per month	
Flower bed	70g/meter per month	

- h. Replacement of Plant - all poor conditioned, dying and dead plants and turf not growing properly are to be replaced by healthy plants of the same species as specified and size of those adjacent in the planting area during the maintenance period at the Plant Installer's expense.
- i. Maintenance of Turf After Laying:
- j. The Plant Installer shall remove and replace any portion of turfed area where the turf fails to become established within thirty days of turfing.
- k. The Plant Installer shall regularly maintain all turfed areas in a neat manner by watering, moving, ranking and clipping during the whole of the Maintenance Period. All turfed areas shall be moved after one month of completion of turfing, and thereafter at maximum intervals of three weeks.

- I. About one month after planting, the grass shall be applied with manure with a complete chemical fertilizer which supplies Nitrogen, Phosphorus, Potassium and Magnesium approximately in the following proportion 18:12:6:3. This shall be applied at rate of 125 kg/ha of grass after all weeds have been removed. The fertilizer shall be mixed with the topdressing and spread evenly over the field. This application shall be repeated after three months.

7.3.9 Clean-up



- a. The Plant Installer must ensure that all plant beds are tidied up and free from any debris or unapproved plant materials immediately on completion of the planting works.
- b. All areas affected by horticulture activities must be thoroughly cleaned of soil stains, etc. removed to the satisfaction of the Landscape Architect.



7.3.10 Final Planting Inspection and Acceptance of Works

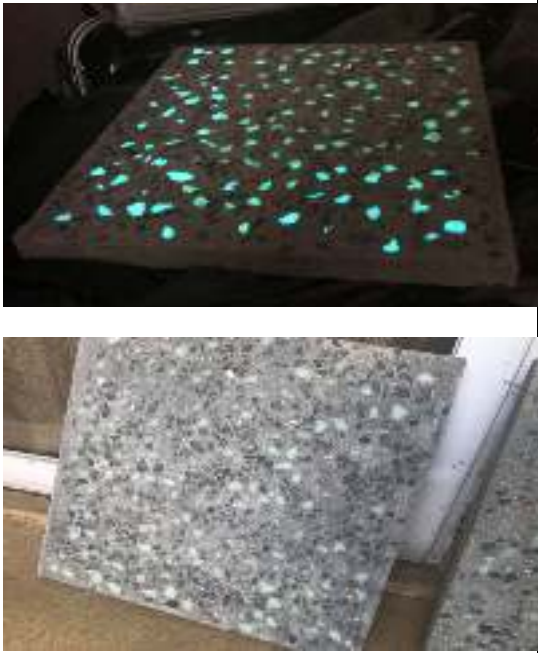

- a. Final inspection for acceptance shall be made at the conclusion of maintenance period provided that all the projects improvements and corrective work has been complete. If improvements are not complete, maintenance shall be continued until completion of such work.
- b. If the Plant Installer fails to complete the final planting after notification by registered mail, the Landscape Architect reserves the right to take the work out of the sub-contract and rectify the work. All charges for rectification shall be at the Plant Installer's expense.
- c. Written notice requesting final inspection shall be submitted by the Plant Installer to the Landscape Architect at least fifteen (15) days before the anticipated date of completion.
- d. Prior to handing over of the work at contract completion and at the end of the Maintenance Period, all plants must be groomed and neatly trimmed to show off their best for the purpose of inspections.



SUMMARY OF MATERIALS AND FINISHES



LANDSCAPE ARCHITECTURAL		SPACE NOS.	AREA OF APPLICATION	REMARKS
ITEM NO.	MATERIALS			
I	PAVING FINISHES			
	A. Texture Homogenous Tile (Granite Tile)			
	0.20m x 0.40m, 0.20m x 0.20m		Urban Streetscape Walkway Paving Banding	Non-skid; gray
	0.40m x 0.60m		Urban Streetscape Walkway Typical Paving Mainfield	Non-skid; dark gray
	0.20m x 0.20m		Urban Streetscape Walkway Typical Paving Mainfield	Non-skid; dark gray



	B. Concrete Paver (Plank Paver by Quality-Star Concrete Solutions or Approved Equivalent)			
	0.1250m x 0.368m x 0.05m thick		Urban Streetscape Walkway Typical Paving Mainfield	On sand setting
	C. Exposed Aggregate Concrete Finish with Glow-in-the-dark Aggregates (Cypress Bomanite Philippines or Approved Equivalent)			
			Urban Streetscape Bikeway	Gray
II	PLANT MATERIALS			
	A. Tree/Palm			
	<p>“Acacia mangium” (MANGIUM)</p> 			See Planting Plan for specifications



	<p>“Alstonia scholaris” (DITA)</p> 			<p>See Planting Plan for specifications</p>
	<p>“Bucida sp.” (PHILIPPINE TALISAY)</p> 			<p>See Planting Plan for specifications</p>
	<p>“Cassia philipinensis” (PALAWAN CHERRY)</p>  <p>“Lagerstroemia speciosa”</p>			<p>See Planting Plan for specifications</p>



	<p>(BANABA)</p> 			<p>See Planting Plan for specifications</p>
	<p>“Livistonia philippinensis” (ANAHAW)</p> 			<p>See Planting Plan for specifications</p>
	<p>“Michelia champaca” (GOLDEN CHAMPACA)</p> 			<p>See Planting Plan for specifications</p>



				<p>See Planting Plan for specifications</p>
	<p>“Peltophorum pterocarpum” (YELLOW PONCIANA)</p> 			<p>See Planting Plan for specifications</p>
	<p>“Petersianthus quadrialatus” (TOOG)</p> 			<p>See Planting Plan for specifications</p>

	<p>“Plumeria rubra” (RED KALACHUCHI)</p> 			<p>See Planting Plan for specifications</p>
	<p>“Spathodea campanulata” (AFRICAN TULIP TREE)</p> 			<p>See Planting Plan for specifications</p>
	<p>B. Shrubs</p>			
	<p>“Crinum xanthophyllum” (YELLOW CRINUM)</p> 			<p>See Planting Plan for specifications</p>

	<p>“Bougainvillea ‘Mary Palmer’” (MARY PALMER)</p> 			<p>See Planting Plan for specifications</p>
	<p>“Hymenocallis littoralis” (SPIDERLILY)</p> 			<p>See Planting Plan for specifications</p>
	<p>“Philodendron selloum” (SELLOUM)</p>  <p>“Calathea lutea”</p>			<p>See Planting Plan for specifications</p>

	<p>(CIGAR PLANT)</p> 			<p>See Planting Plan for specifications</p>
	<p>“Iris pseudacorus” (YELLOW IRIS)</p> 			<p>See Planting Plan for specifications</p>
	<p>“Alocasia odora” (NIGHT FRAGRANT ELEPHANT EAR)</p> 			<p>See Planting Plan for specifications</p>

	<p>“Costus spectabilis” (RED COSTUS)</p> 			<p>See Planting Plan for specifications</p>
<p>C. Ground Cover</p>				
	<p>“Wedelia trilobata” (WEDELIA)</p> 			<p>See Planting Plan for specifications</p>
	<p>“Arachis pintoii” (PEANUT PLANT)</p> 			<p>See Planting Plan for specifications</p>

	<p>“Ipomoea pes-caprae” (BEACH KANGKONG)</p> 			<p>See Planting Plan for specifications</p>
	<p>“Paspalum cv.” (FROG GRASS)</p> 			<p>See Planting Plan for specifications</p>
<p>III</p>	<p>LIGHTINGS</p>			

SPL 1200-2

Supply and Install 6.0m High Pedestrian Lamp Post Double Arms with 70W Luminaire @ 30m On center. Including Concrete Pedestal and Ground Rod with Clamp. (Theos by Performance in Lighting)

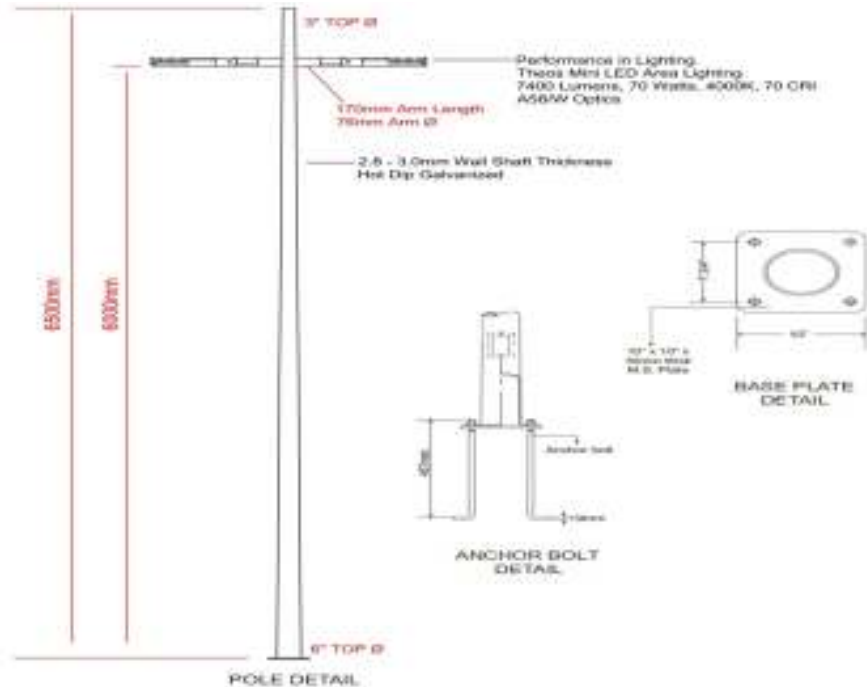

SBP 06222196 THEOS MINI/A58/W 8-40K-96/70W
 Article No.: 06222196
 Luminous flux (Luminaire): 7464 lm
 Luminous flux (Lamps): 7463 lm
 Luminaire Wattage: 69.0 W
 Luminaire classification according to CIE: 100
 CIE flux code: 25 67 97 100 98
 Fitting: 1 x 06222196 (Correction Factor 1.000).

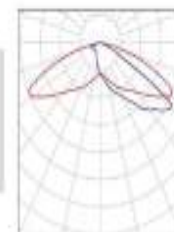

Theos Mini Lighting Fixture by Performance Lighting/LGC Electric or Approved Equivalent

IV	IRRIGATION			
	Quick Coupler Valve			

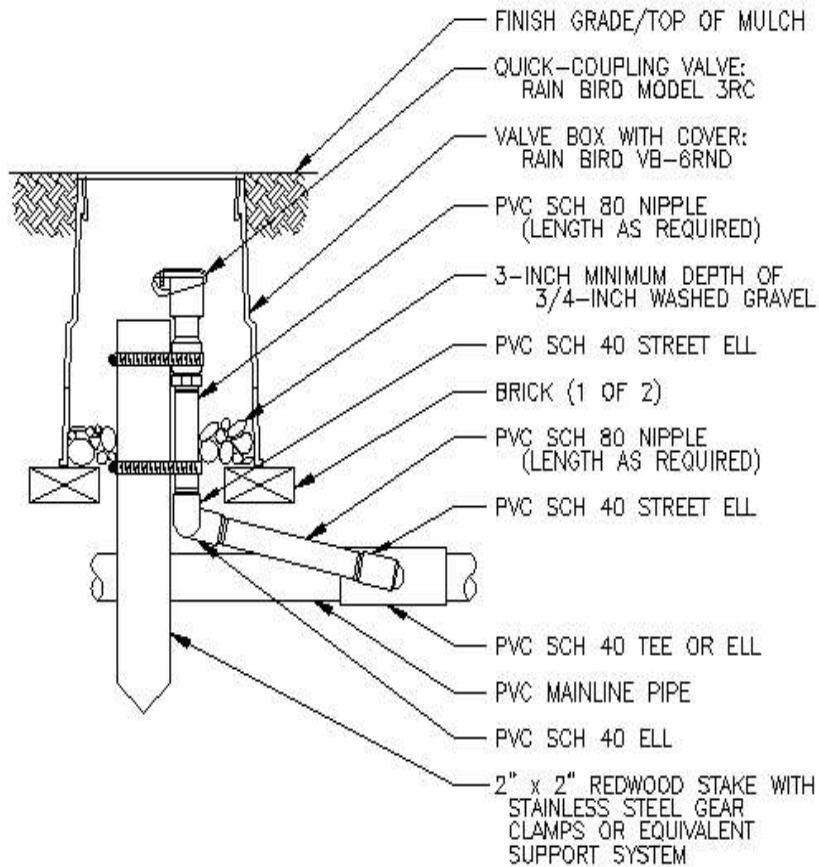

NOTE:
FURNISH FITTINGS AND PIPING NOMINALLY SIZED IDENTICAL TO
NOMINAL QUICK COUPLING VALVE INLET SIZE.



QUICK COUPLING VALVE
N.T.S. **MODEL 3RC**

1-27-04

QC-3RC.DWG

Quick Coupling Valve-3RC by Rain Bird or Approved Equivalent

PART J

STREETLIGHTS AND AREA LIGHTINGS

PART J – STREETLIGHTS AND AREA LIGHTINGS**ITEM 103 STRUCTURAL EXCAVATION****103.1 Description**

This Item consists of the necessary excavation for foundation of bridges, culverts, under drains, and other structures not otherwise provided for in the Specifications. Except as otherwise provided for pipe culverts, the backfilling of completed structures and the disposal of all excavated surplus materials, shall be in accordance with these Specifications and in reasonably close conformity with the Plans or as established by the Engineer.

This Item shall include necessary diverting of live streams, bailing, pumping, draining, sheeting, bracing, and the necessary construction of cribs and cofferdams, and furnishing the materials therefore, and the subsequent removal of cribs and cofferdams and the placing of all necessary backfill.

It shall also include the furnishing and placing of approved foundation fill materials to replace unsuitable material encountered below the foundation elevation of structures.

No allowance will be made for classification of different types of material encountered.

The Contractor shall be guided by the construction requirements defined under work sub-items 103.2.1 – 103.2.7 of the DPWH Standard Specifications for Public Works and Highways, 2013 Edition: Volume II Highways, Bridges and Airports.

103(1) a - Structure Excavation (For Streetlight Concrete Pedestal)**104 (7) - Structure Backfill (From Common Excavation)****SPL 1000 - Light Pole Concrete Footings (For Streetlight Concrete Pedestal)**

All electrical light pole footings shall be reinforced concrete with dimensions as indicated on the Plans. Concrete shall be Class “A” and together with the reinforcing steel shall conform to the requirements of the DPWH Standard Specifications for Public Works and Highways, 2013 Edition: Volume II Highways, Bridges and Airports.

SPL1000-1 Removal of Existing Street Light Post (Including Pedestal, Post & Light)**SPL1000-2 Removal and Relocation of Existing Concrete Electrical Post with Complete Accessories****SPL1000-3 Construction of Steel Pole Concrete Pedestal, 25mm x 762mm Including Rebars, Anchor Bolts with Nuts & Washers**

ITEM SPL 1100 STREET LIGHTING SYSTEM**SPL 1100.1 Description**

The item shall consist of furnishing and installing the street lighting system as required by the Plans and as described in this Specification. The work shall include the following:

- a. Electrical services, including all conduits, junction boxes, fittings, and wiring from the Power Utility Company supply and meter to lighting panel boards, and poles with luminaries.
- b. Lighting panels
- c. Complete street luminaries
- d. Lighting Standard poles and foundation
- e. Cable trench, excavation and backfilling

SPL 1100.1.1 Material/Product Requirements**1. General Requirements**

All materials and equipment to be used and to be installed shall be new and of the approved type bearing the stamp of approval of the Underwriter's Laboratories, Inc.

From General Notes, power service voltage or Utility transformer shall be provided by Others, not by the contractor, estimate a "service lateral towards nearest utility handhole which shall be not more than 30meters away.

But primary distribution line, poles and pole line hardwares are for the Contractor's scope of works.

Fungus Control

No substitute will be accepted, unless the materials and equipment specified herein are not available. Locally manufactured and/or any other substitute materials and equipment may be accepted, provided they are better or the full equivalent in design, quality and size of materials and workmanship, and provided further they carry the written approval before they are installed.

All electrical equipment and materials except otherwise specified shall be treated to resist moisture and fungus. Electrical components such as switches, breakers, fuses, contacts, and heater elements shall not be treated. Other materials and components, which are inherently fungus – resistant or protected by hermitically sealing, need to be treated.

All other circuit elements that have a temperature rise of not more than 30⁰ C when operating at full load shall be coated with a fungus-resistant varnish. Circuit elements include but are not limited to cables, wires, contractors, panels, terminals and terminal junction block capacitors and coils.

Circuit Breakers

The molded case circuit breakers shall be of the thermal magnetic type having inverse-time tripping characteristics on overload and instantaneous trip on short circuits, shall be equipped with arc quenches, shall have quick-make and quick-break toggle mechanism, shall have trip-free operating handles. Each multi-pole breaker shall have a common trip so that an overload on one pole will automatically cause all poles of the breakers to

open. The circuit breakers shall have an interrupting rating of not less than 10,000 symmetrical amperes at 400 volts.

2. Street Lighting Poles and Luminaries

Pole

Provide Lighting Standard Poles designated for wind loading of 100 kilometers per hour determined in accordance with AASHTO LTS-2 while supporting luminaries having effective projected areas indicated. Poles shall be anchor-base type designated for use with underground supply conductors. Galvanizing shall be in accordance with the requirements of ASTM A-120 for the poles and A-153 for the fittings. Effective height shall be 12.0m, mast length equals 3.0m, round tapering.

Luminaires

Technical Specifications, 120Watts, LED Road Lighting, Operating Voltage 100-277VAC Volts, 100 lumens per watt or higher; 12,000 lumens; IP66; Lumen maintenance: 50,000 Hrs; Upgradeable Multi-layer Optics; UV treated; Thermally hardened tempered glass cover; Auto Dimming Function with a dimming percentage of 40.00%; High pressure die-cast aluminum with heat management system; Power Factor: 0.90 or higher; Electrical Insulation: Class 1; Surge Protection: 10kV; Color Temperature: 3500k to 4000k Maintenance: Replaceable Gear Tray, upgradeable / replaceable LED modules, SPD and driver, tool less luminaire opening and gear tray change; Warranty: 5 years warranty for LED system (LED / driver /optics / luminaire). Rectangular in shape.

As per the Electrical Drawings, Riser/Lighting Panel Wiring Diagram specified that the Roadway Luminaires are manually control on individual circuit breaker; LTG Control Options: Standalone Dimming Program, Telemanaged City Touch, Star Sense and AmpLight compatible. NEMA and D2 Type PE Cell must be provided by the Contractor. This feature is already included in the Modern LED Lighting Luminaire package.

Compliance with the Energy Efficient LED Streetlight Specifications and with the following LED Quality Industry Standards compliance requirements:

1. EN 61347-1: general and safety requirements;
2. EN 61347-2-13: particular requirements for DC or AC supplied electronic control gear for LED modules;

3. EN 62384: DC or AC supplied electronic control gear for LED modules performance requirements;
4. EN 55015: 2006 and 2007-Limits and methods of radio disturbance characteristics of electrical lighting;
5. EN 61547: 1995/+A1: 2000- Equipment for general lighting purpose EMC immunity requirements;
6. EN 61000-3-2:2006 - Limitation of harmonic current emission;
7. EN 61000-3-2:2008 - Limitation of voltage fluctuation and flicker;
8. IEC 60598-1(Ed7) general requirements for luminaires, incorporating electric light sources for operation from supply voltages up to 1000V;
9. IEC 60598-2-3 (Ed 2) - Electric Insulation Class I;
10. IEC 62471 photo-biological safety of lamps and lamp systems;

Compliance with the Test Reports and Certifications from laboratories that are accredited according to ISO/IEC 17025 and qualified for pertinent testing of LED products particularly for roadway lighting by a recognized national or regional accreditation body (ILAC/APLAC) and to be submitted prior to delivery of streetlights.

1. Technical Data of luminaire and driver.
2. LM-70 Test Report(for luminaire electrical/photometric properties);
3. LM-80 Test Report (for LED chip properties);
4. Lumen Depreciation Test Report at 1000, 2000 and 3000 burning hours;
5. IEC 60598 Test Report;
6. Vibration Test Report;
7. EMC Test Report;
8. Salt Spray Test Report;
9. Factory ISO Certificate (ISO 9001: 2008/ISO 14001: 2004/ISO 18001: 2007); and
10. Lux Meter Test Results.

ENERGY EFFICIENT LED STREETLIGHT SPECIFICATIONS

1. LED Streetlight Luminaire Housing

The luminaire shall have a full die cast housing to provide adequate rigidity and strength and also ensure proper heat dissipation. The luminaire housing shall have separate Driver and LED lamp cavity to ensure cooler operation of LED lamps and good electrical separation.

The optical LED compartment shall have a thermally hardened glass cover and high quality silicon gasket system. The glass cover shall be tightly secured with the housing. The complete luminaire shall be rated for IP 66 (Ingress Protection).

2. Optics

Specially designed lens system with unique inner and outer profile for high efficiency LED to ensure maximum spacing between the poles and cover higher road widths. Multi-layer optics designed to ensure adequate luminance and illuminance uniformity in the unlikely event of individual LED failure. The luminaire should offer choice of narrow beam, medium beam and wide beam light distribution.

The luminaire shall offer a composite system efficiency of at least 100 Lumen/Watt and a lumen package of no less than 12,000 lumens. The luminaire shall use high efficiency LED and optics system to achieve at least 50% energy savings compared to present High Pressure Sodium road-lighting system (including ballast).

3. Future Compatibility

The luminaire shall be fully compatible with future LED upgrades when they become available. It shall have a modular design to upgrade / replace with new LED modules or LED drivers at site. All electronic components/drivers shall be mounted on a separate gear tray with tool-less access and replacement. The luminaire shall have space available inside for communications antenna or equipment to be integrated into the luminaire for future telemanagement control system implementation. Evidence showing telemanagement capability shall be provided.

4. Surge Protection

The proposed luminaire shall have an in-built 2-stage surge protection system to protect (1st stage) the electronic driver and (2nd stage) the LED module with a minimum surge protection rating of 10KV.

5. Ingress Protection (IP) & Impact Resistance

The luminaire shall have Full IP 66 protection to ensure long reliable performance and to minimize maintenance requirement and an Impact resistance of IK 08. No chemical glue is to be used as it may cause breakdown of water-proof and dust-proof seal.

6. Maintenance

The driver compartment cavity and gear tray shall be designed with tool-less access for maintenance and replacement.

7. Mounting

The mounting of the luminaire will be in axial orientation through Ø 48-60mm sidearm.

8. Thermal Management

Managing thermal properties in LED luminaires are most critical to ensure optimum performance of LEDs and reliability of the system.

The housing shell under the circuit board (PCB) should be specially designed to ensure perfect contact between the board and the luminaire housing for efficient heat dissipation. The PCB shall be designed to maximize heat transfer and should be mounted on the housing using a highly efficient thermal interface material. Use of Silicon glue is not acceptable.

The housing over the Driver compartment cavity shall have adequate surface area to ensure fast heat dissipation.

9. Color Rendering Index and Color Temperature

The luminaire should have a minimum color rendering index (Ra) of 70+/- 10 and a color temperature of 4000K. The LED shall have a color consistency preferably within 5 SDCM at a maximum of 7 SDCM (standard deviation of color matching) as defined by McAdam. The color temperature variation of the LEDs should be restricted as per ANSI C78.377A with CCT variation limiting within 500K for nominal CCT of 4000K.

10. Useful Life Hours

The LED luminaire shall be designed for lumen maintenance of L70 or 70% at the end of useful life at ambient temperature of 35 degree Celsius. The complete luminaire shall have a useful life of 50,000 burning hours. The luminaire including the driver will include a warranty of 5 years against manufacturing defects.

11. Standards Conformity

The luminaire should fully conform to the following specifications (please submit certificate or test report for each):

IEC 60598-2-3 - Part 2: Particular requirements: Sec. Three-Luminaires for road & street lighting

62471 – Photo-biological safety of lamps and lamp systems

IEC 62493 – Assessment of lighting equipment related to human exposure to Electromagnetic Fields

EN 55015: 2006 and 2007 – Limits and methods of radio disturbance characteristics of electrical lighting.

EN 61547:1995 / +A1:2000 – Equipment for general lighting purpose EMC immunity requirements. EN 61000-3-2:2006 – Limitation of harmonic current emission.

EN 61000-3-3:2008 – Limitation of voltage fluctuation and flicker.

12. LED Driver Specifications

The LED driver shall be designed to operate large array of high power LEDs through current controlled output. The driver shall be suitable for nominal 220V-240V 50/60Hz mains supply.

The LED driver shall incorporate multiple control interfaces for dimming capability. It shall enable DALI, & 1-10V DC interface dimming control. It shall also have a programmable feature to allow pre-programming of step dimming lighting levels based on the ON time.

The LED driver shall fully conform to following specifications (please submit certificate or test report for each):

IEC61347-1 - General and safety requirements.

IEC61347-2-13 - Particular requirements for DC or AC supplied electronic control gear for LED modules.

IEC62384 - DC or AC supplied electronic control gear for LED modules

13. Ambient Temperature

The luminaire shall be suitable for ambient temperature range of between -40 to 55 degrees Celsius. 3rd party IEC60598 Test Report shall be measured/corrected for Ta = 35 degrees Celsius.

14. Lighting Simulation

To support and establish the performance of the luminaire relative to the road, a lighting simulation showing compliance to Luminance measurement of 1 cd/m² should be submitted. Overall uniformity measurements shall not be less than 0.40.

a.) Conduit

PVC Conduit shall conform to ANSI Standards. Fittings of types approved by the Engineer shall be provided as required for connection to junction, pull and outlet boxes and to equipment.

b.) Insulated Conductors

Conductors in raceway shall be copper with moisture and heat-resistant rubber or thermoplastic insulation. Wires and cables shall be type THW with nylon jacket for all wires. All types shall be PAS approved and shall conform to NEMA Standard Rubber Insulated Wire and Cable for the Transmission and Distribution of Electrical Energy. Phelps Dodge brand or approved equal shall be used. For circuit ground wire, use TW type thermoplastic heat and moisture resistant.

c.) Grounding Installation

All street lighting poles and panel boards shall be effectively grounded. Conductor and ground wires shall be bare copper as shown and sizes as indicated in the plans. All connections shall be mechanically and electrically sound and secured by insulating tape of approved type. Grounding wire shall be made of bare copper stranded, soft drawn wire and shall be installed in one continuous length without splices or joints.

Ground rods shall be made of copper-clad steel and shall be driven full length into the earth, sizes of which shall be as indicated on the plans for grounding details. Connection to the grounding rod shall be done exothermic weld.

d.) Backfilling Materials

Backfilling materials should be a suitable soil materials and free from any objectionable matters and approved by the Engineer.

e.) Power House Building

The Contractor shall propose for the Power House Building Plan with an area as specified in the specifications as 4.0m x 6m and shall be for approval of the Engineer. Installation and construction of the Fuel Day tank is part of the Power House Building Construction

f.) Pedestrian Lamp Post (on Landscaped Sections)

For Item SPL 1200-2, Part L- Street Landscape (Supply and Install 6.0m High Pedestrian Lamp Post Double Arms with 70W Luminaire@ 0.30m on center, including Concrete Pedestal & Ground Rod with Clamp, is part of the Contractor's scope of work.

The Contractor shall provide for all interconnected wirings, conduits and necessary lighting control panel. As specified in this *Part J, Description 1st Paragraph letter "a"*.

SPL 1100.1.2 Construction Methods

1. General

a. Codes and Regulations

All works shall be done in accordance with the requirement of the latest edition of the PHILIPPINE ELECTRICAL CODE and the NATIONAL SAFETY CODE, with the applicable ordinances of the local government, and with the requirements of the local power company that will eventually furnish the service. Nothing contained herein or shown on the plans shall be constructed as to conflict with the requirements of these codes, which are hereby made part of the work of this item.

b. Contractor Submittals

The Contractor shall be required to submit shop drawings which shall include outline dimensions, mounting connections and clearance, ratings, elementary wiring diagrams, interconnection wiring diagrams, together with catalogs and descriptive data for the following:

- a. Lighting panels
- b. Streetlights, including lighting standard poles
- c. Photocell switch
- d. Manufacturer's Data.

When data that described more than one type, size, model, or item is submitted, clearly mark the data to indicate which type, size, model, or item is being provided. Data shall be sufficient to show conformance to specified requirements:

1. Luminaires
2. Lighting Standard Poles

e. Shop Drawings:

Luminaires: Include dimension, accessories and installation and construction details. Photometric data, including Zonal lumen data, average and minimum ration aiming diagram and computerized candlepower distribution data shall accompany shop drawings.

Poles: Include dimensions, wind load determined in accordance with AASHTO LTS-1, pole deflection, pole class, and other applicable information and pole design calculations.

f. Certified Test Reports:

Luminaires:

1. Computerized horizontal illumination levels in foot-candles or lux at ground level, taken every 3 meters. Include average maintained foot-candle level and maximum ratio. Distribution data according to IES classification type of M-S-III as defined in IES Lighting Handbook. Luminaries not conforming to this standard are not acceptable.

2. Test Guarantee

When the installation is reported as completed and ready for acceptance, the Contractor, at his own expense, in the presence of the Engineer, shall make test as directed.

The Contractor shall supply all apparatus, materials and labor required for making the tests.

The Contractor shall furnish a guarantee covering all labor and materials for a period of one year from the date of final acceptance of his work and he shall agree to repair and make good at his expense any and all defects which may develop during that time, if in the opinion of the Engineer such defects had raised from defective workmanship or materials.

3. Installation

a.) Lighting Panels

The Contractor shall install the panel boards at the locations in proper position and shall be completely wired and ready for operation. All power and control wire and cables shall enter the control equipment enclosure through conduits.

b.) Conduit

Electrical conduits and fittings shall be installed in their correct positions and locations as shown on the plans. Conduit and fittings to be embedded in concrete shall be held securely in position while the concrete is being placed. All threaded conduit connections shall be painted with red lead sealing compound or glyphical varnish.

All conduit bends shall be of standard radii bent without heating and shall be free from kinks, indentions, or other deformations, which reduce the cross-sectional area. Burrs and sharp edges at the end of each piece of conduit shall be removed with a taper reamer. Bend shall not exceed more than 4 quarter bend in laying conduit from boxes to boxes.

Bushing shall be installed on the ends of conduits at boxes or cabinets to protect conductors from abrasion, and locknuts and bond nuts shall be installed to provide tight grounded connections between conduits and boxes.

Conduits emerging from concrete surfaces shall be terminated with conduit coupling and pipe plugs.

During construction, ends of conduits shall be plugged at all outlets or boxes to keep the conduits dry and prevent the entrance of foreign matter into the conduits.

Locknuts and bond nuts shall be installed to provide tight ground connections between conduits and boxes, control board and cabinets. The ends, if conduits are terminating at cabinets, control boards or outdoor boxes, shall be sealed with an approved sealing to prevent air circulation from the conduit into the panel cabinet boxes.

c.) Concrete Foundations

Comply with details for reinforcement and for anchor bolts, nuts, and washers. Verify anchor-bolt template by comparing with actual pole bases furnished.

d.) Pole Installation

Use web fabric slings (not chain or cable) to raise poles. Mount pole to foundation with leveling nuts, and tighten top nuts to torque level recommended by pole manufacturer. Secure poles with level, plumb and square. Grout void between pole base and foundation. Use non-shrinking or expanding concrete grout firmly packed in entire void space. Use a short piece of 13mm diameter pipe to make a drain hole through grout.

e.) Luminaire Attachment

Fasten to indicate structural supports. Lamp luminaries with indicated lamps according to manufacturer's written instructions. Replace malfunctioning lamps.

f.) Field Quality Control

Testing and commissioning shall be in accordance with the manufacturer's recommendations.

Provide necessary testing tools and equipment and to include the following:

- Measure light intensities at night if specific illumination performance is indicated. Use photometers with calibration referenced to NIST standards, or approved equal.
- Check intensity and uniformity of illumination.
- Check excessive noisy ballast.

g.) Excavation and Backfilling

Prior to excavation, all necessary clearance shall be secured in advance for all underground facilities that can be found along cable trench.

Backfilling shall be done in approved manner using suitable excavated materials free from any objectionable matter and place in layers to be compacted thoroughly and evenly using mechanical tamper to a maximum density.

h.) Conduit under Roadway

Installation shall be such as to avoid pocket in the conduit run. All run shall be straight as possible and shall be installed in a neat and workmanlike manner. Conduits under roadway shall be encased in reinforced concrete.

i.) Electrical Conductors and Grounding

Electrical conductors and ground wires shall be furnished and installed by the Contractor. All insulating tape and compounds, solder, flux and connectors for making grounding connections shall be mechanically and electrically tight and secure.

All grounding connectors shall be furnished by the Contractor. The Contractor shall install electrical conductors and shall make all required connections as shown on wiring diagrams to be furnished or as directed by the Engineer. The conductors shall be installed so that there will be no cuts or abrasions in the insulations or protective covering of the conductor. No splices shall be made in conductors, except at boxes, outlets or cabinets.

SPL 1100.1.3 Method of Measurement

The works under this item will be paid for each of the items provided in the Bill of Quantities. Payments shall be full compensation for all materials, labor, plant, equipment, tools and incidentals, including all necessary tests and electrical permits that may be required and all other incidentals necessary to complete the whole electrical lighting system installation and each individual luminaire as detailed in the project drawings.

SPL 1100.1.4 Basis of Payment

The accepted quantities, measured as prescribed in Method of Measurement, shall be paid for at the contract unit price for Part J- Streetlights and Area Lightings for which the price and payment shall be full compensation for furnishings, and installation and placing all materials, including all labor, equipment, tools and incidentals necessary to complete the work prescribed in this Item.

Payment will be made under:

Pay Item Number	Description	Unit of Measurement
103(1)a	Structure Excavation (Streetlight Concrete Pedestal)	Cubic Meter
104(7)	Structural Backfill (From Common Excavation)	Cubic Meter
SPL-1000-3	Construction of Steel Pole Concrete Pedestal, 25mm x 762 mm, Including Rebars, Anchor Bolts with Nuts & Washer	Sets
SPL-1100-1	Supply and Install, 12.0m High Steel Lighting Pole, 3.0m Single Arm, Including Ground Rod with Clamp	Sets
SPL-1100-2	Supply and Install, 12.0m High Steel Lighting Pole, 3.0m Double Arm, Including Ground Rod with Clamp	Sets
SPL-1100-3	Supply and Install, 120W LED Roadway Luminaire, Post Mounting with Copper Split Bolt Connector	Sets
SPL-1100-4	Supply and Install, THW Copper Wire, 22mm ²	Linear Meter
SPL-1100-5	Supply and Install, THW Copper Wire, 8mm ²	Linear Meter
SPL-1100-6	Supply and Install, THW Copper Wire, 3.5mm ²	Linear Meter
SPL-1100-7	Supply and Install, 50mm Φ PVC Pipe with Coupling	Linear Meter
SPL-1100-8	Supply and Install, Enclosed Circuit Breaker, 2P40A 22KAIC, NEMA-4x with 50mm HUB	Sets
SPL-1100-9	Supply and Install, Panel Board, MCB:4P100AT; BRS:10-2P40AT, NEMA-4x	Sets
SPL-1100-10	Supply and Install Synchronizing Panel, 3-45KVA, 3 Φ , 400V, 60HZ, PLC	Sets
SPL-1100-11	Supply and Install Generator Set, Diesel, 45KVA, 3 Φ , 400V, 60HZ Brushless	Sets
SPL-1100-12	Construction of Power House Building, 4m x 6.0m Floor Area	Units
SPL-1100-13	Standard Electrical Handhole, for Service Lateral Connection	Units
SPL-1100-14	Supply and Install, Metered Electric Utility Services for 45KVA, 3 Φ 400V	Units
SPL-1100-15	Contingency Miscellaneous	Lot